

Modelação Geométrica e Generativa

20191121

RAFAELA MARTINS ANTUNES



ÍNDICE

1. QGIS

- 1.1. Mapas
- 1.2. Ampliação Mapa com Autocad

2. Poliedros

- 2.1. Cubo
- 2.2. Dodecaedro

3. Grasshopper

- 3.1. Grasshopper Cubo
- 3.2. Grasshopper Parabolóide
- 3.3. Grasshopper Terreno Hipotético
- 3.4. Grasshopper Terreno de Projeto

4. Conchas Gastrópodes

- 4.1. Spirula
- 4.2. Planorbis
- 4.3. Nautilus
- 4.4. Caracol
- 4.5. Caramujo

5. Conchas Bivalves

- 5.1. Mexilhão
- 5.2. Ameijoa
- 5.3. Vieira
- 5.4. Ostra

6. Concha Caramujo em Grasshopper

7. Corais

- 7.1. Coral Espinhoso
- 7.2. Coral 2
- 7.3. Coral 3
- 7.4. Coral 4 (Espinhoso)

8. Anémone

9. Abóbadas

- 9.1. Abóbada de Berço
- 9.2. Abóbada de Cisterna
- 9.3. Abóbada de Ogiva
- 9.4. Abóbada Abatida
- 9.5. Abóbada Tórica
- 9.6. Abóbada Helicoidal
- 9.7. Luneta Cilíndrica
- 9.8. Luneta Esférica
- 9.9. Luneta Cónica

Exerc. 1 - QGIS

Google Satellite Hybrid:

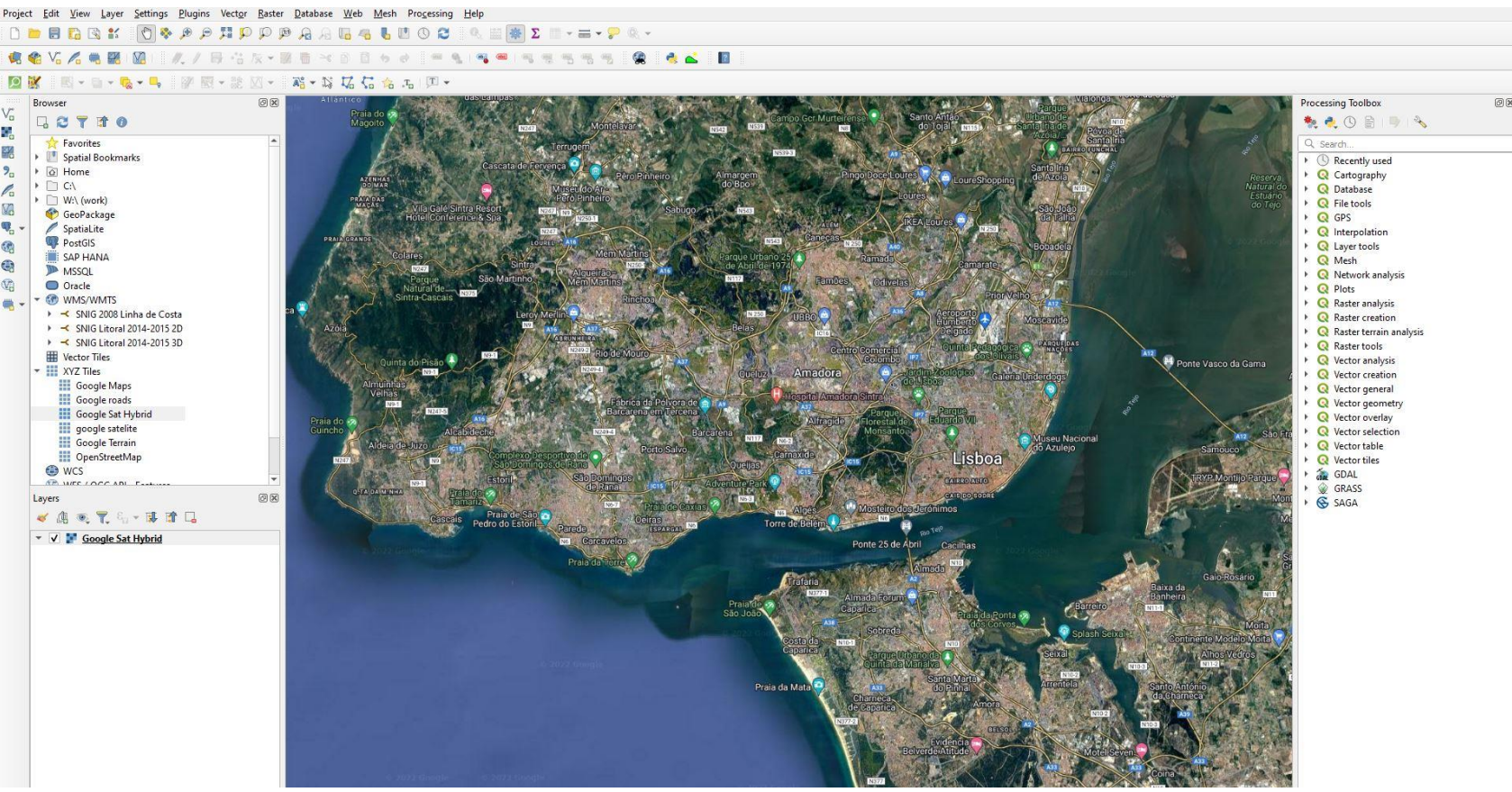

Google Roads:

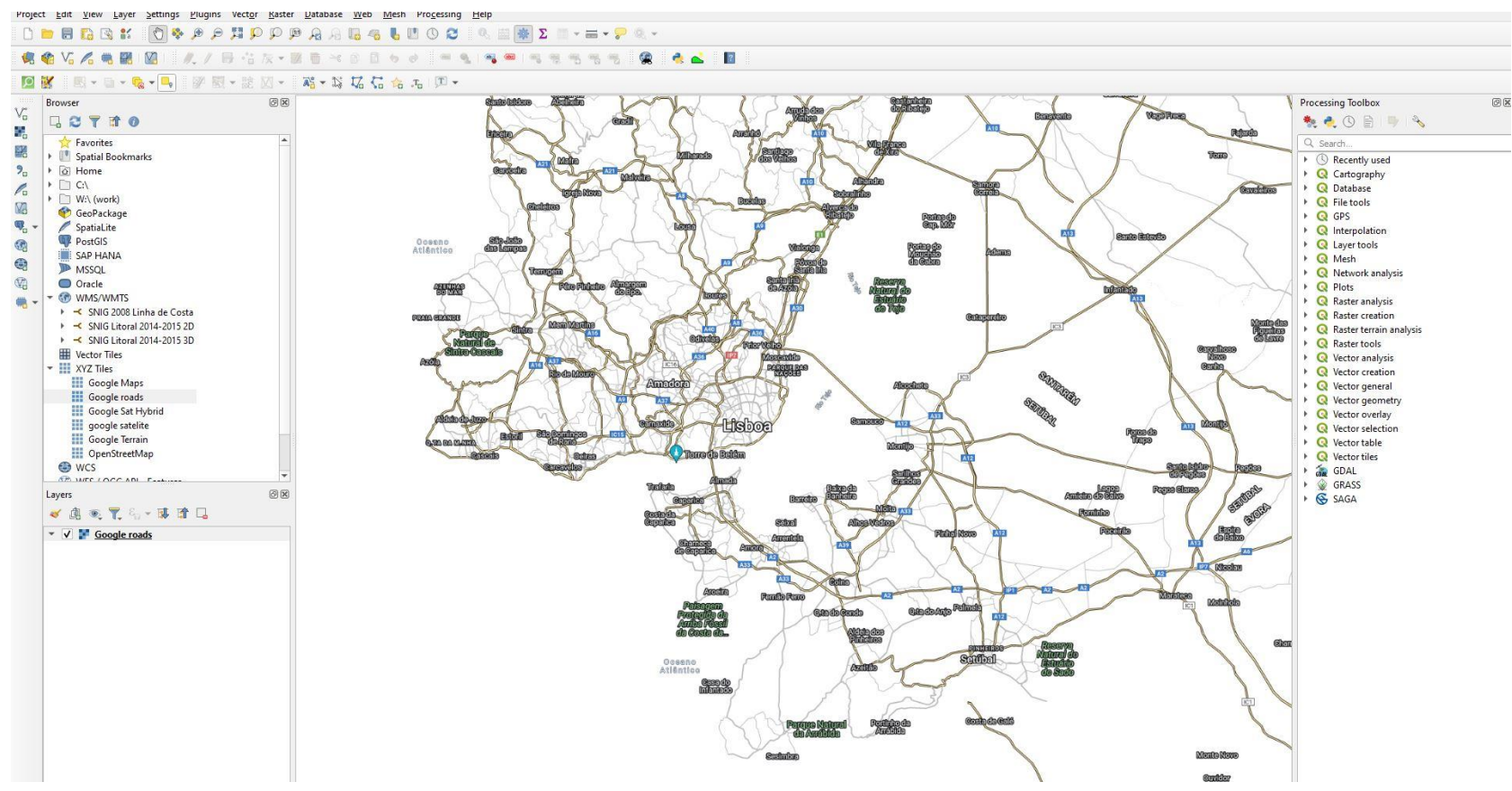

Google Street Maps:

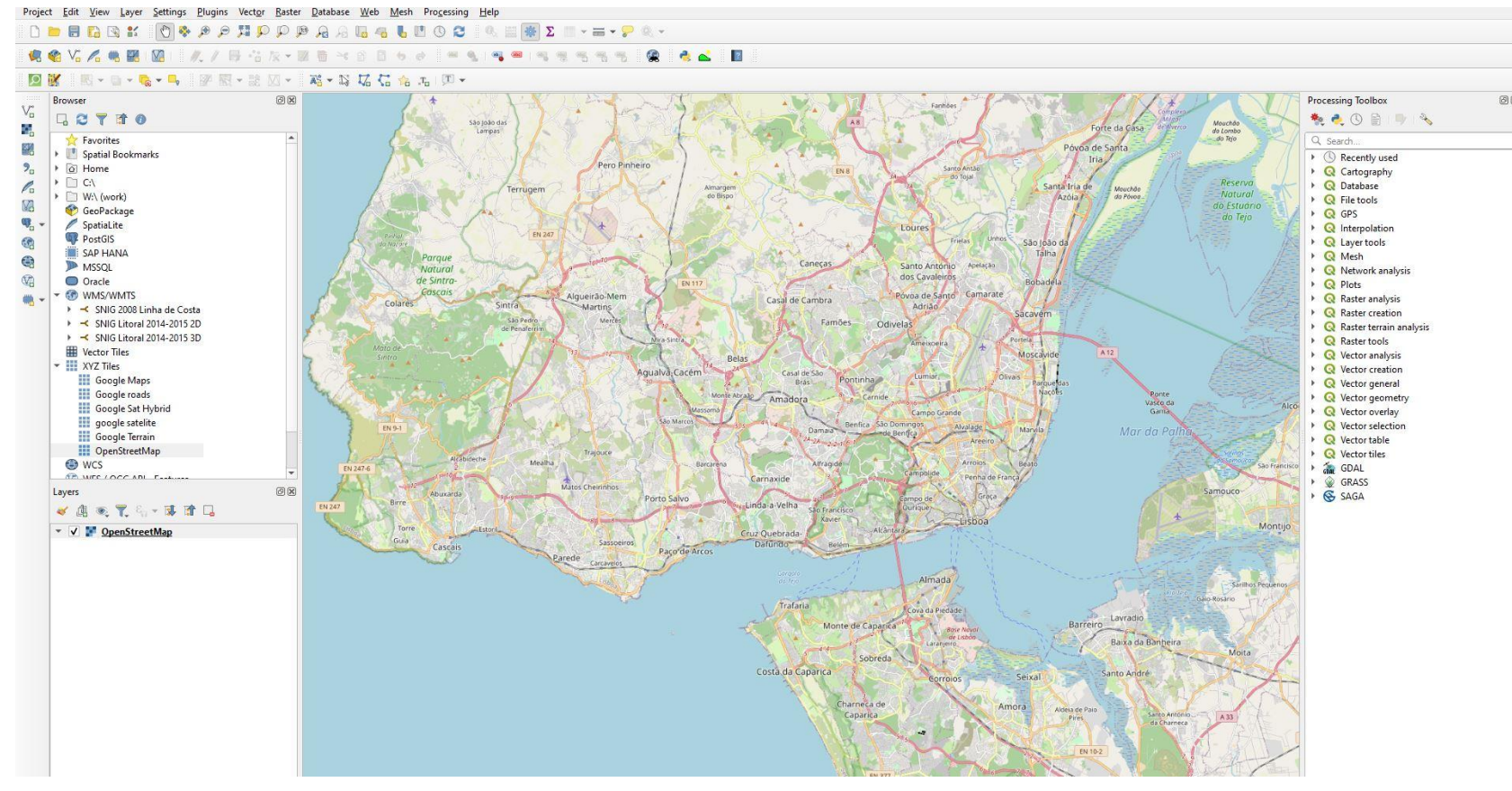

Google Maps:

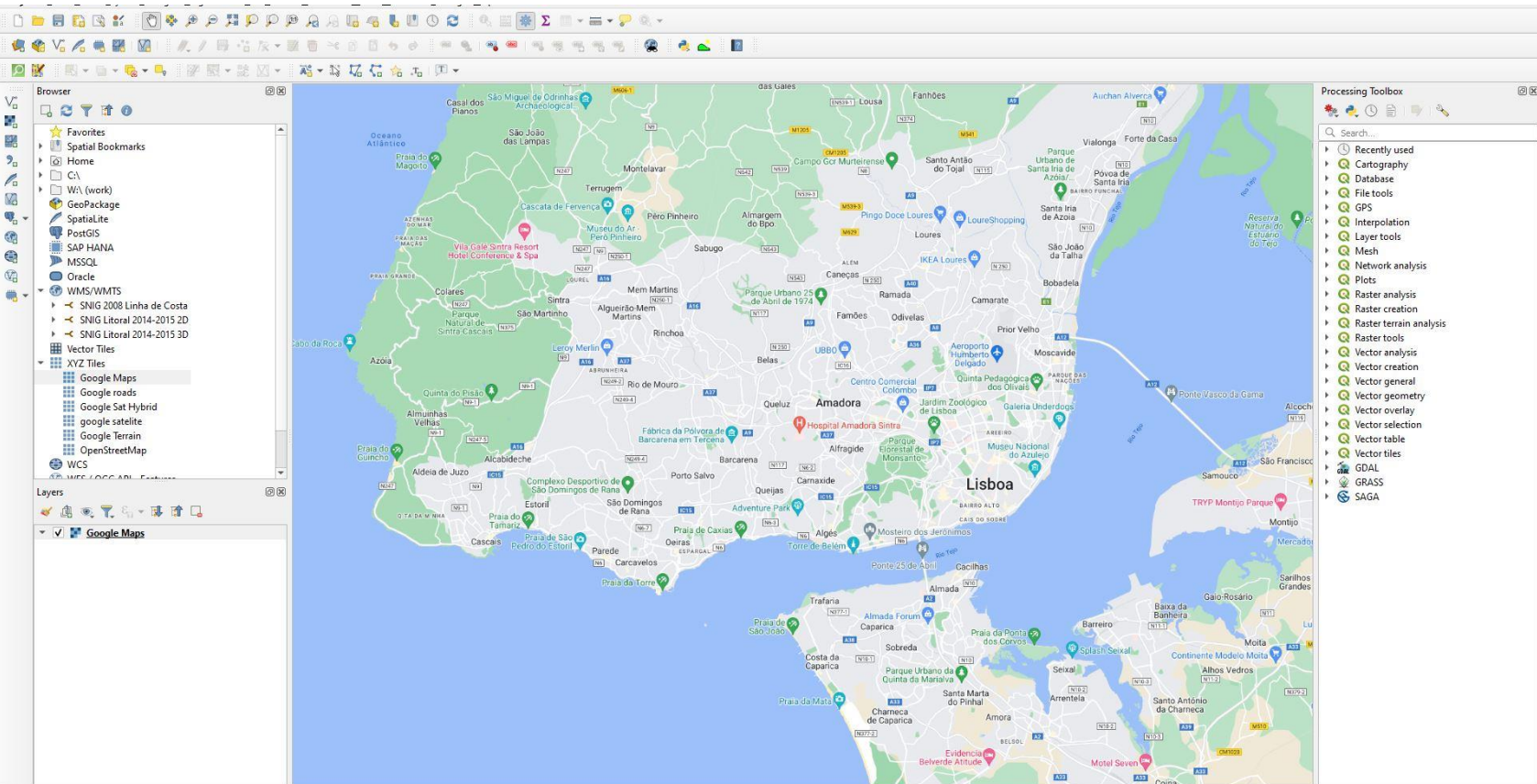

Google Satellite

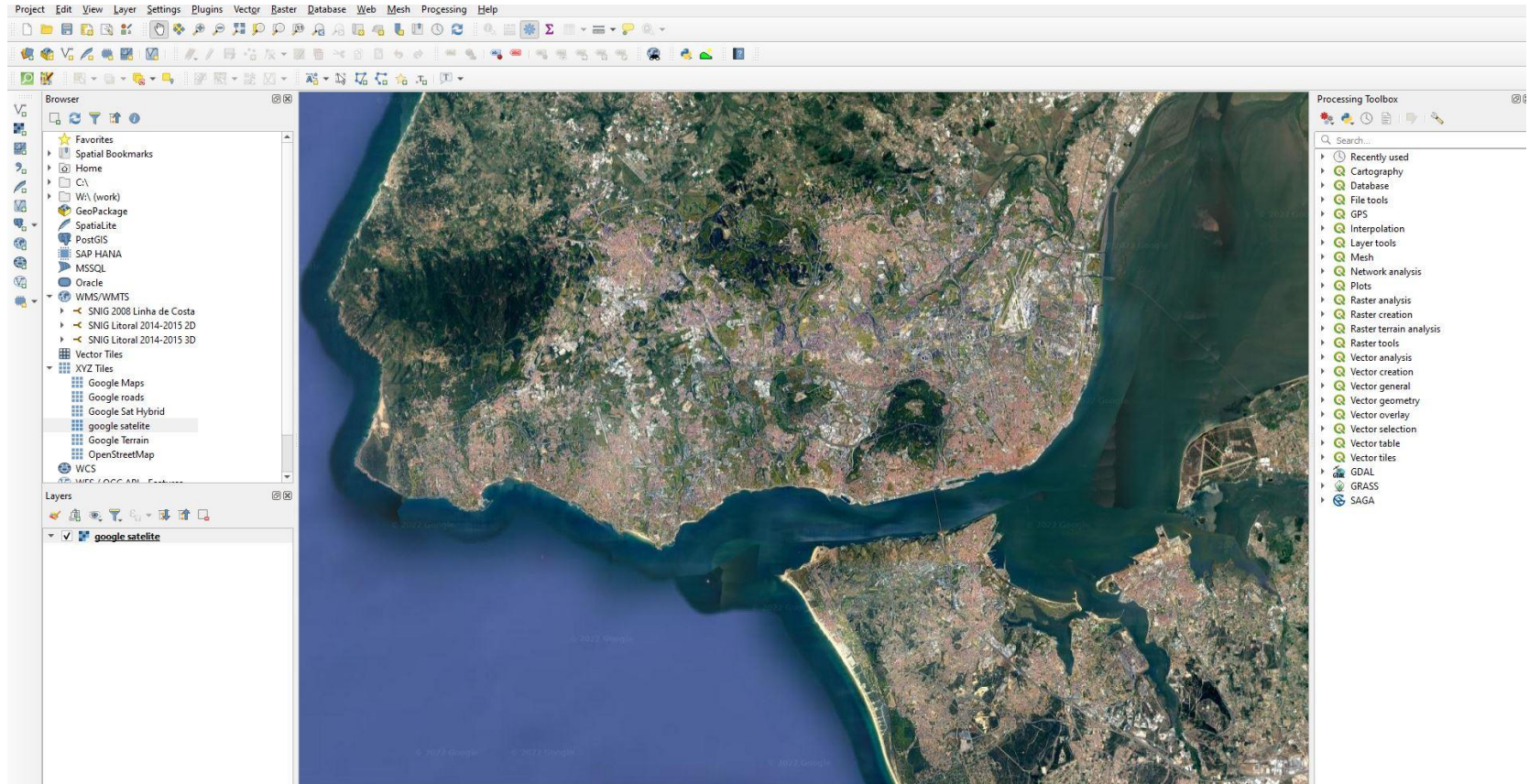

Google Terrain:

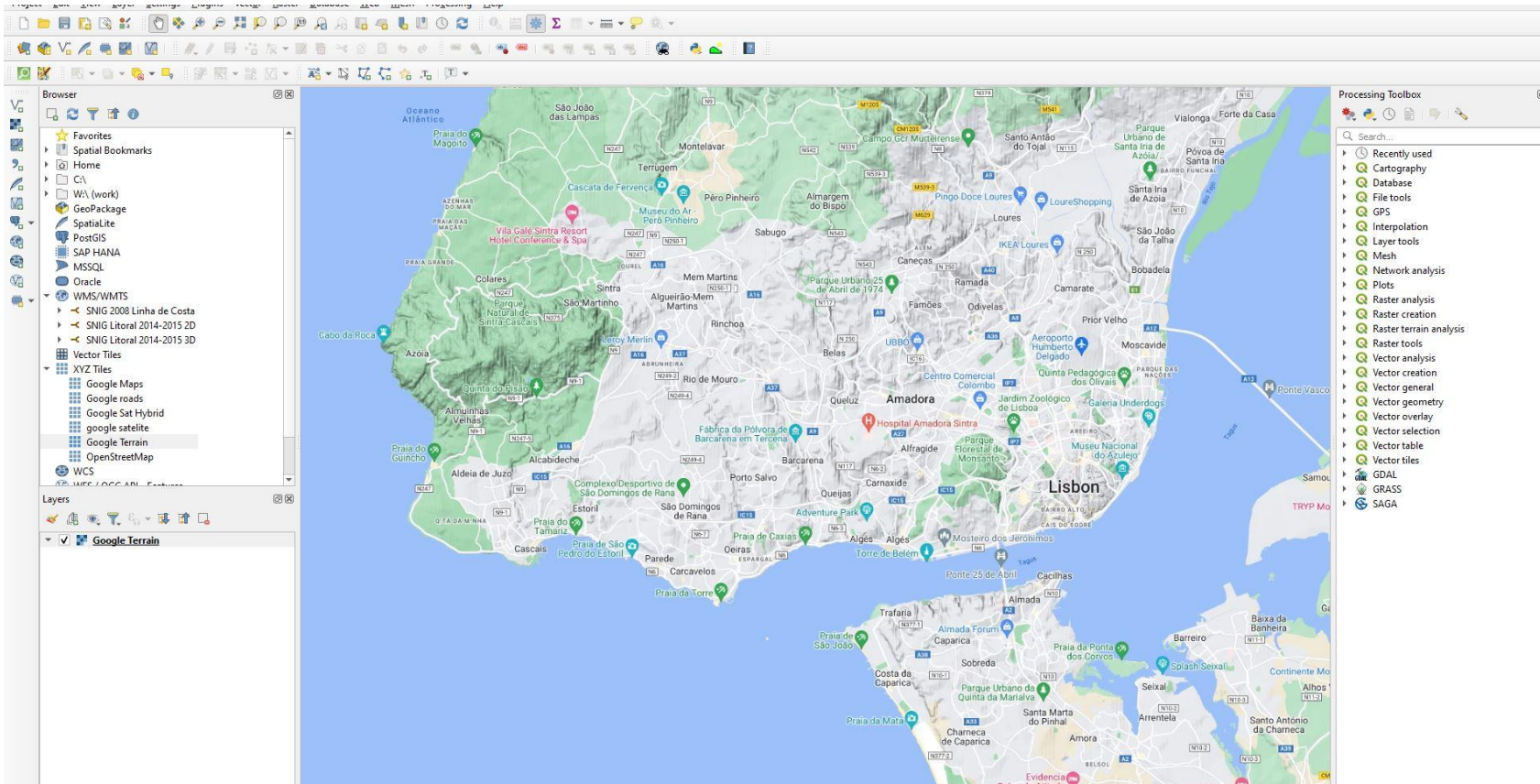

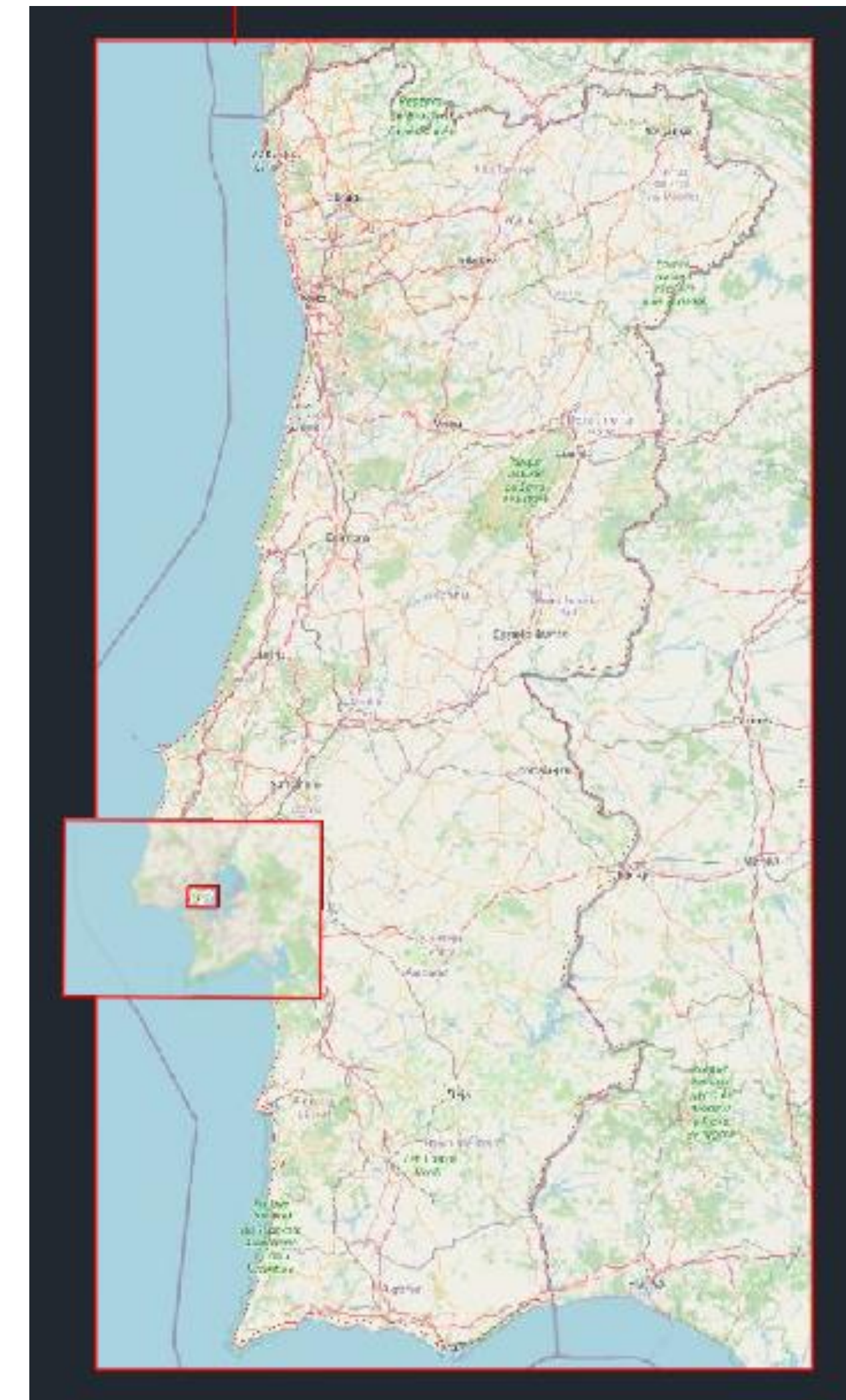
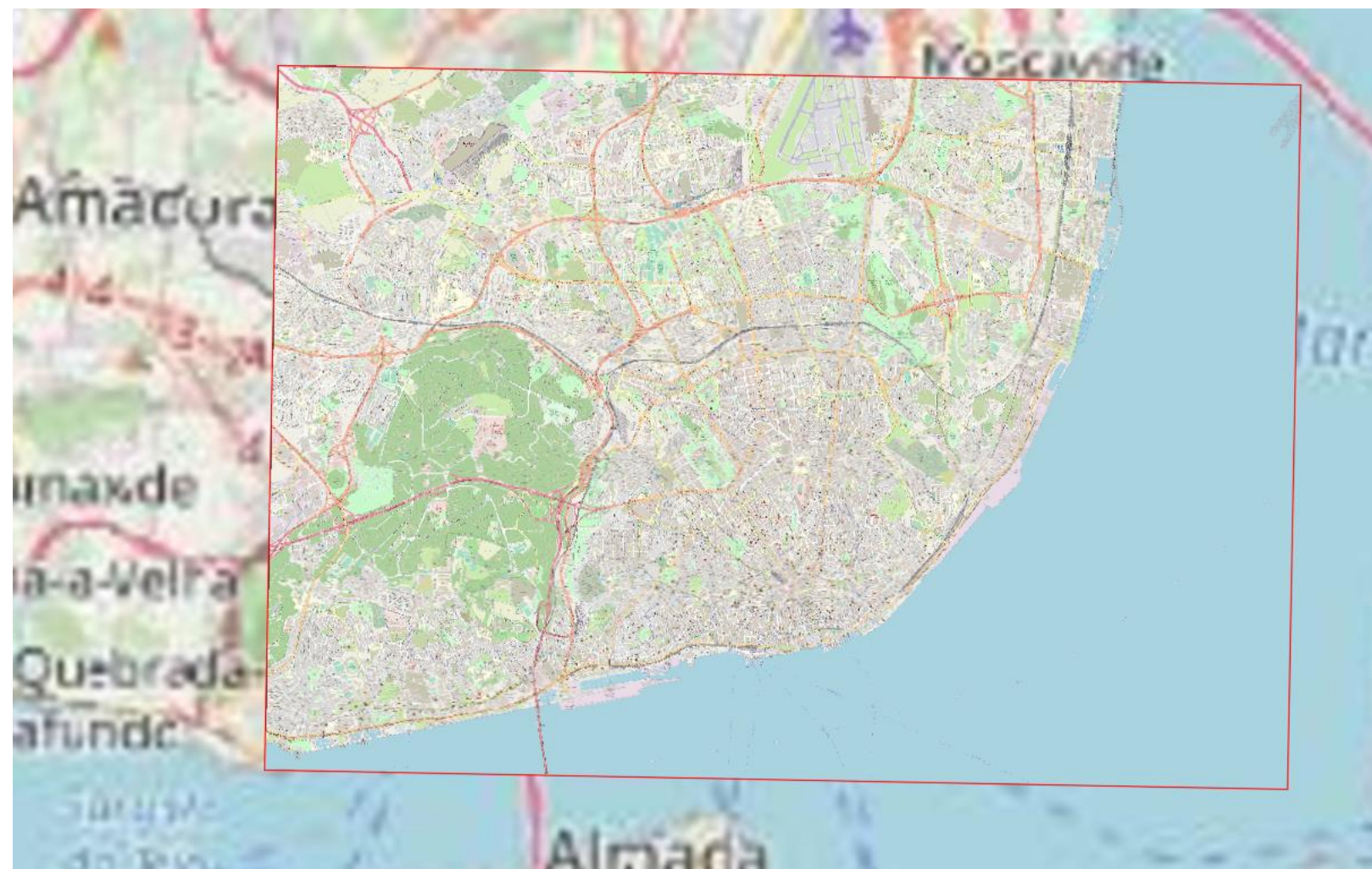
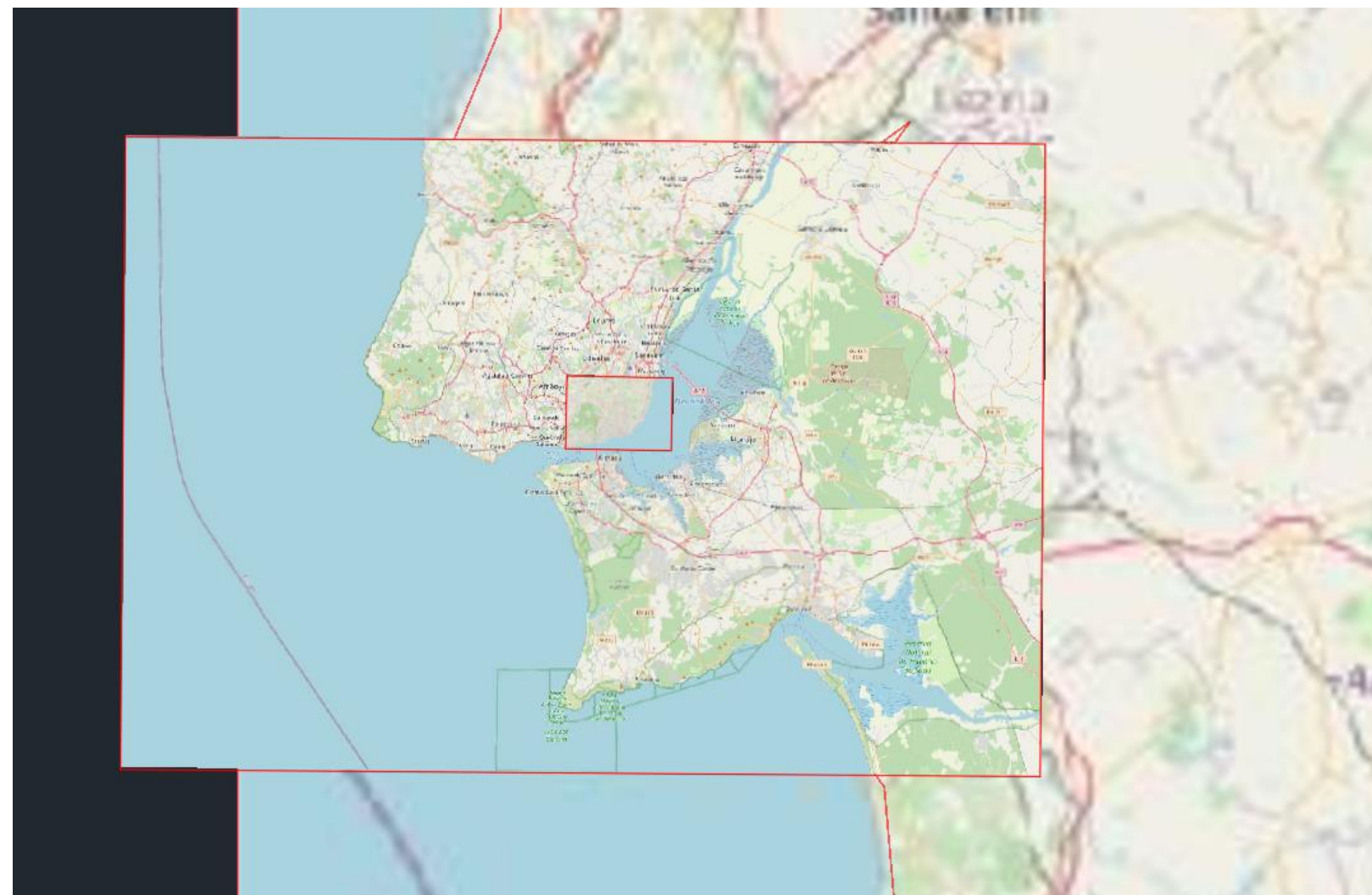

Exerc. 1.2 - QGIS



Exerc. 2 - POLIEDROS

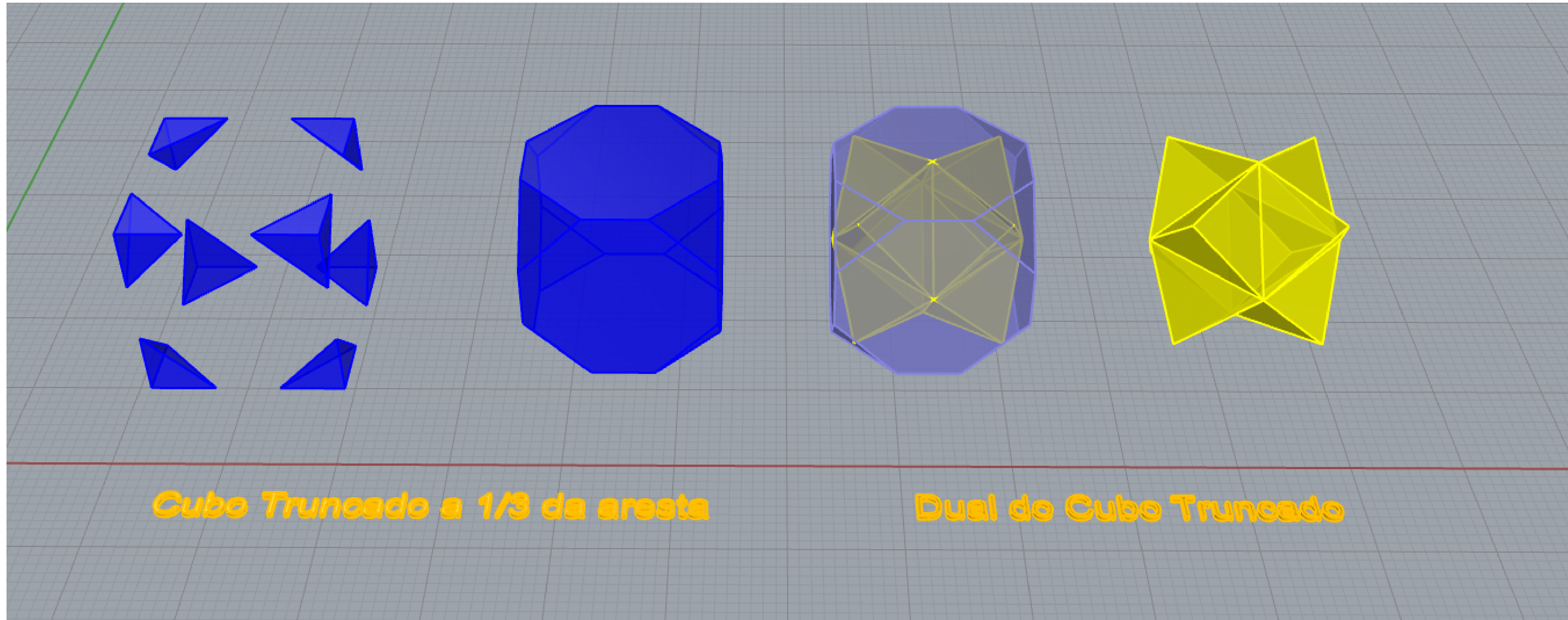

Exerc. 2.1 – Cubo (Processo)

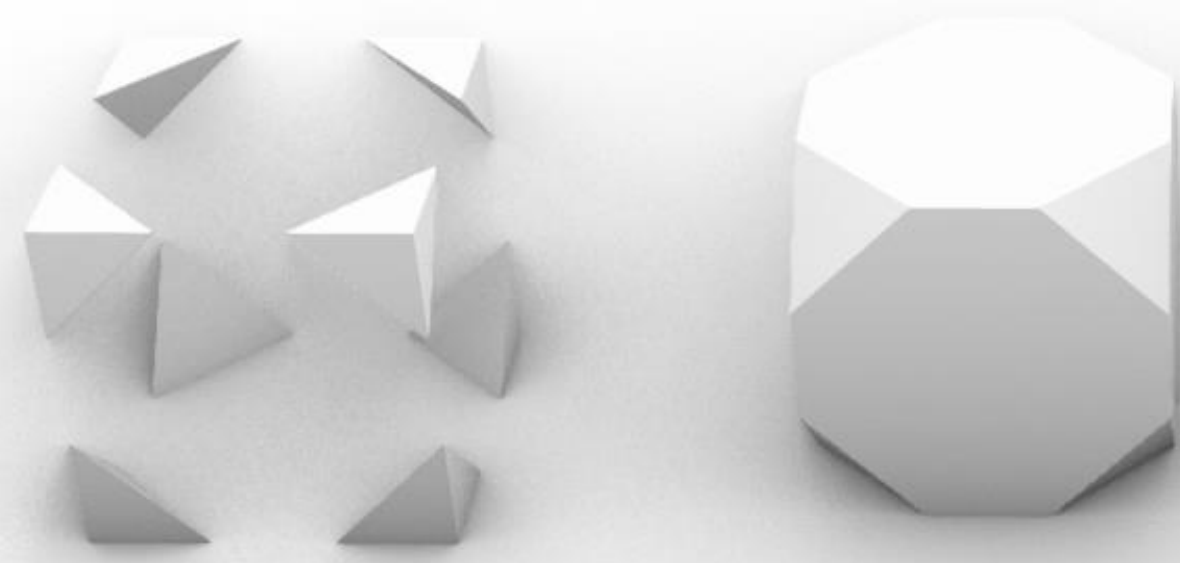

Cubo Truncado a 1/3 da aresta

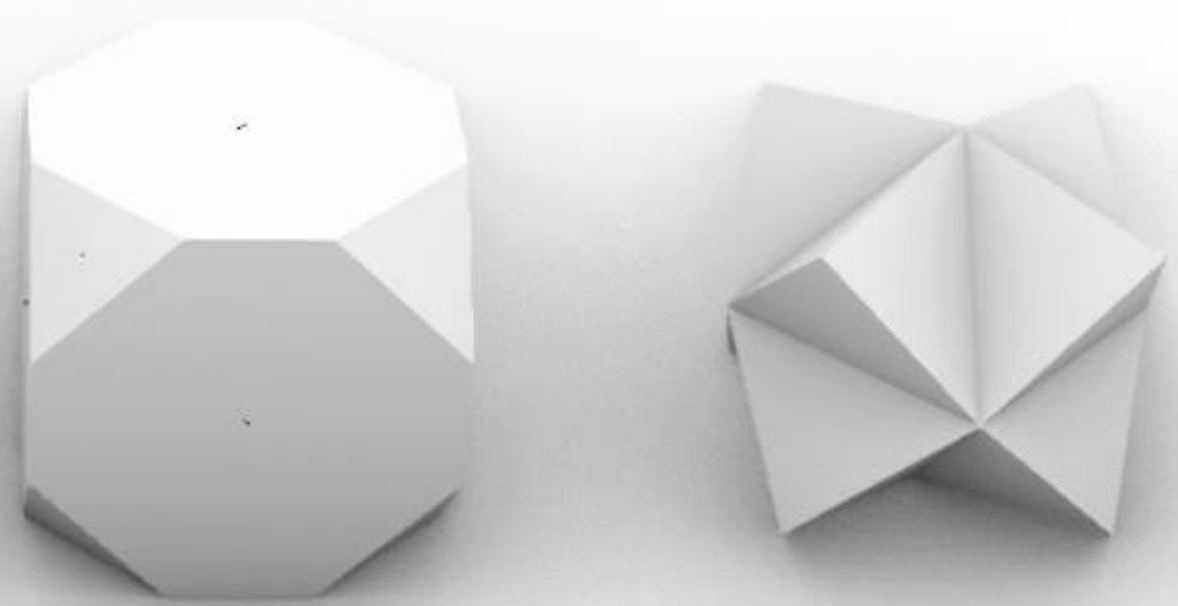

Dual do Cubo Truncado

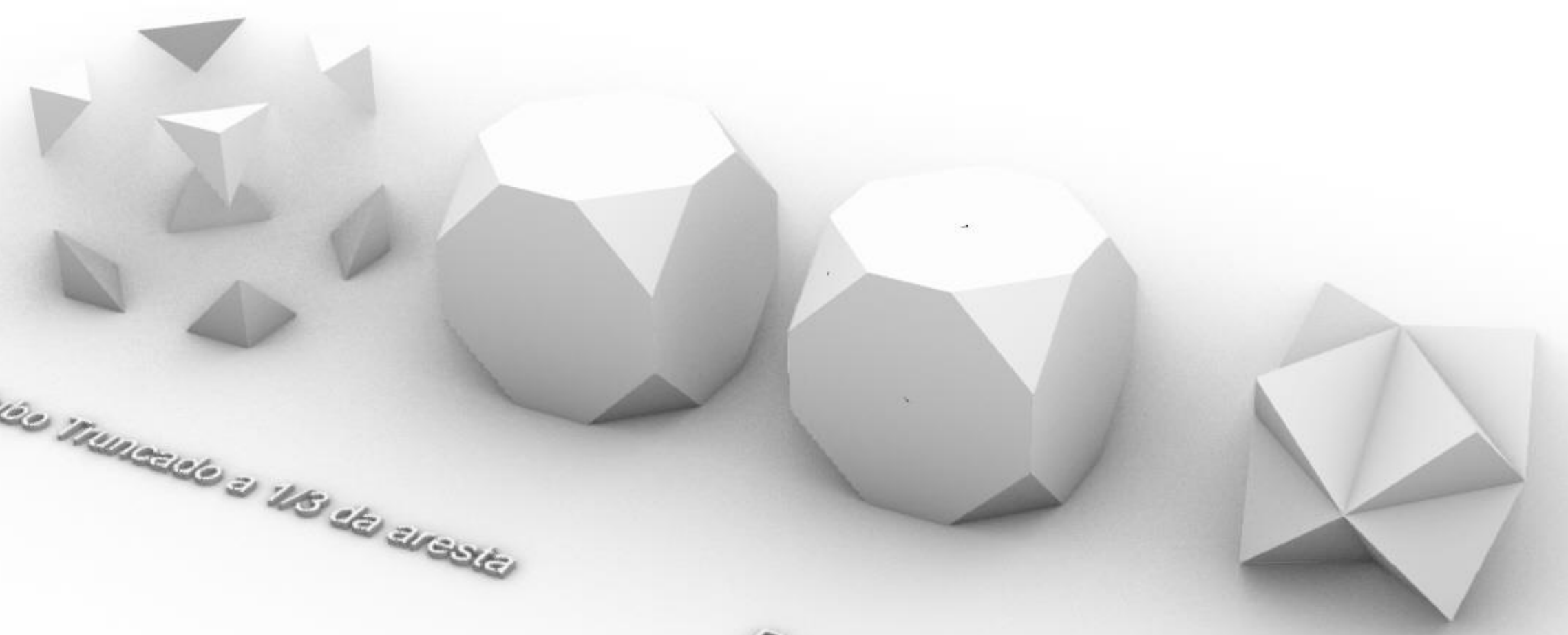

Cubo Truncado a 1/3 da aresta

Dual do Cubo Truncado

Exerc. 2.1 - Cubo

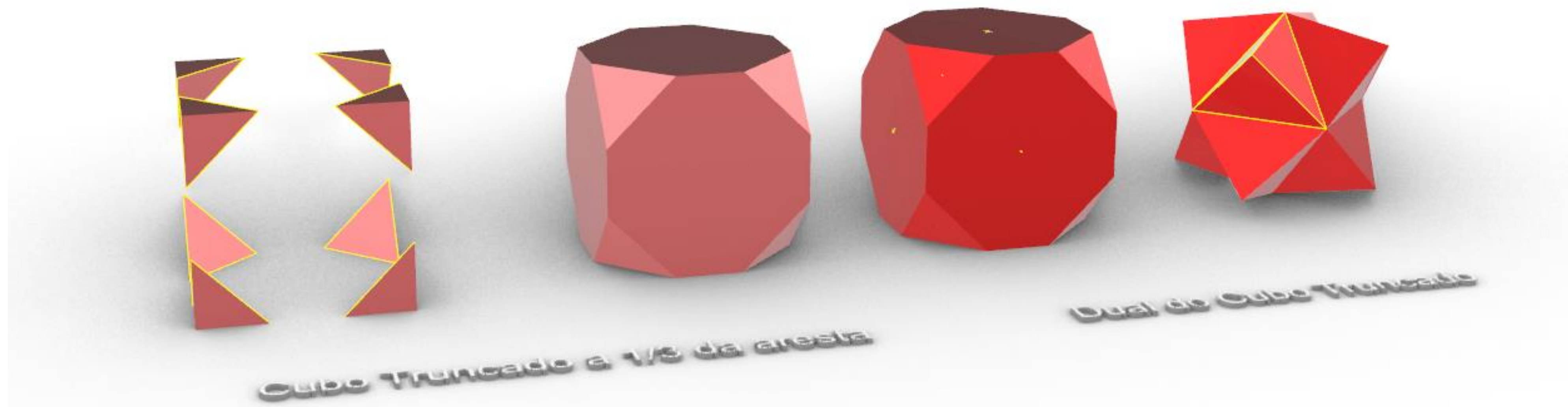

Exerc. 2.1 - Cubo

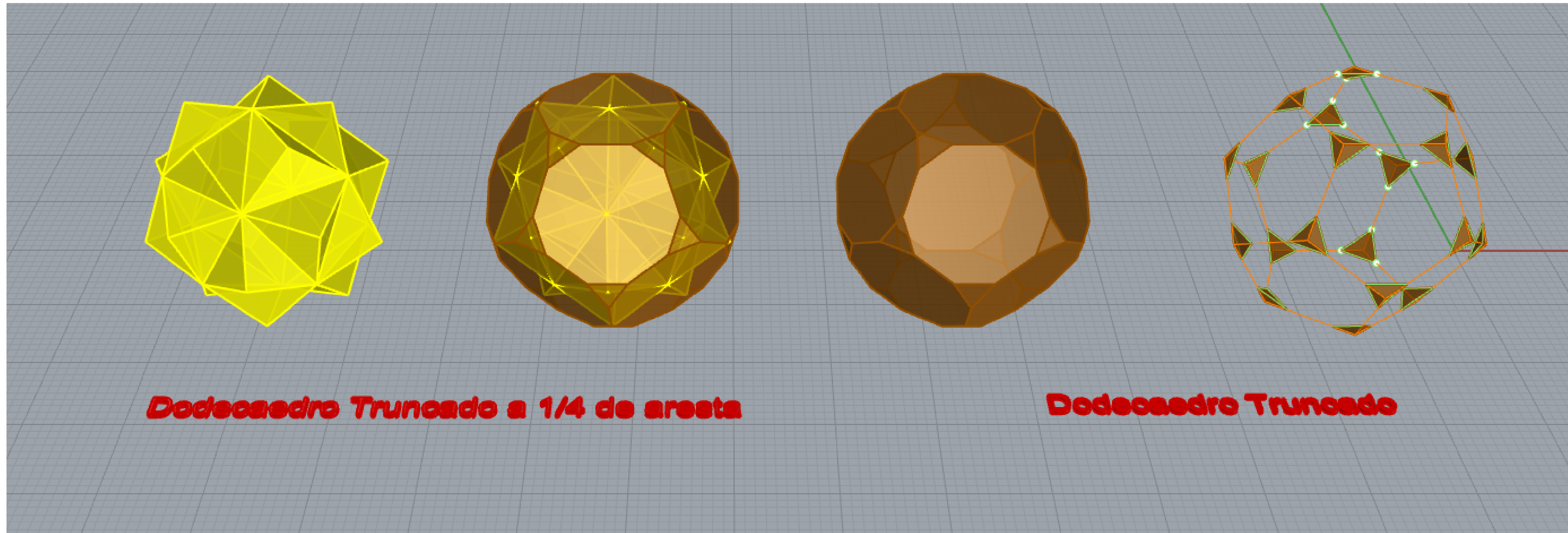

Exerc. 2.2 – Dodecaedro (Processo)

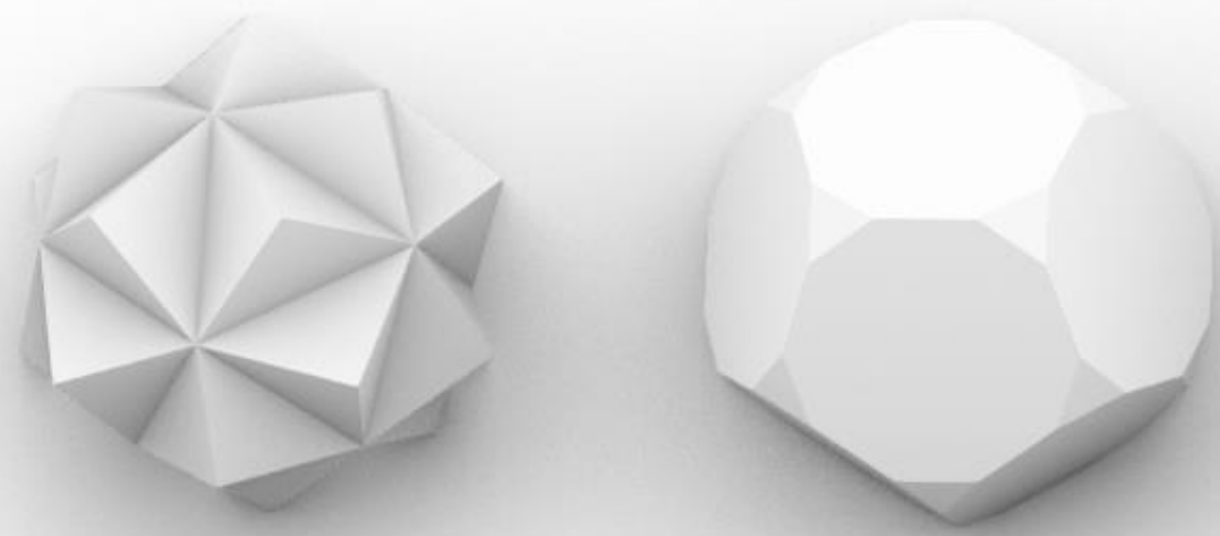

Dodecaedro Truncado a 1/4 de aresta

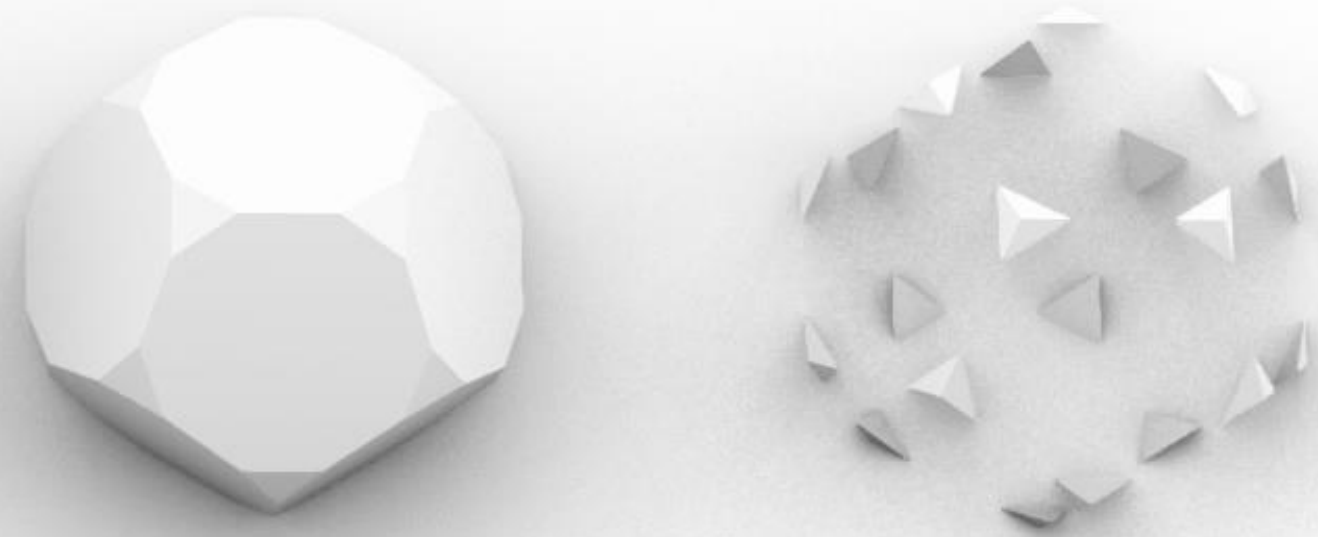

Dodecaedro Truncado

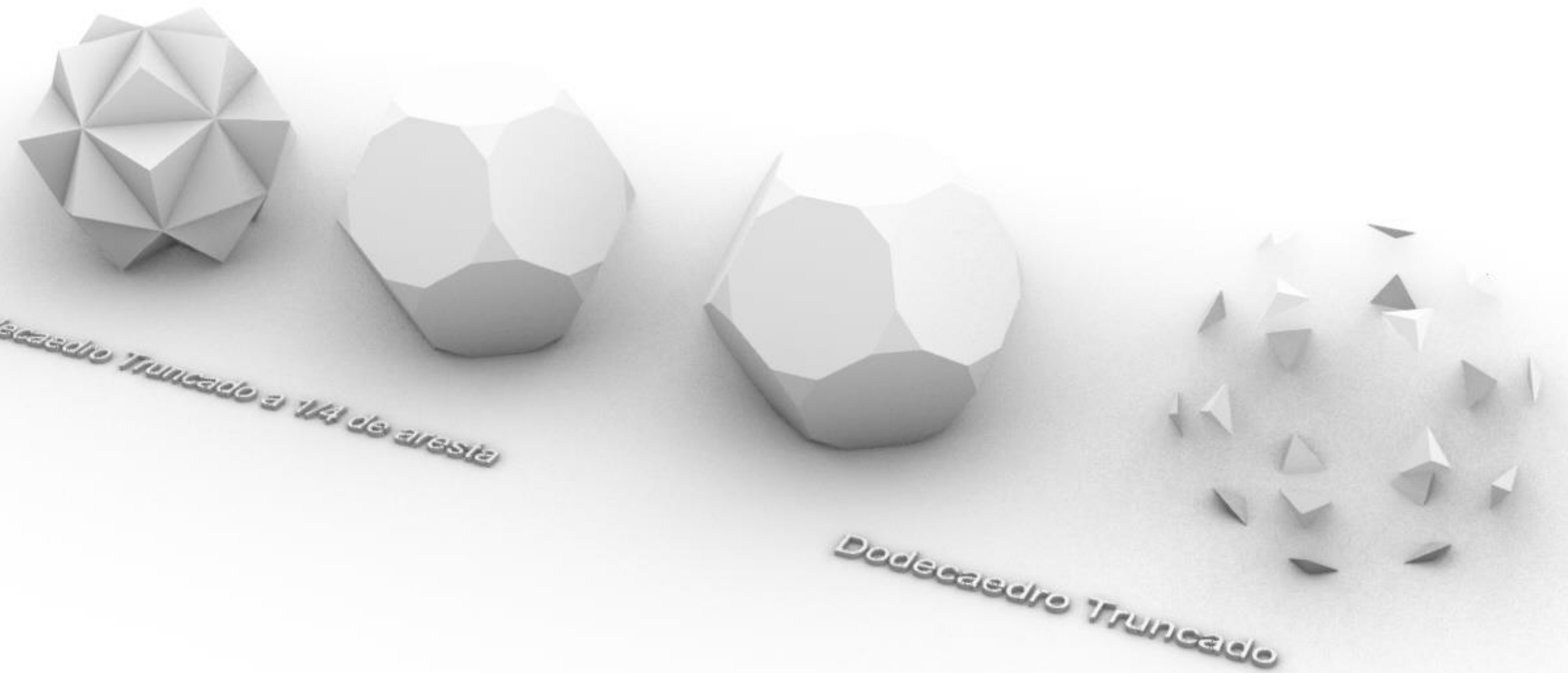

Dodecaedro Truncado a 1/4 de aresta

Dodecaedro Truncado

Exerc. 2.2 - Dodecaedro

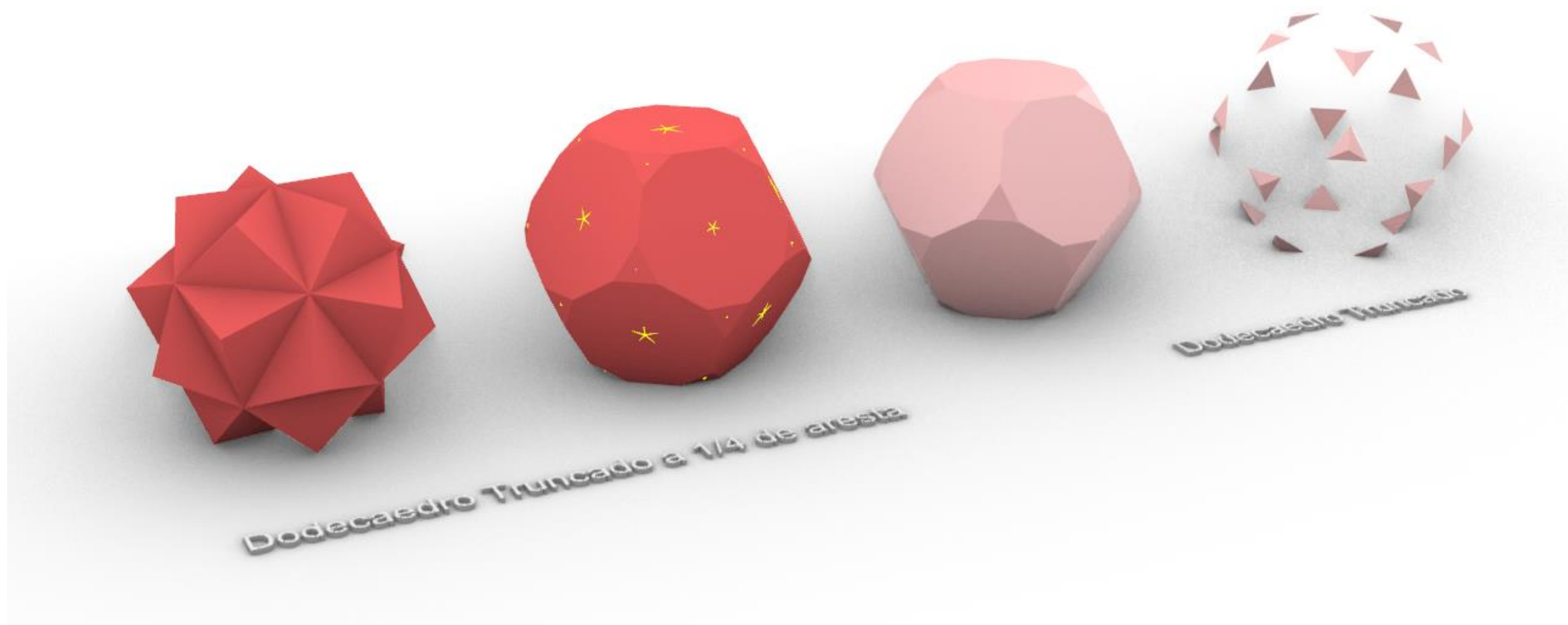

Exerc. 2.2 - Dodecaedro

Exerc. 3 – GRASSHOPPER

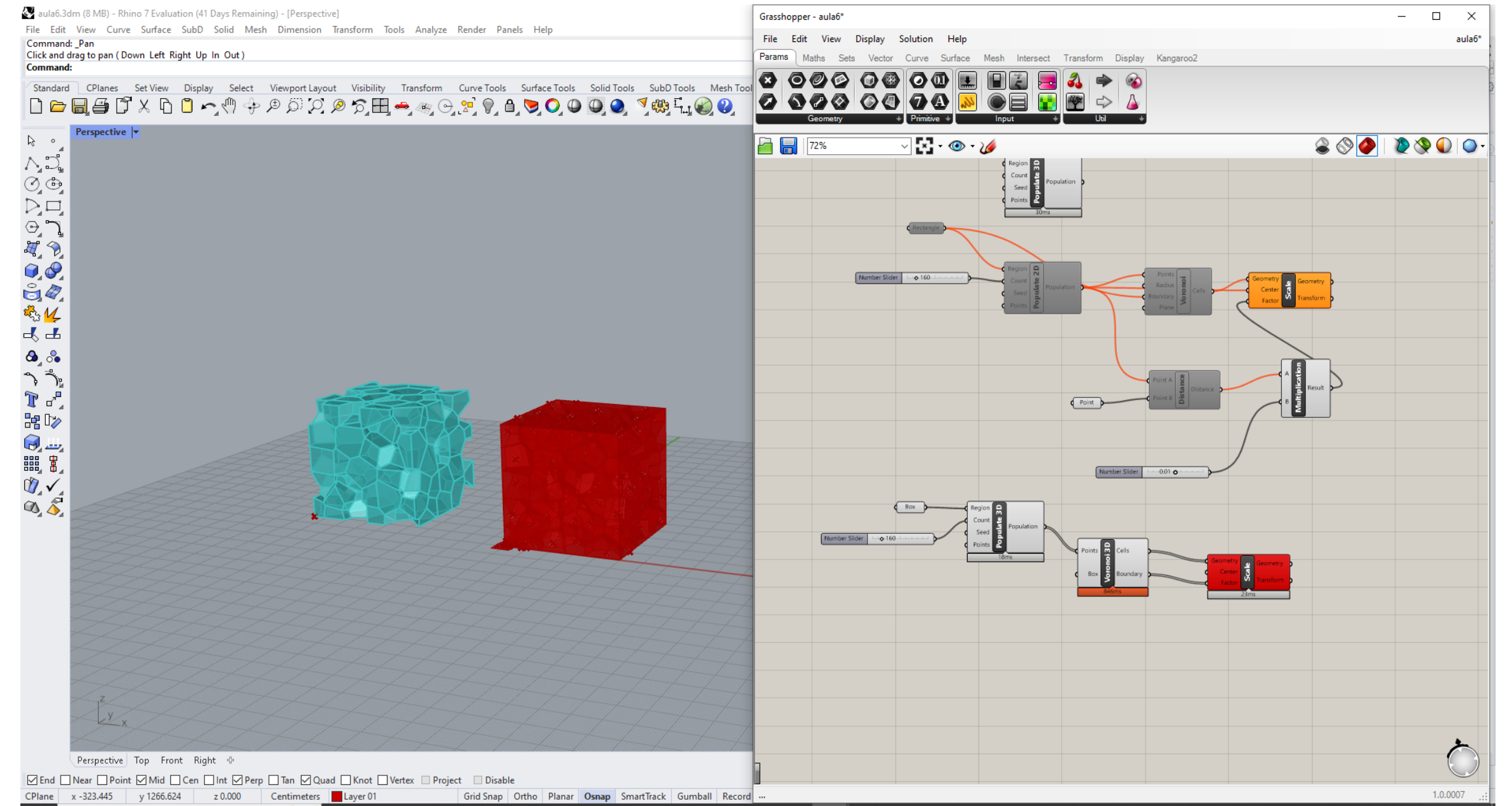
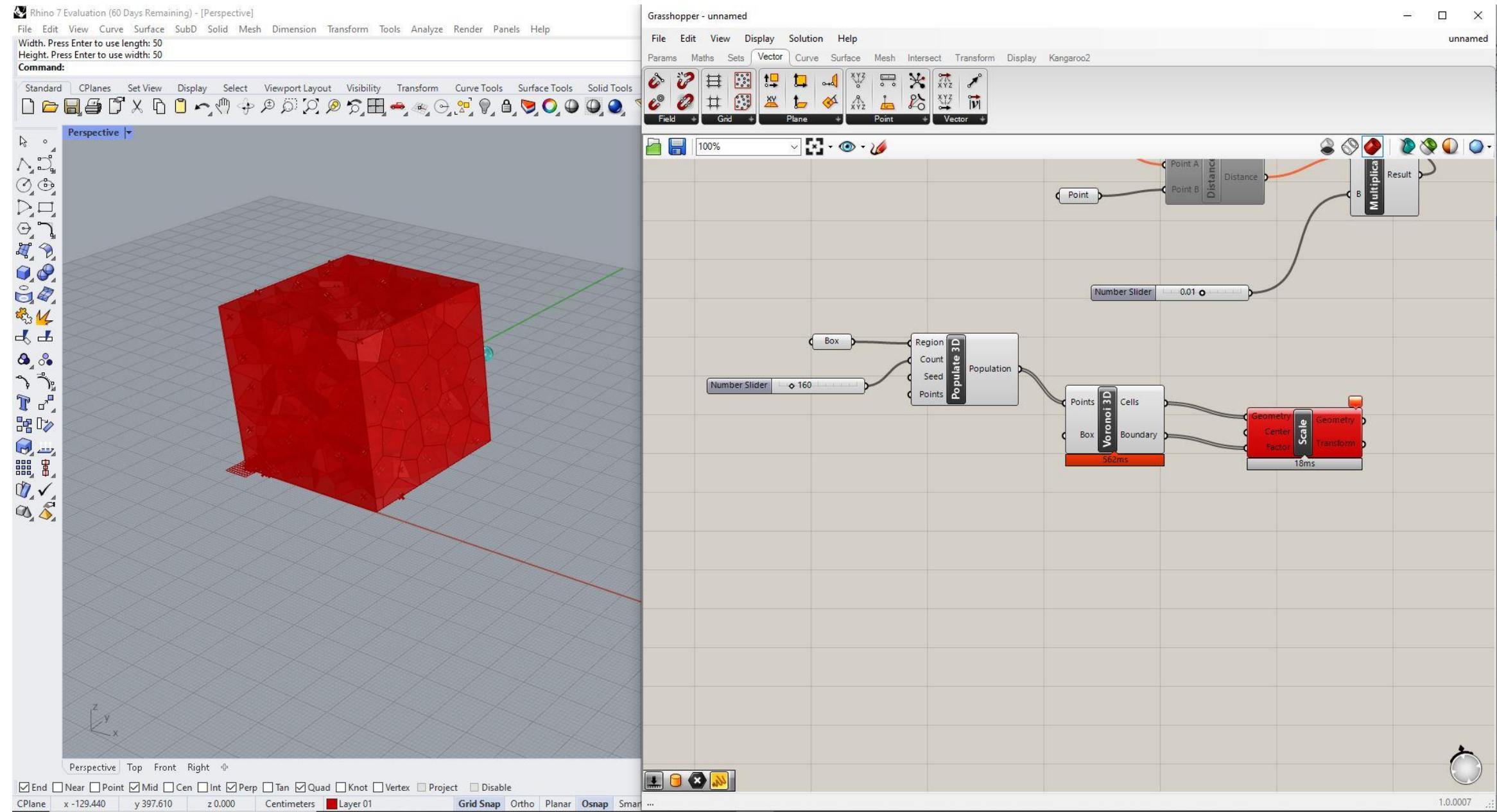

Exerc. 3.1 – Grasshopper Cubo (Processo)

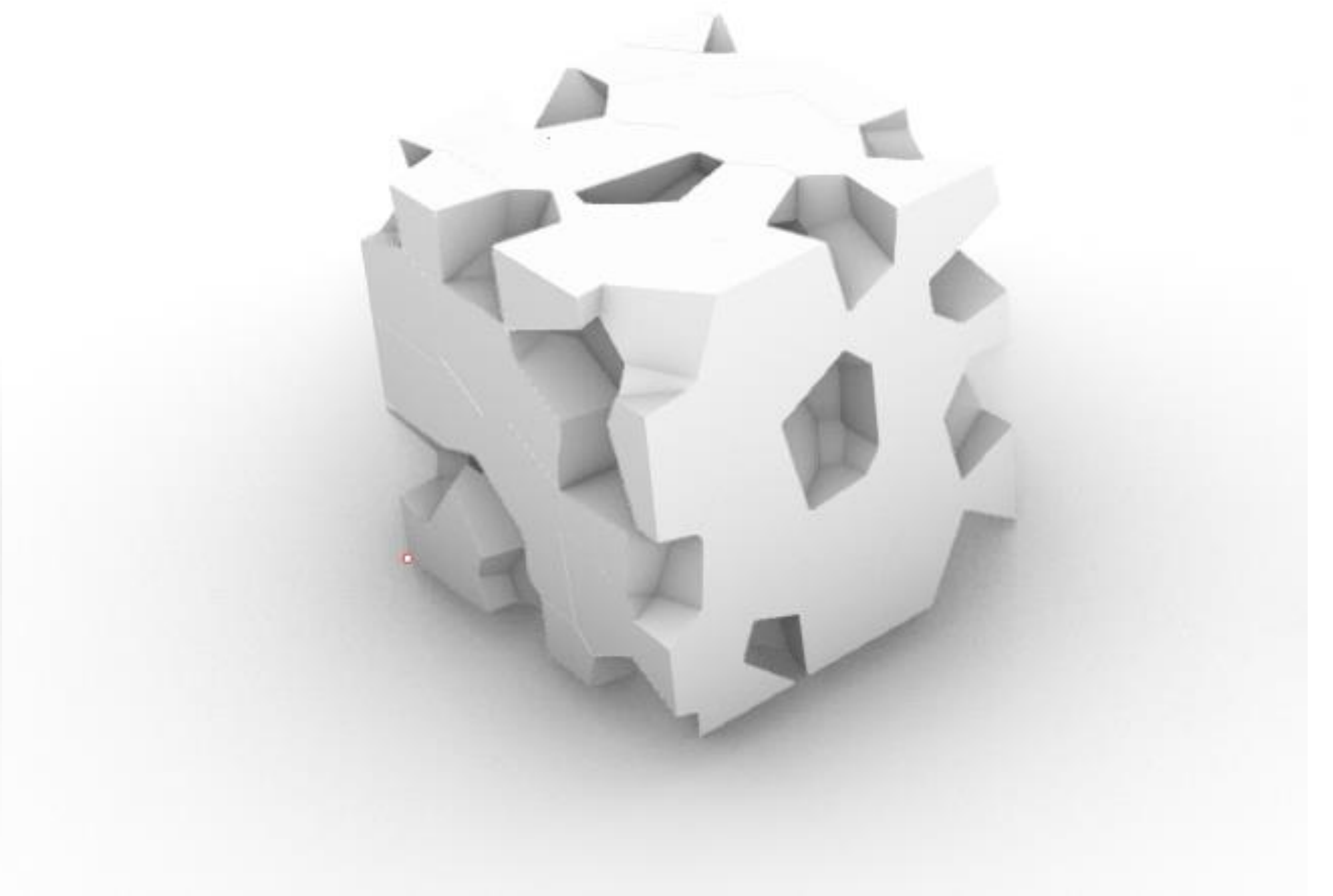
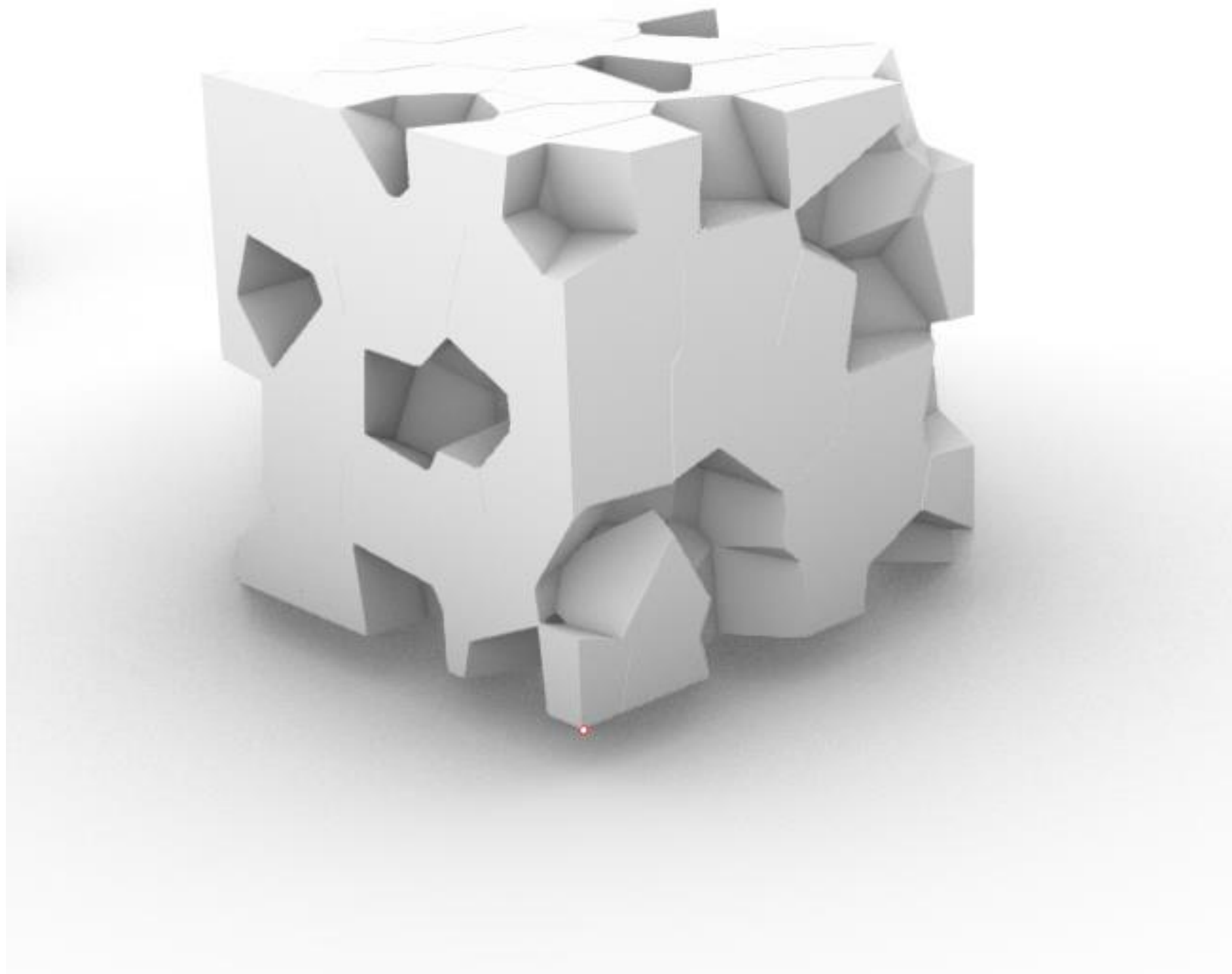

Exerc. 3.1 – Grasshopper Cubo

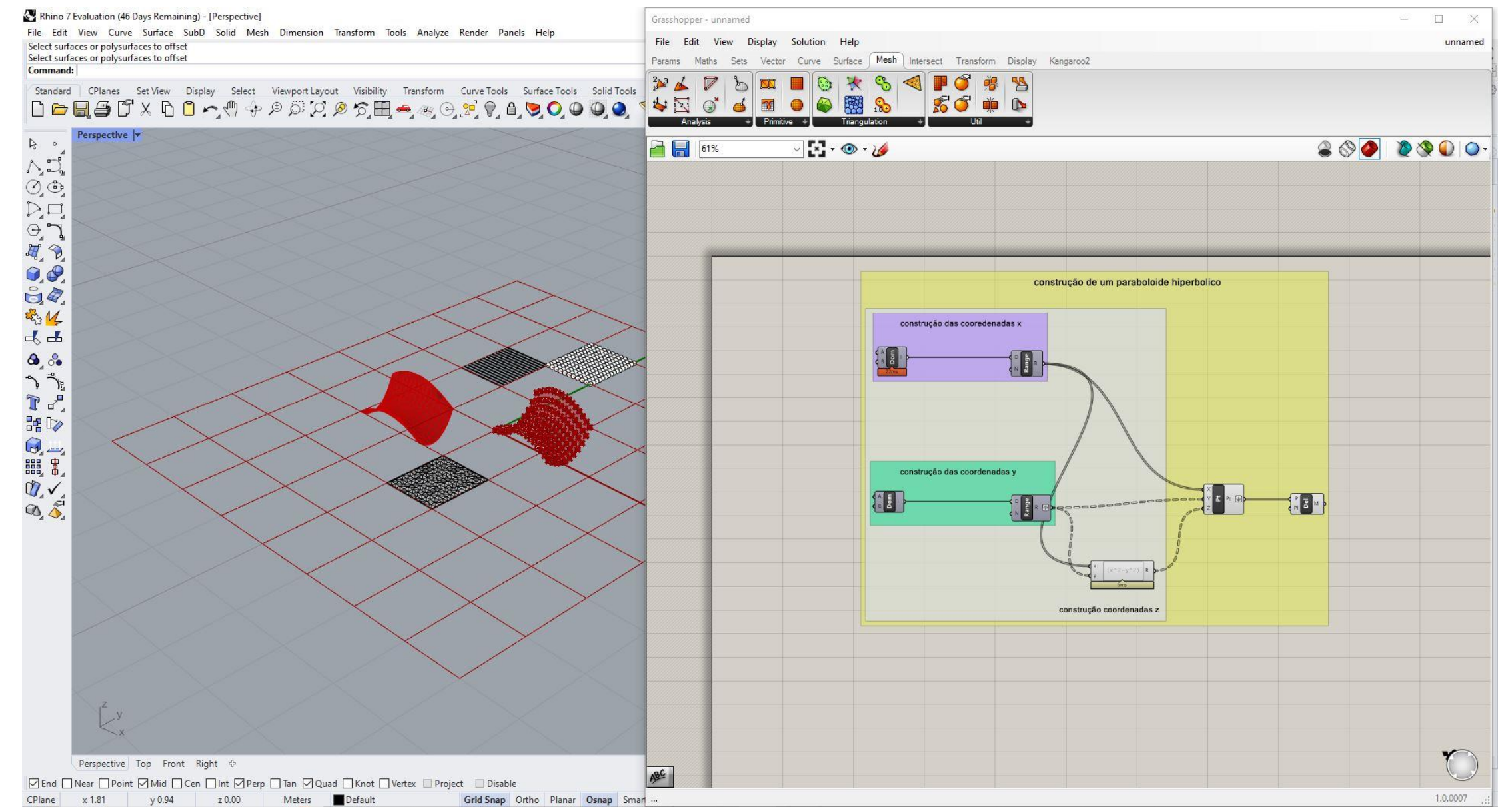
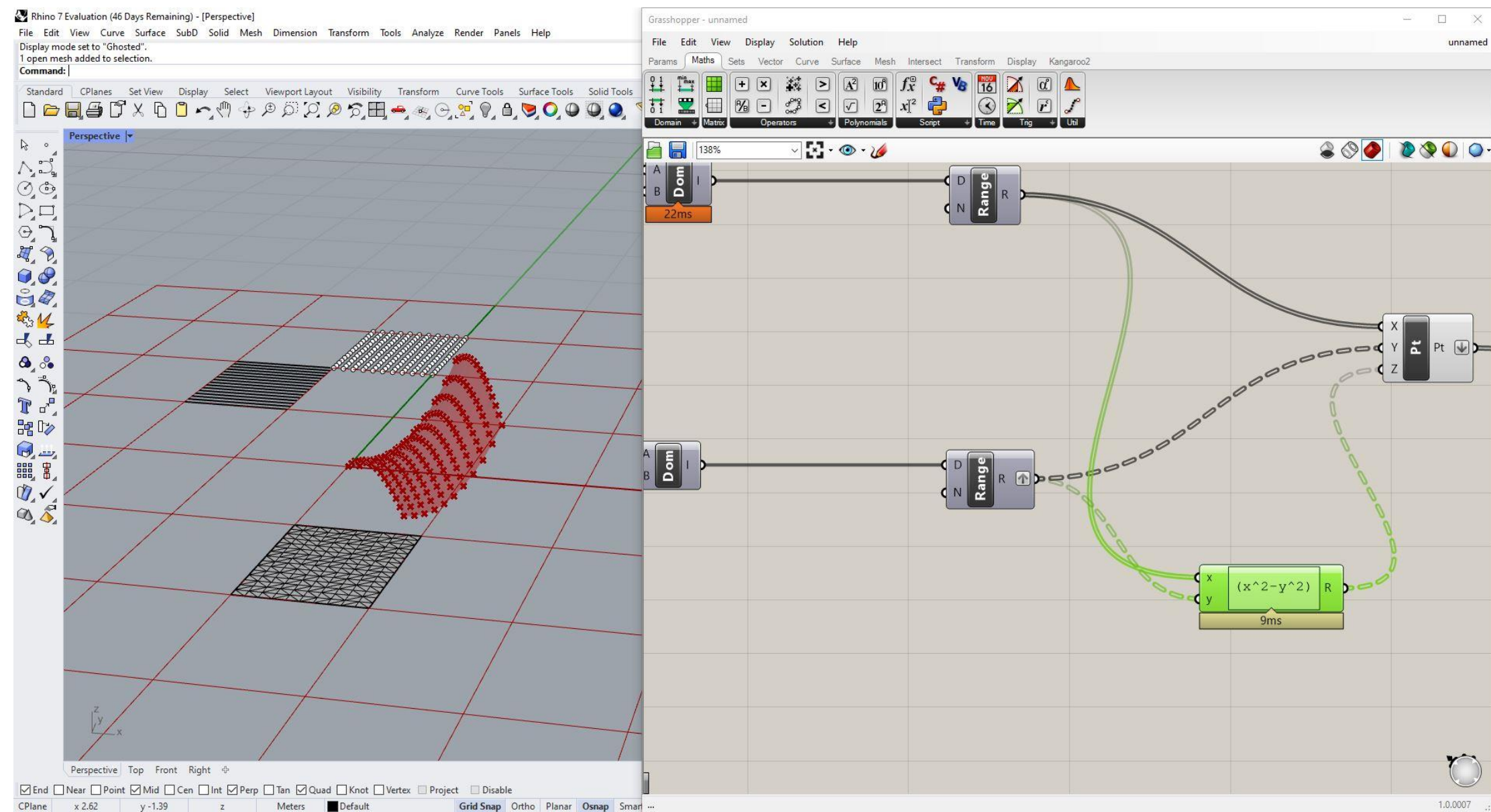

Exerc. 3.2 – Grasshopper Parabolóide (Processo)

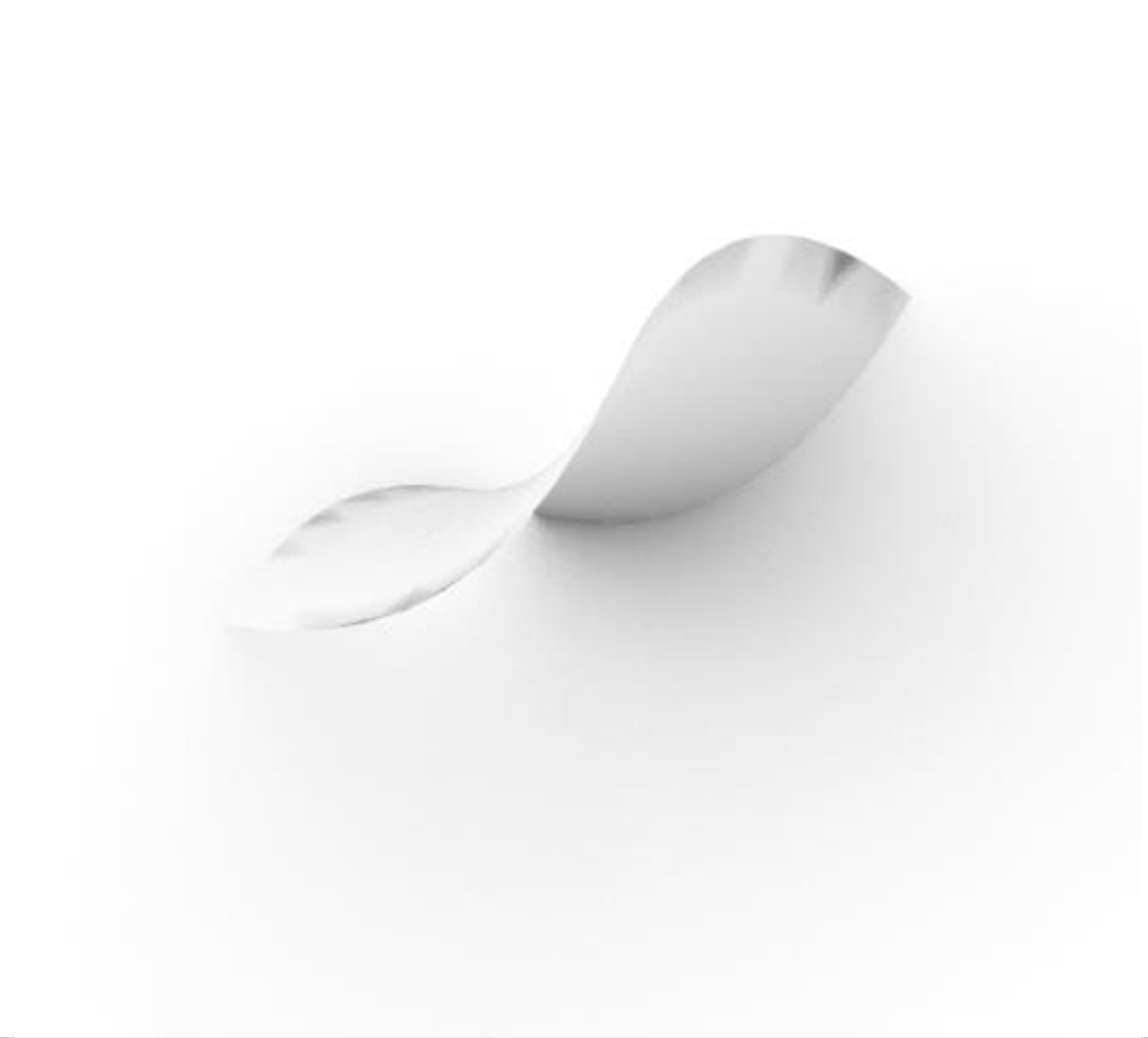
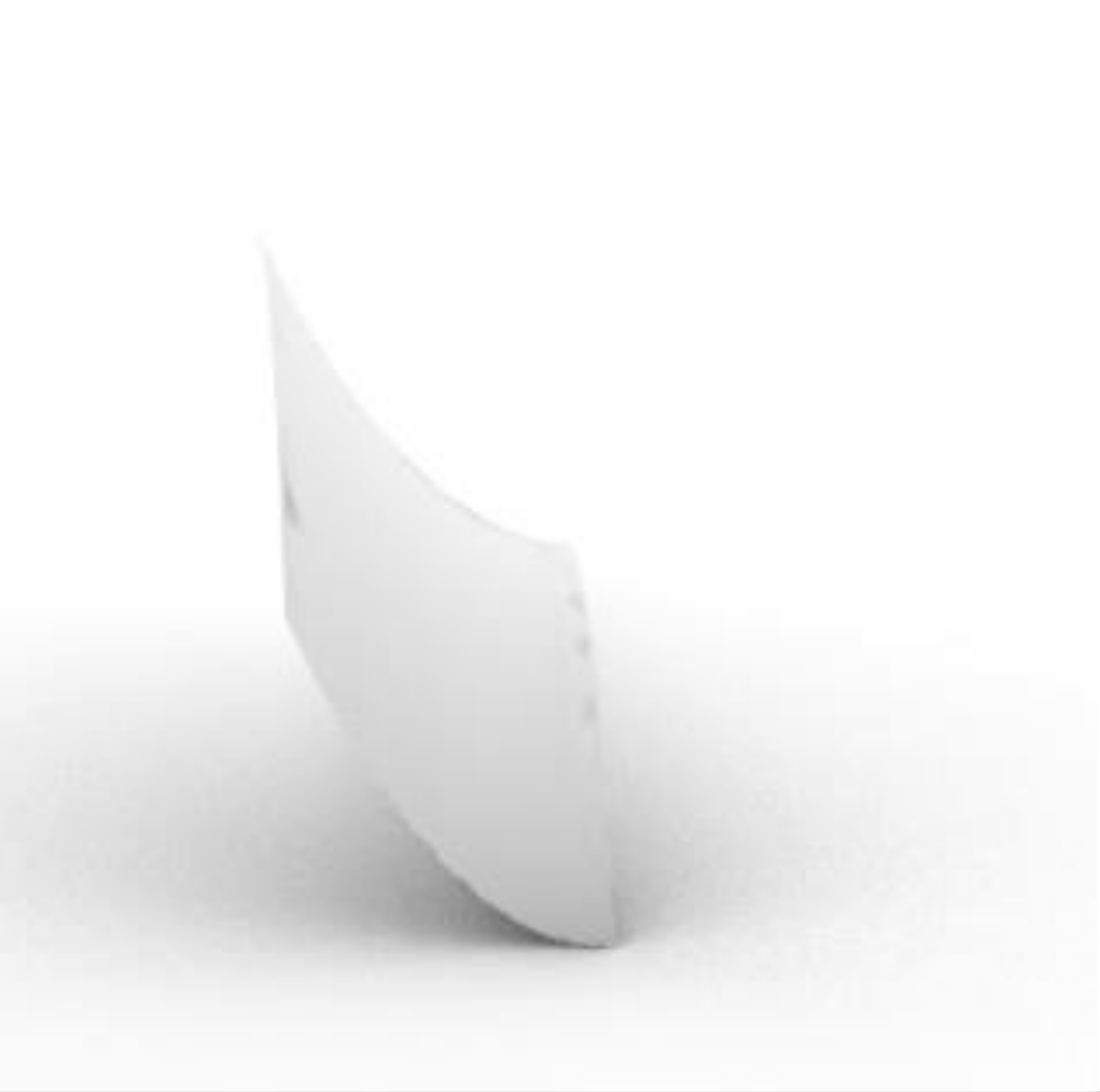

Exerc. 3.2 – Grasshopper Paraboloidoide

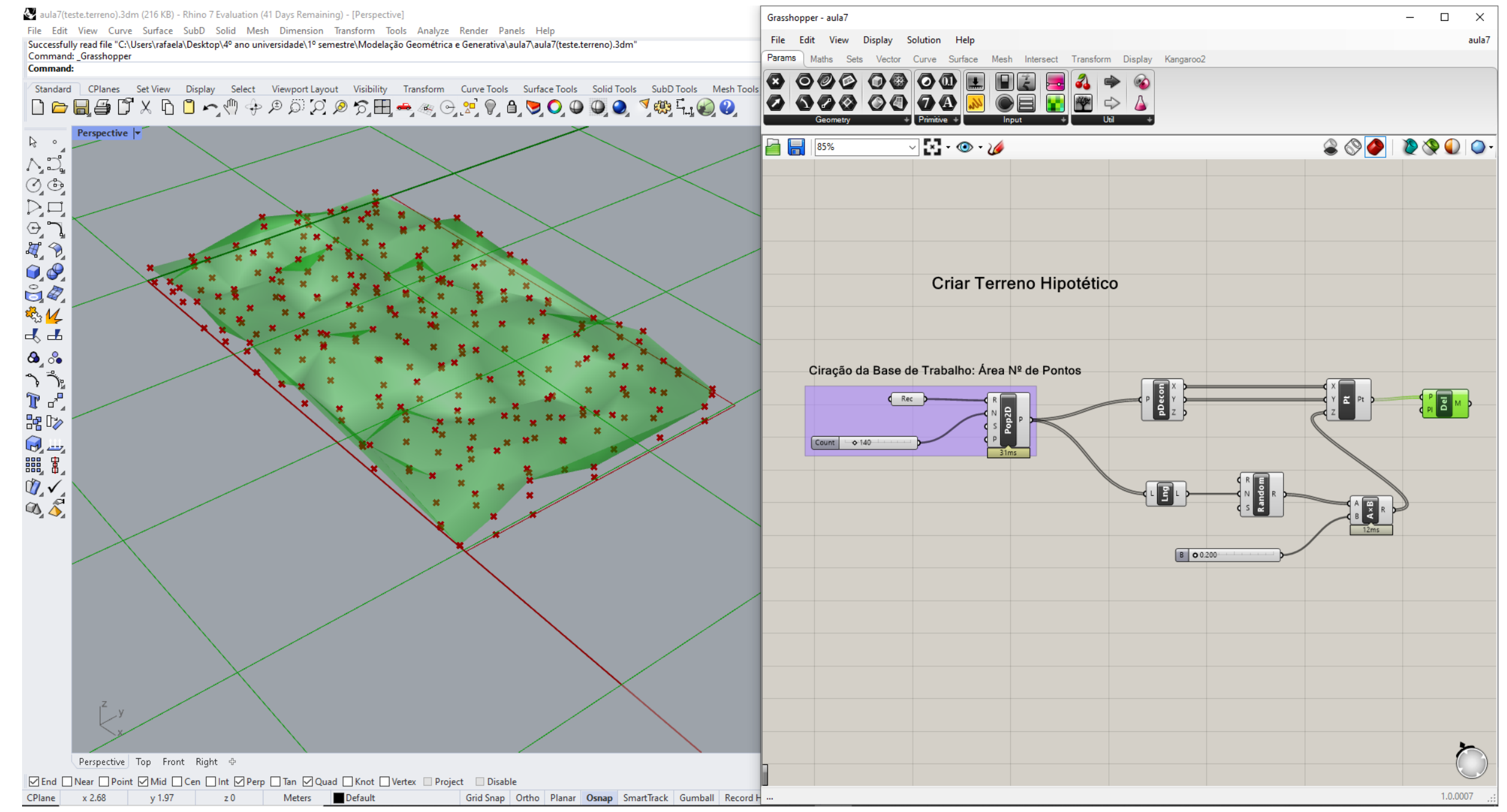
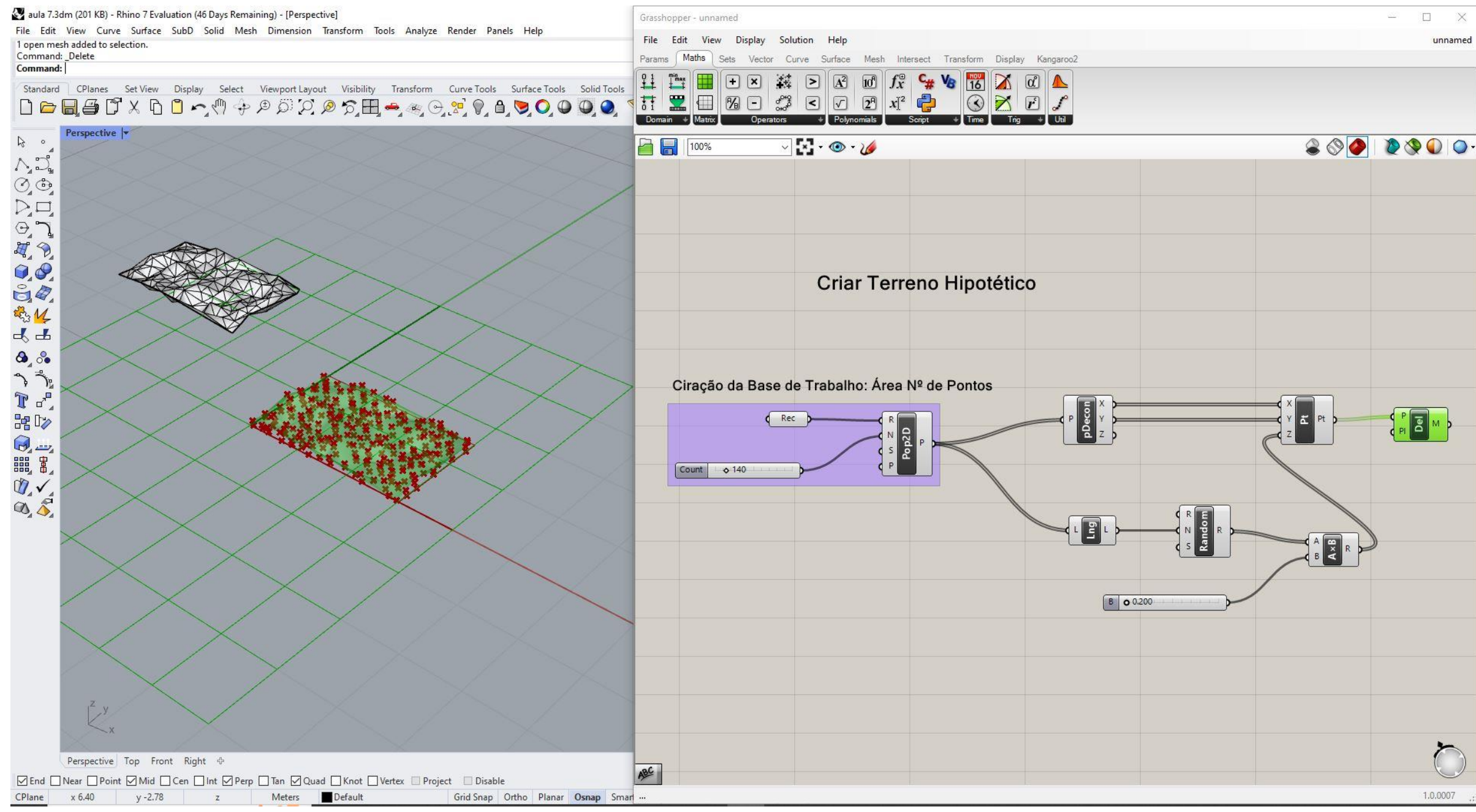

Exerc. 3.3 – Grasshopper Terreno (Processo)

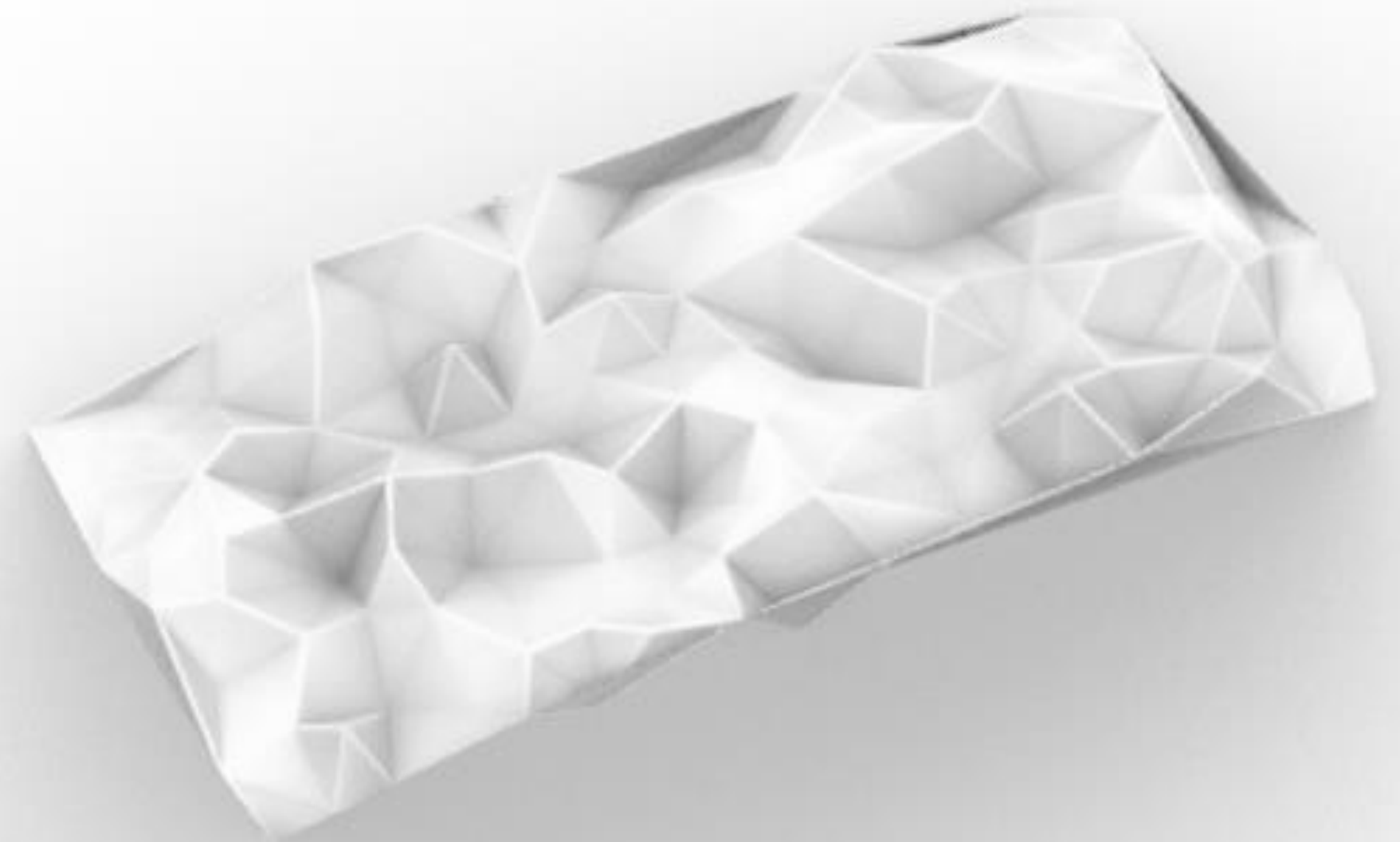
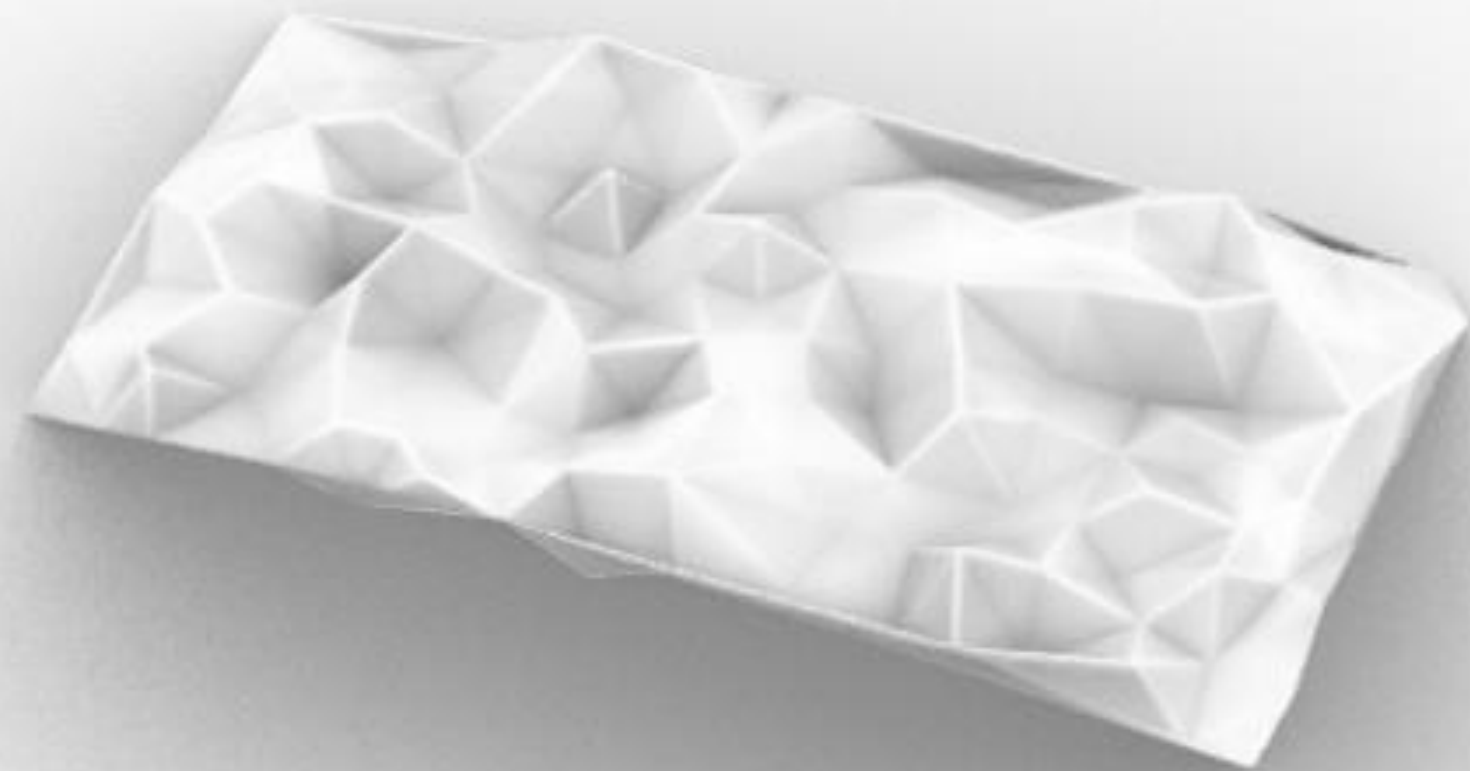

Exerc. 3.3 – Grasshopper Terreno



Exerc. 3.4 – Grasshopper Terreno Projeto

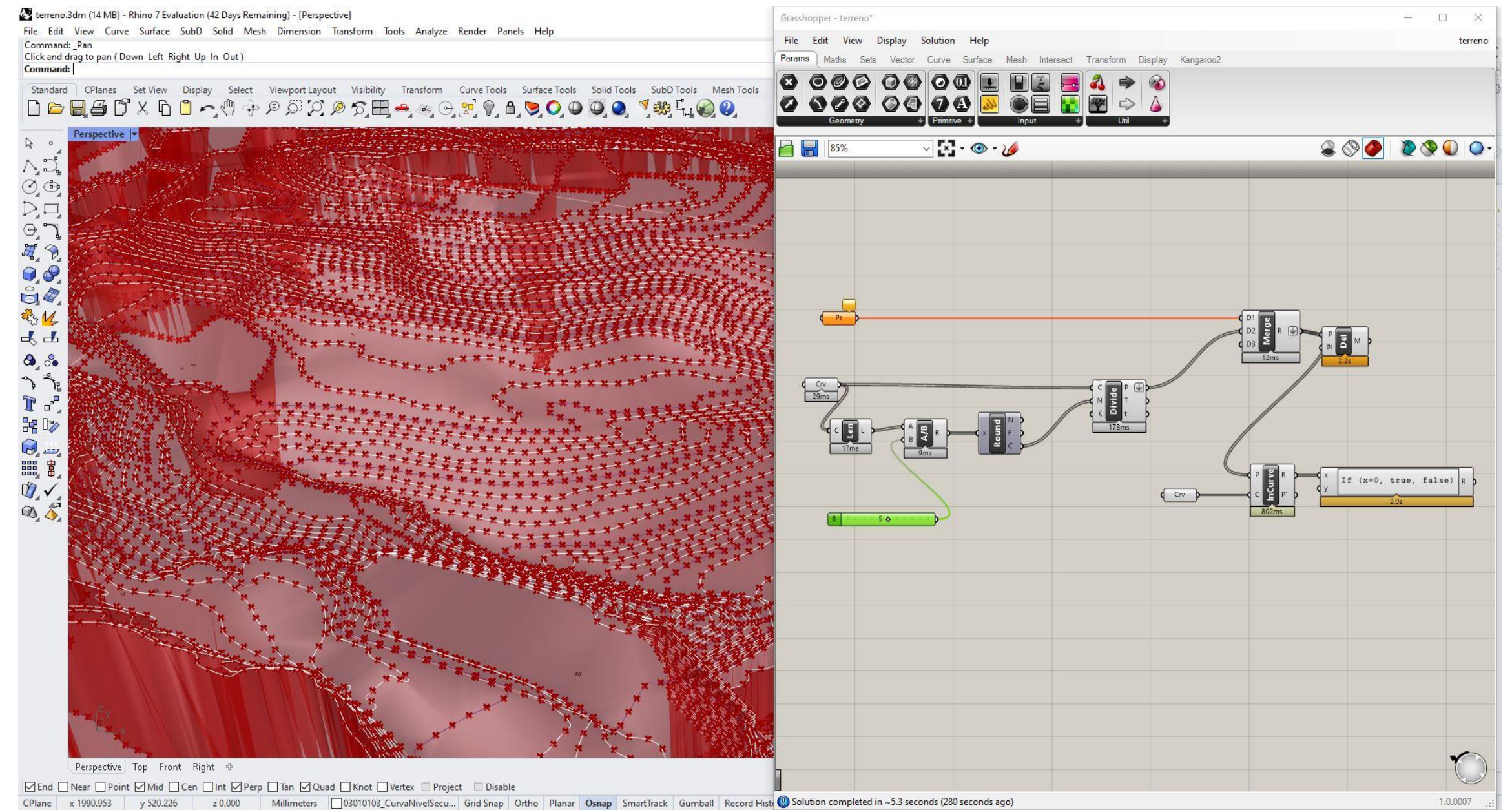
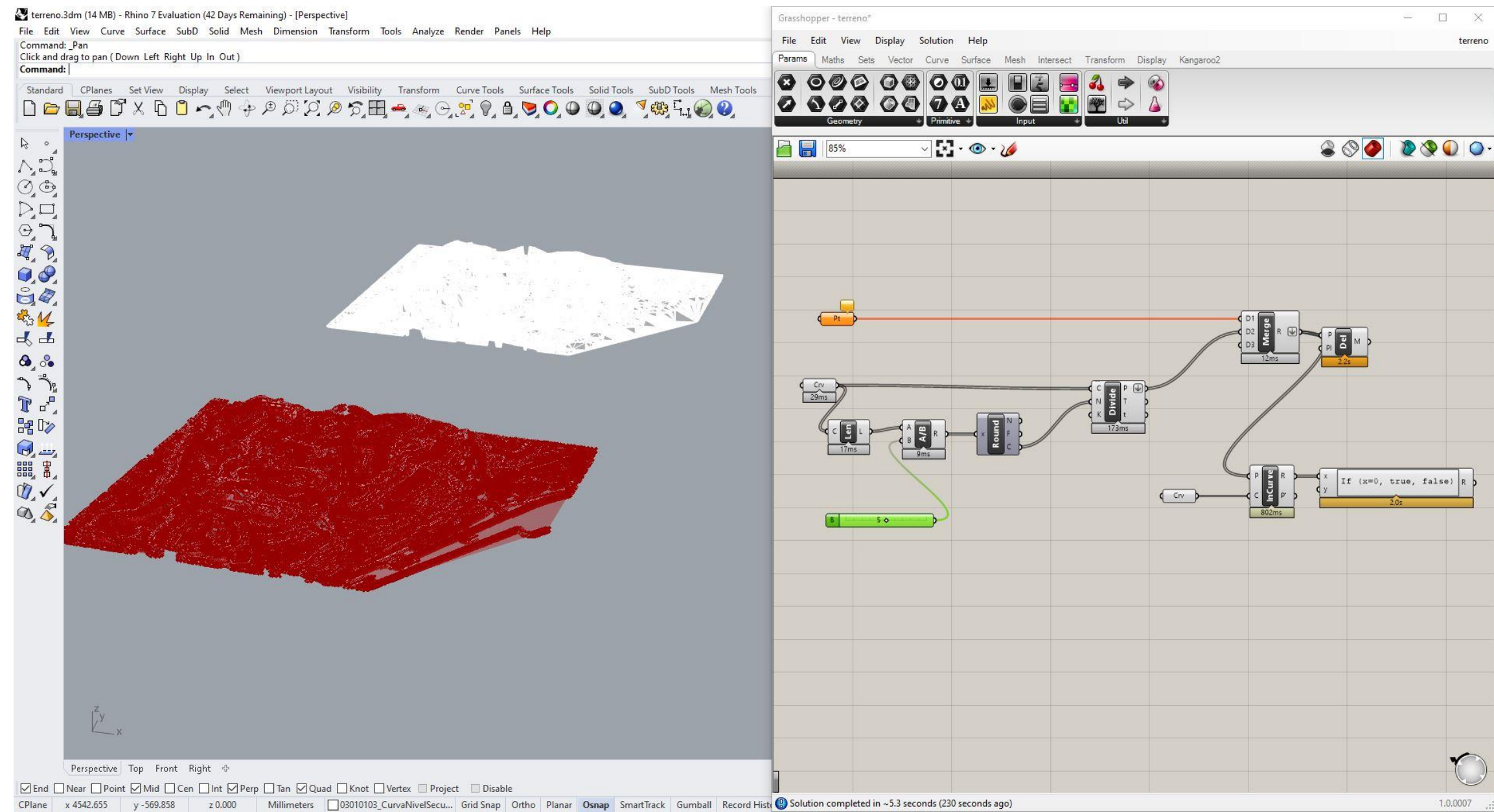

Exerc. 3.4 – Grasshopper Terreno (Processo)

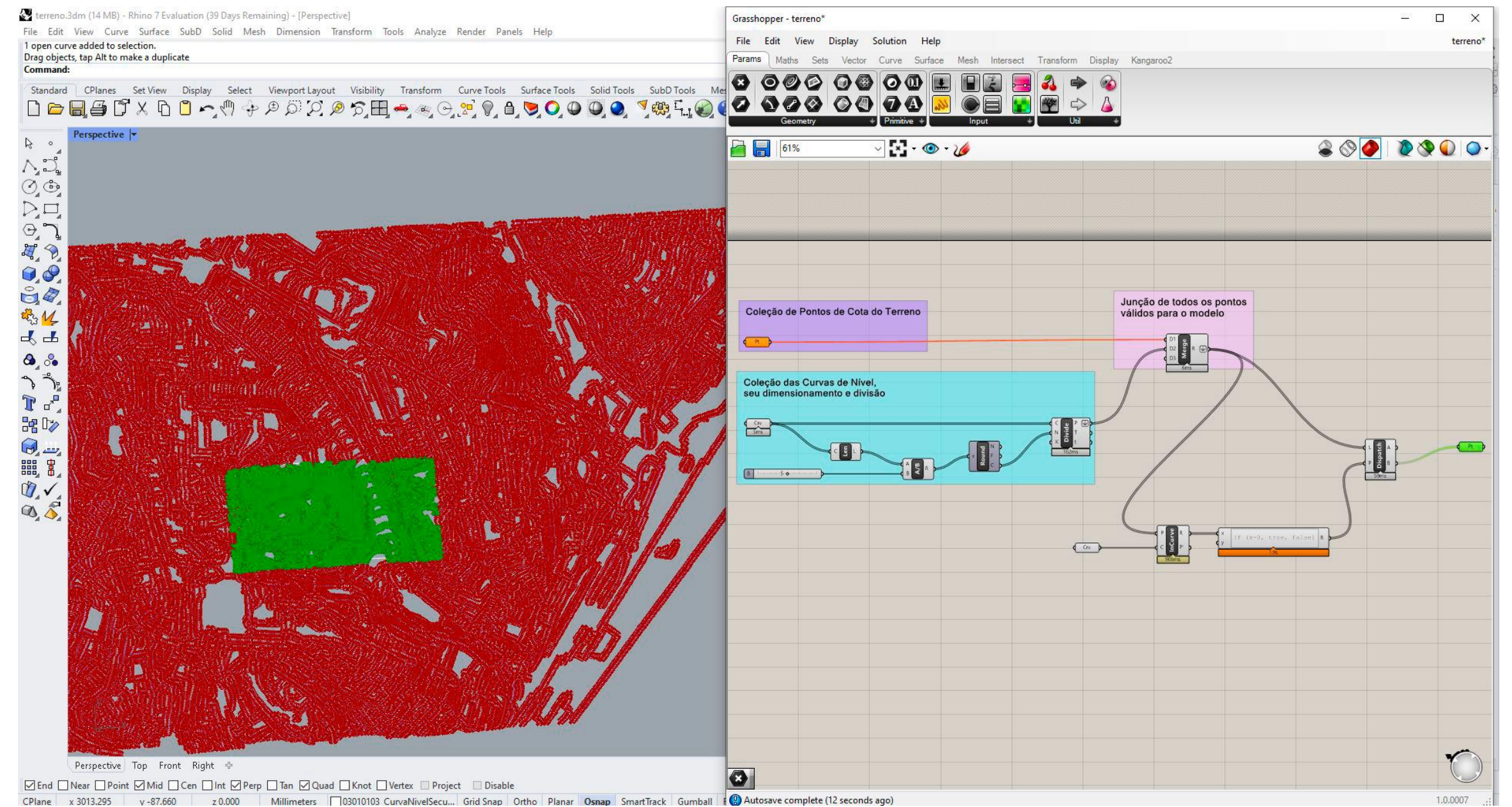
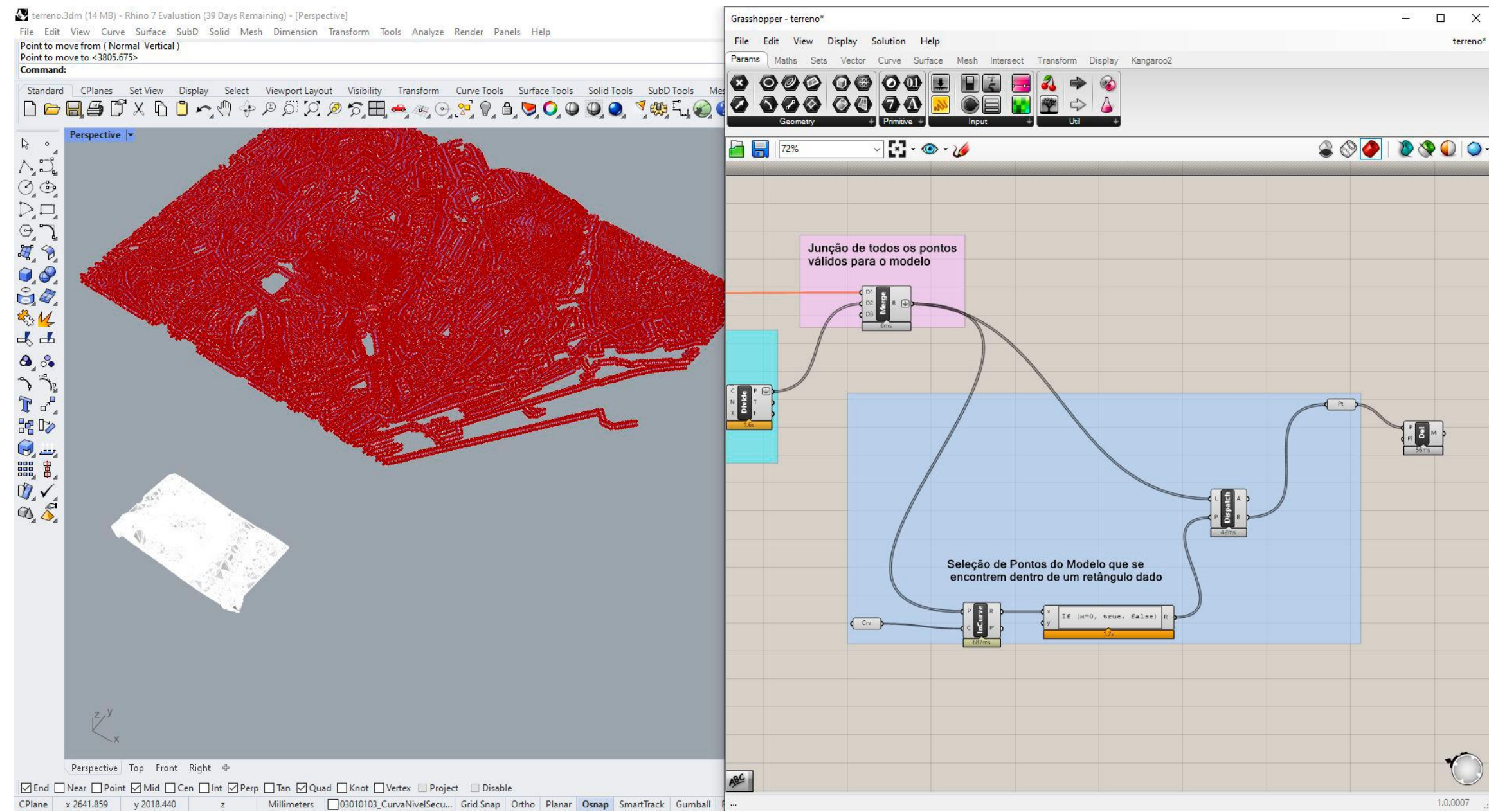

Exerc. 3.4 – Grasshopper Terreno (Processo)

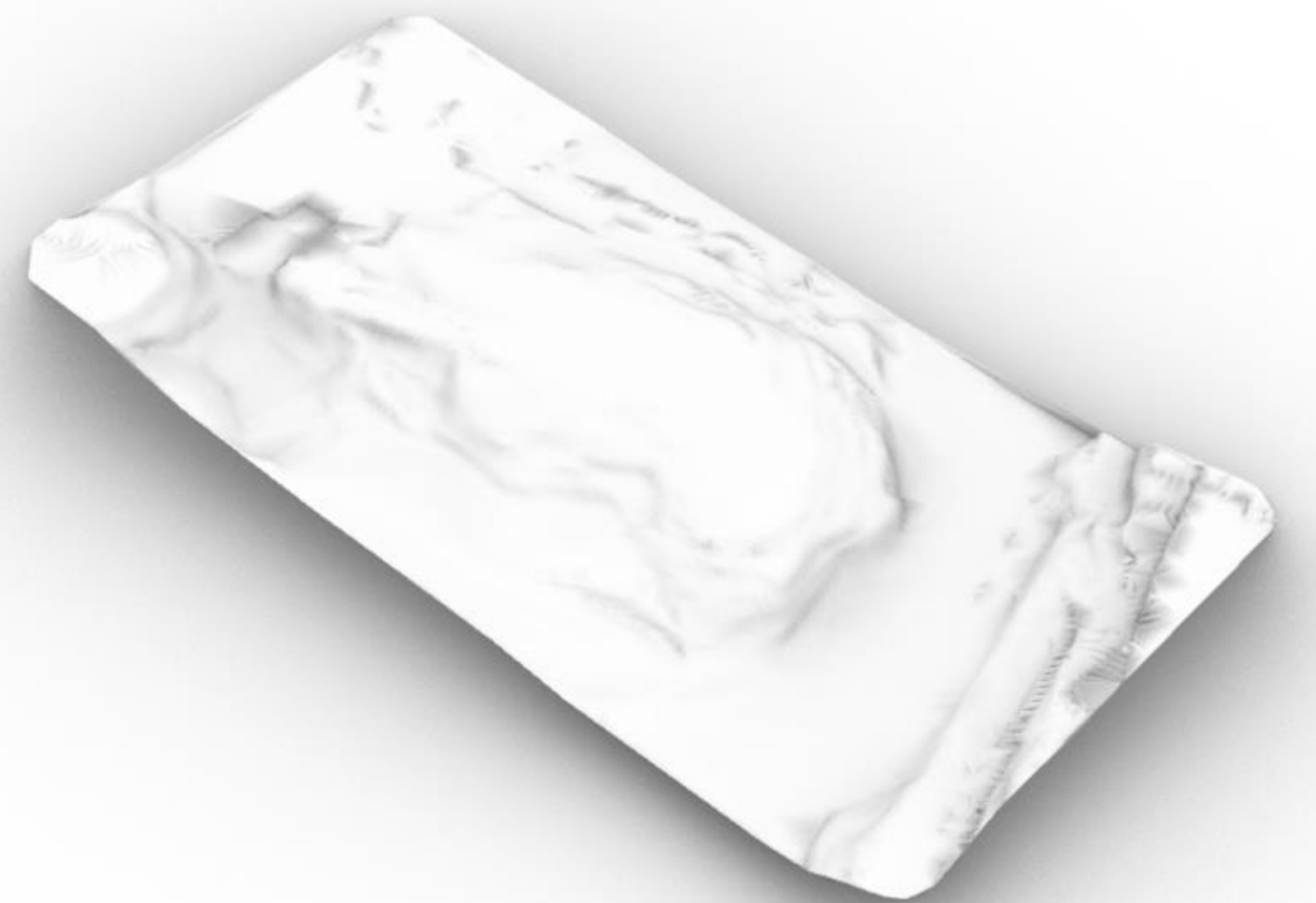
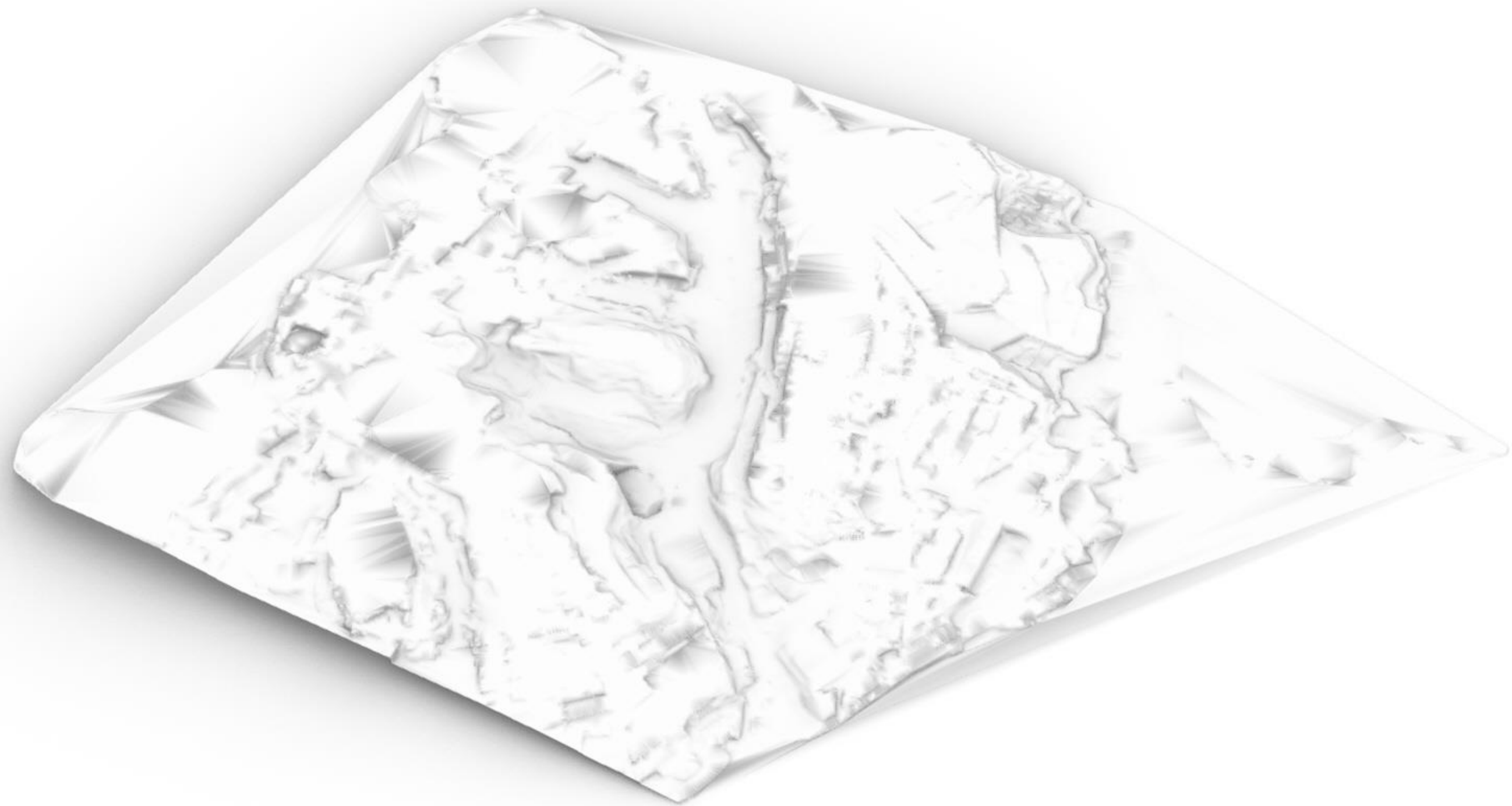

Exerc. 3.4 – Grasshopper Terreno Projeto



Exerc. 4 – CONCHAS GASTRÓPEDES



Exerc. 4.1 - Spirula

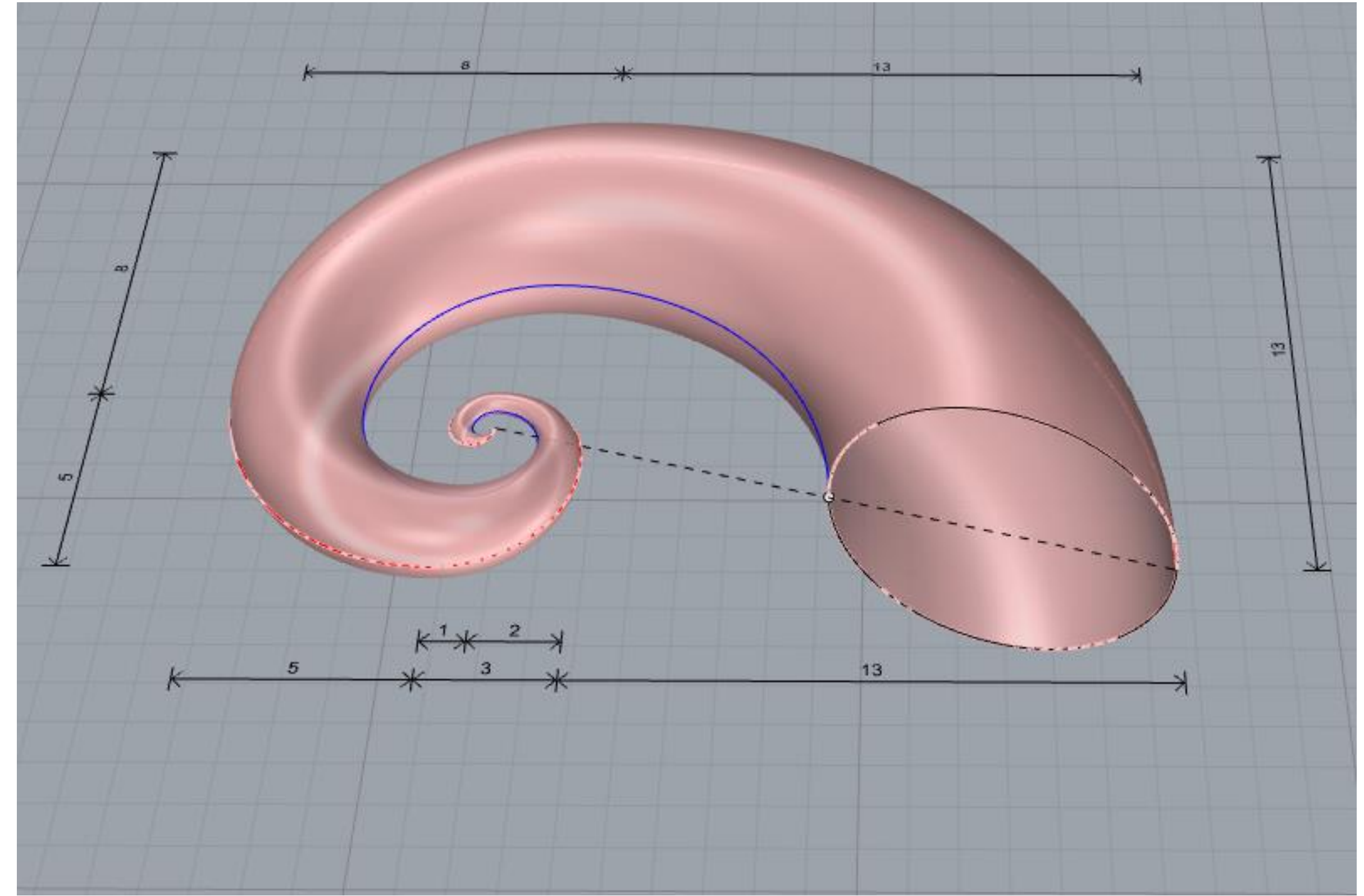
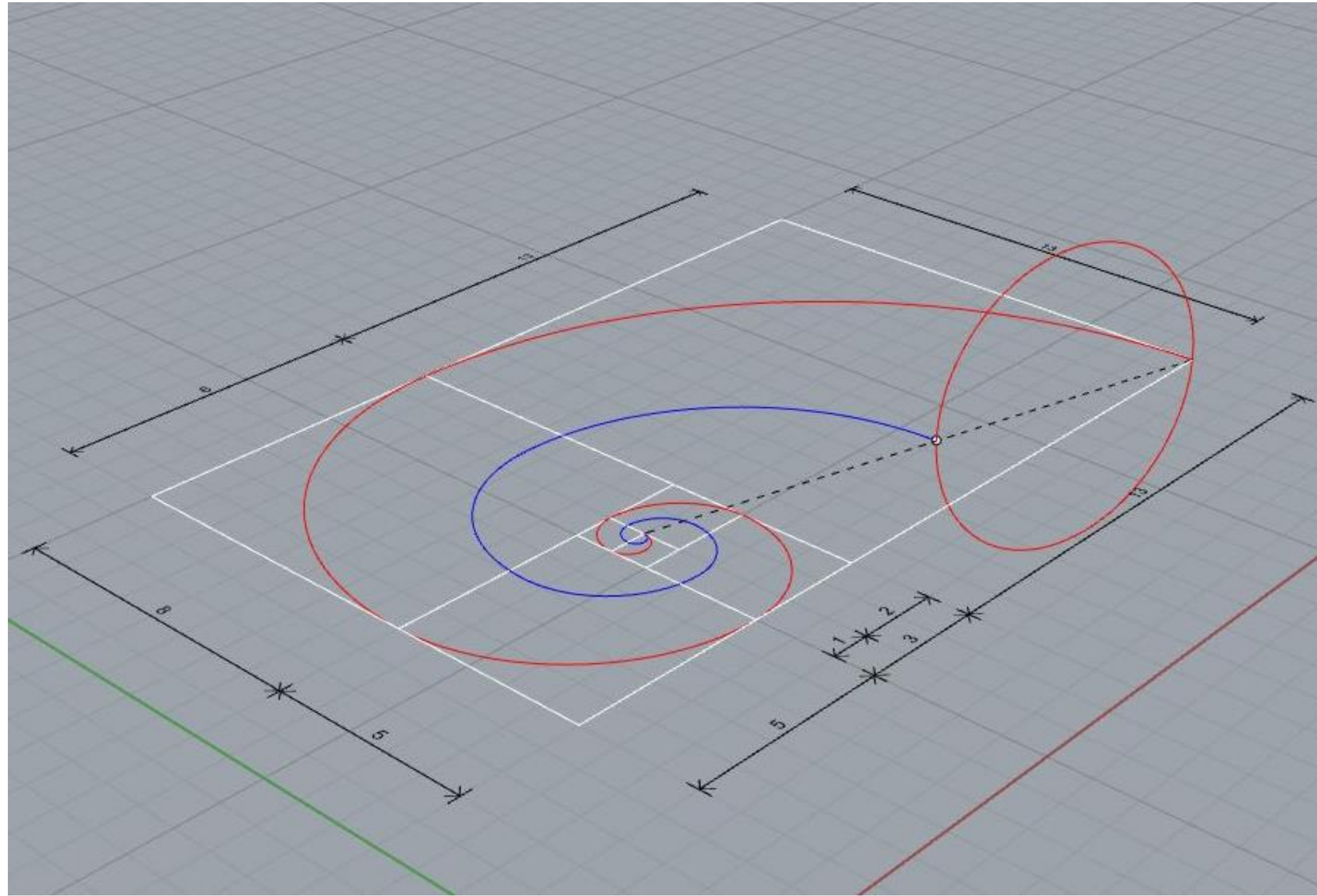

Exerc. 4.1 – Spirula (Processso)

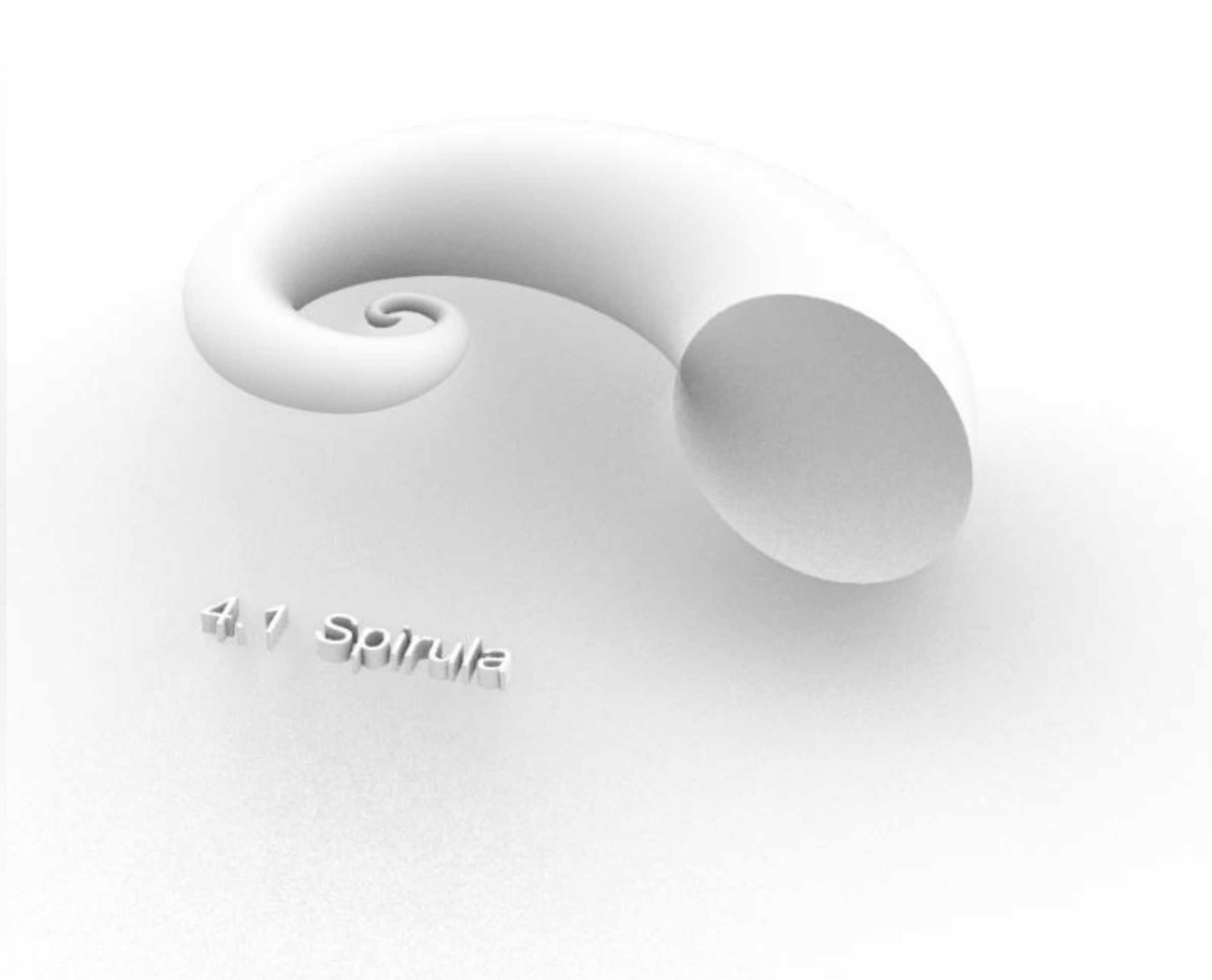

Exerc. 4.1 – Spirula

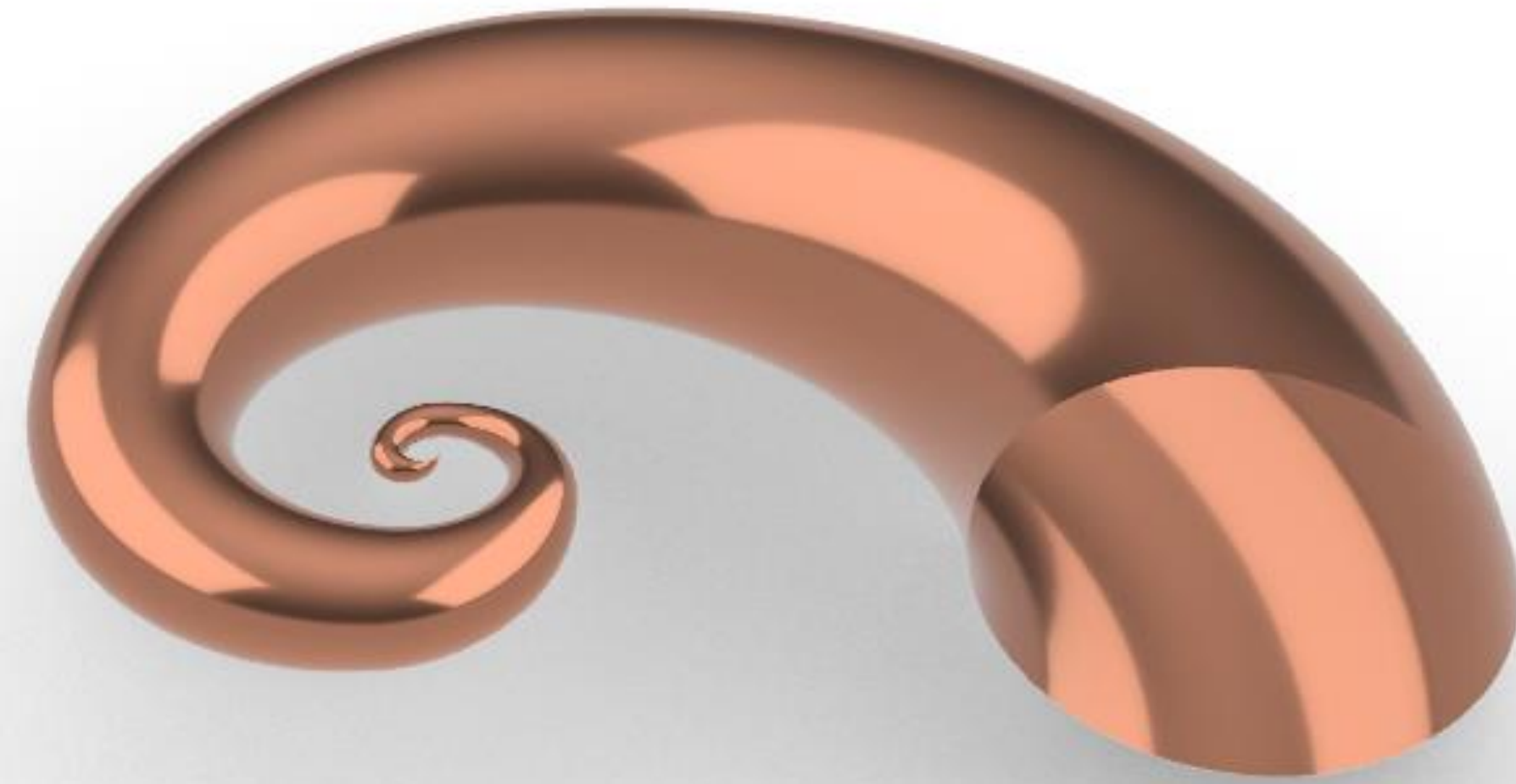

4.1 Spirula

Exerc. 4.1 – Spirula



4.1 Spirula

Exerc. 4.1 – Spirula



Exerc. 4.2 - Planorbis

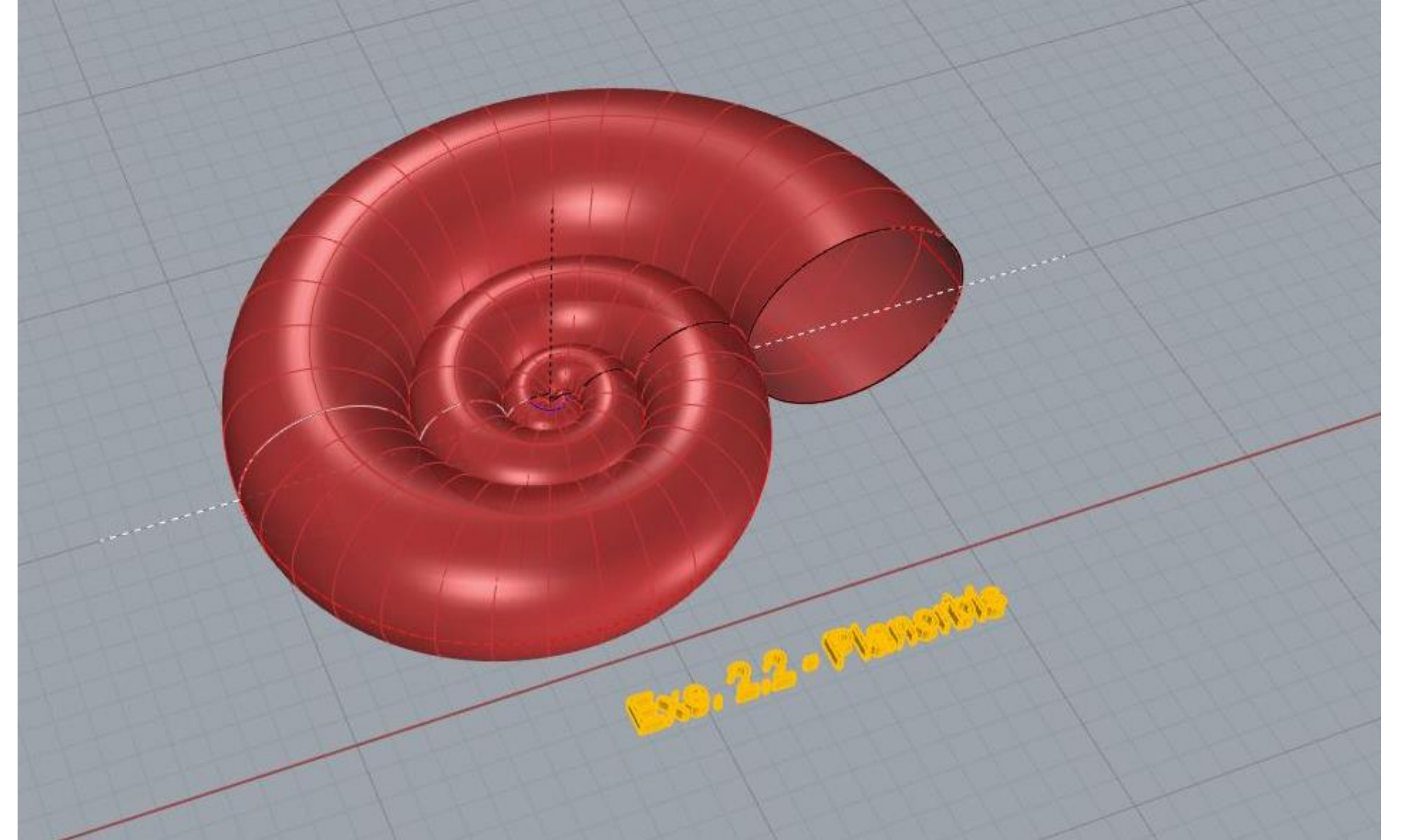
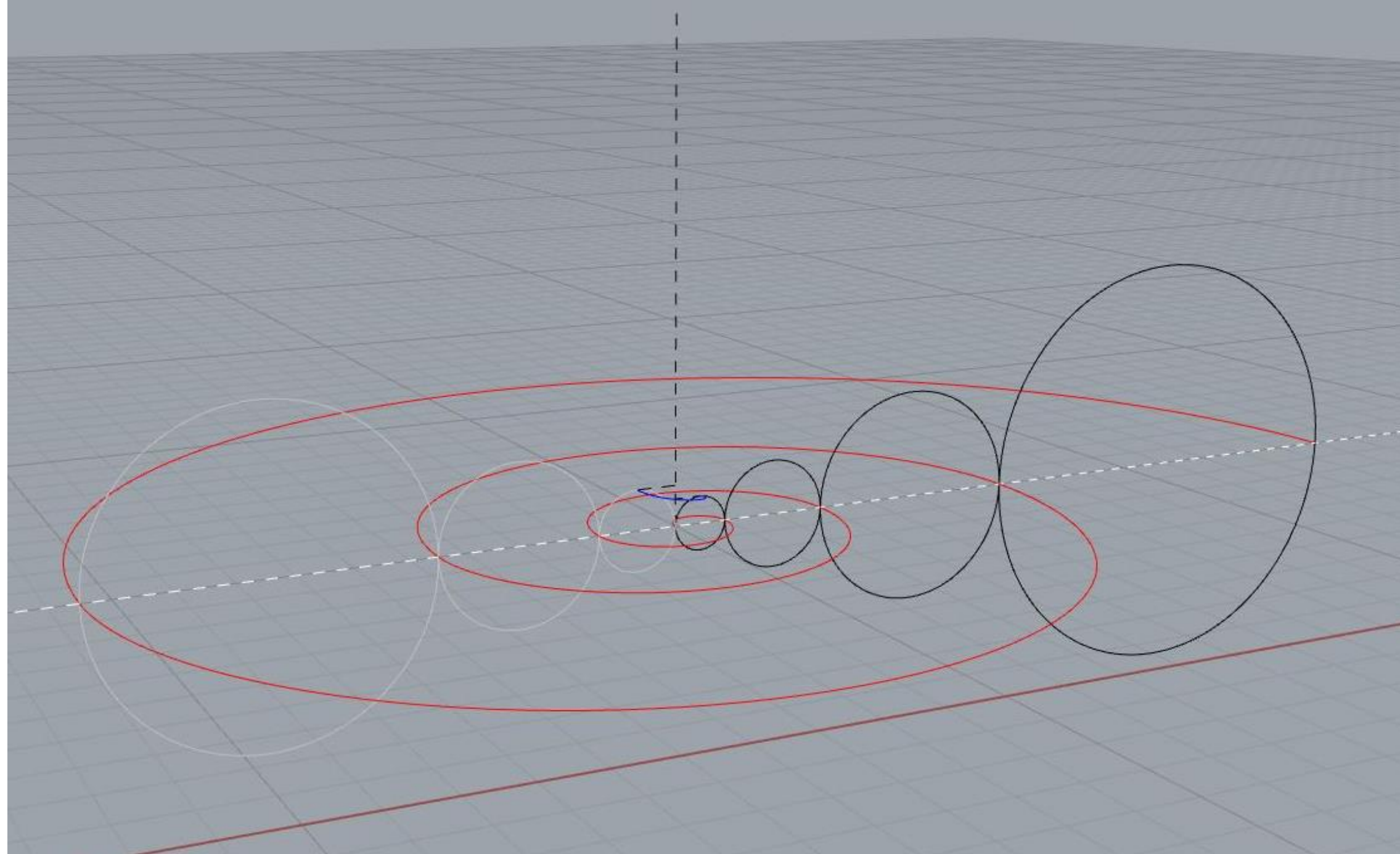

Exerc. 4.2 – Planorbis (Processo)

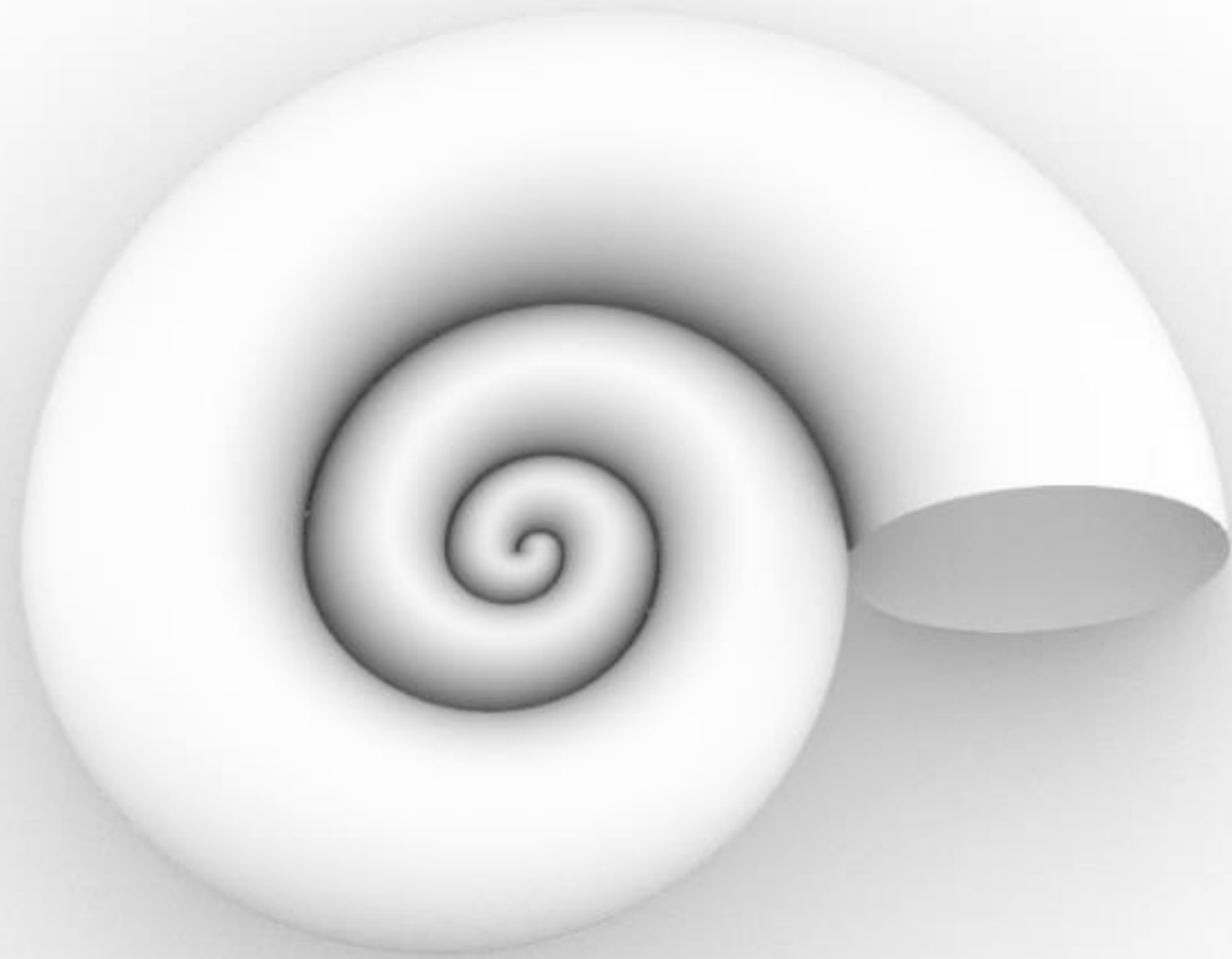

4.2 Planorbis

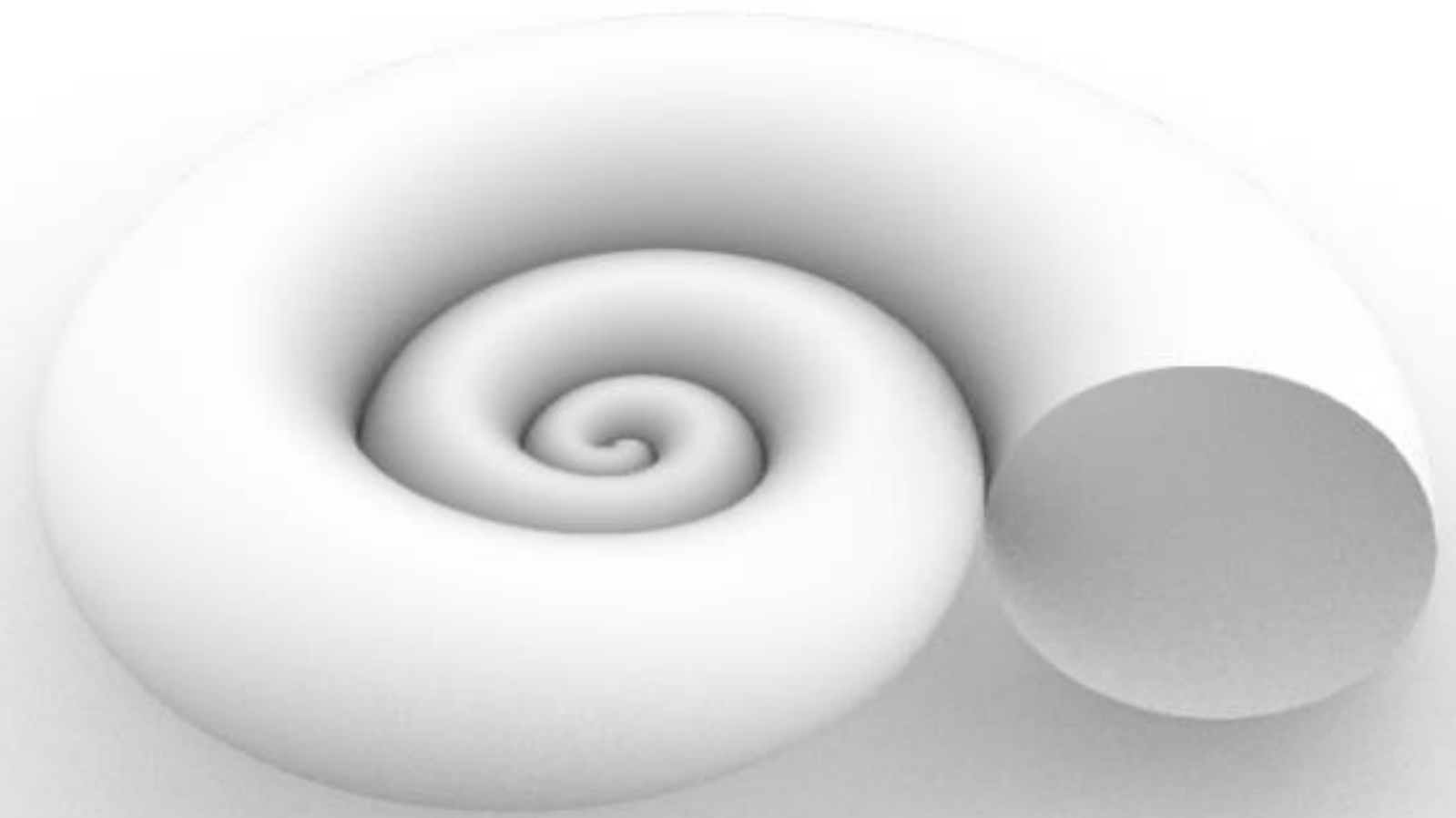

4.2 Planorbis

Exerc. 4.2 - Planorbis

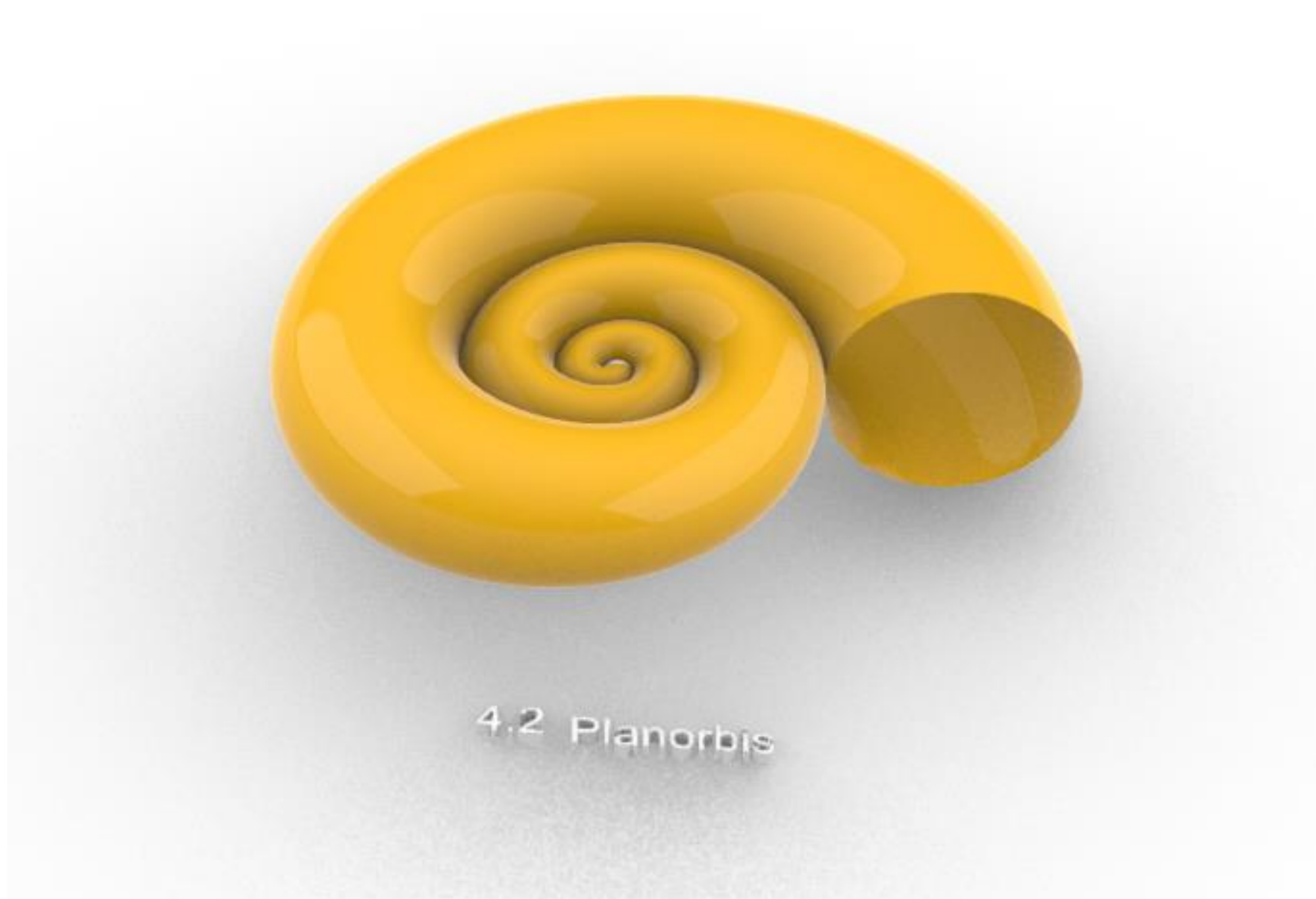

Exerc. 4.2 - Planorbis

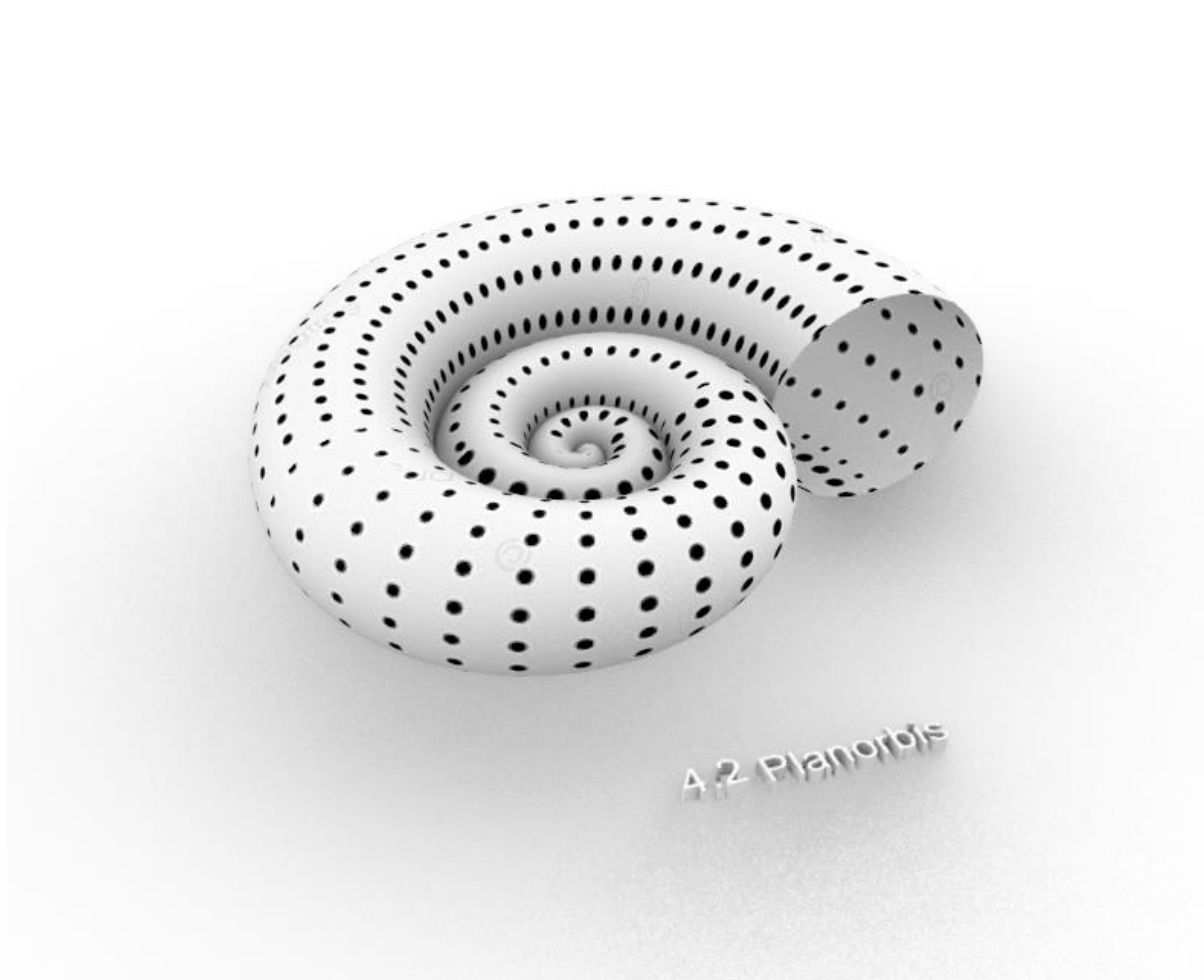

Exerc. 4.2 - Planorbis



Exerc. 4.3 - Nautilus

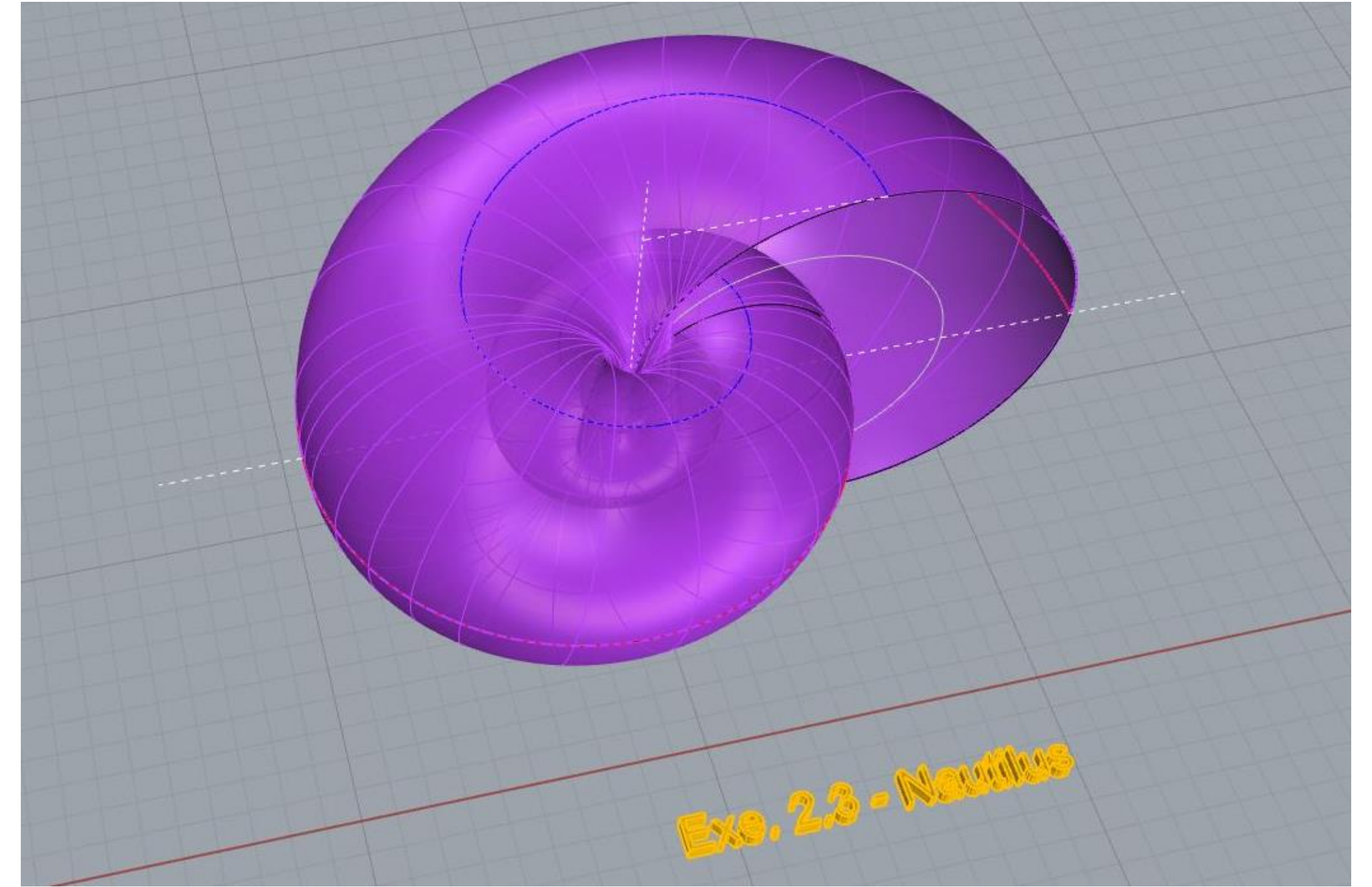
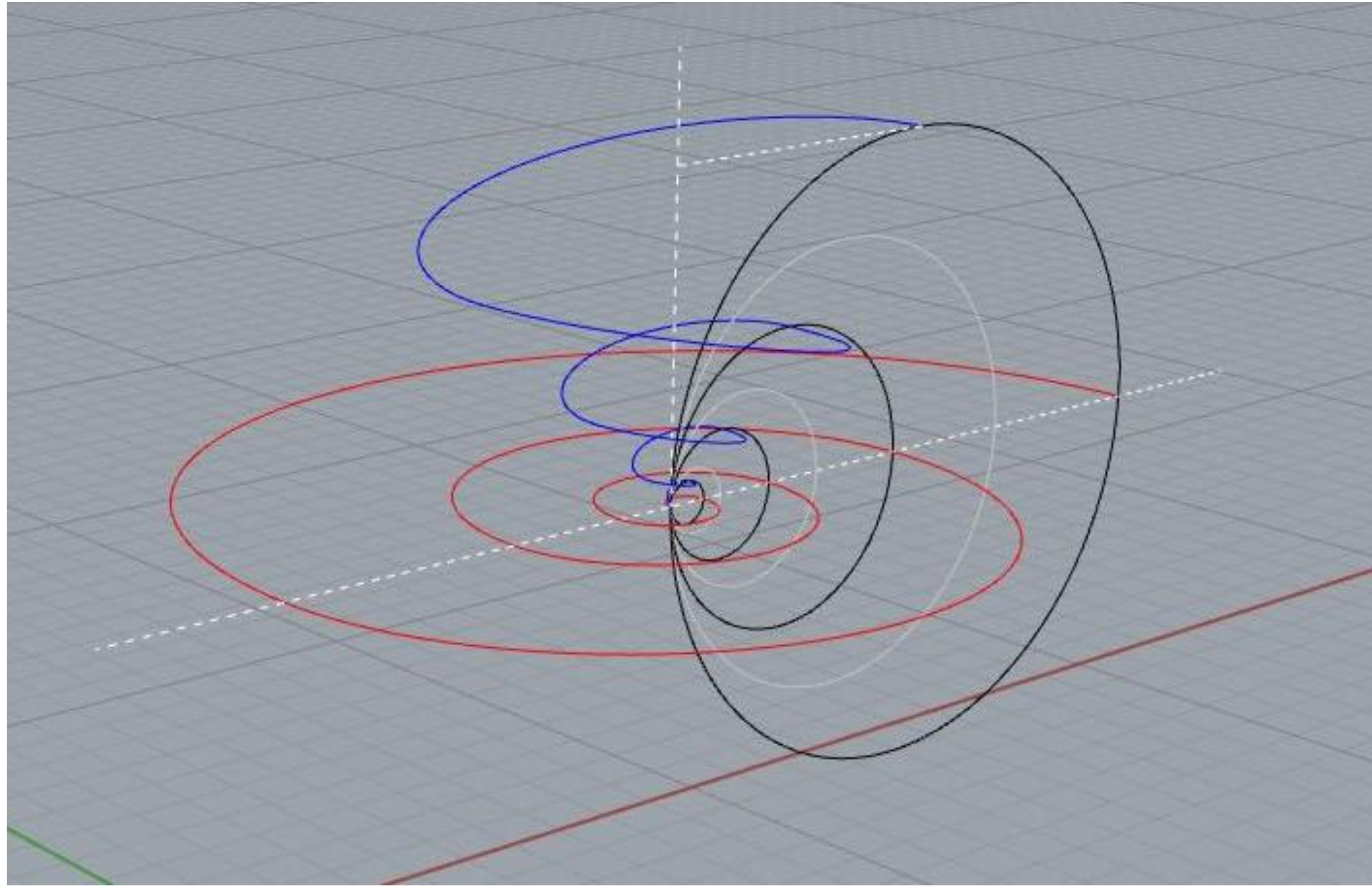

Exerc. 4.3 – Nautilus (Processso)

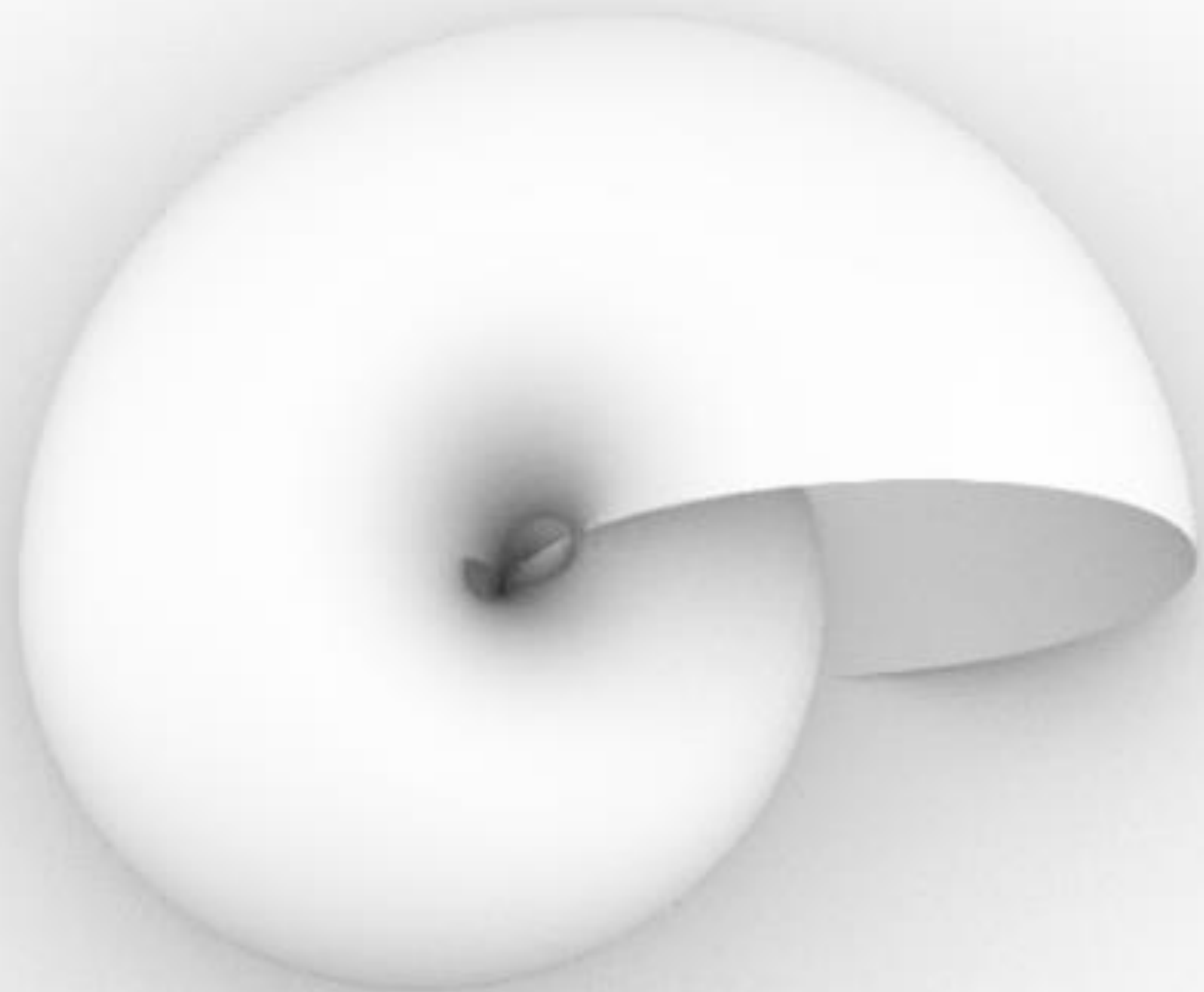

4.3 Nautilus

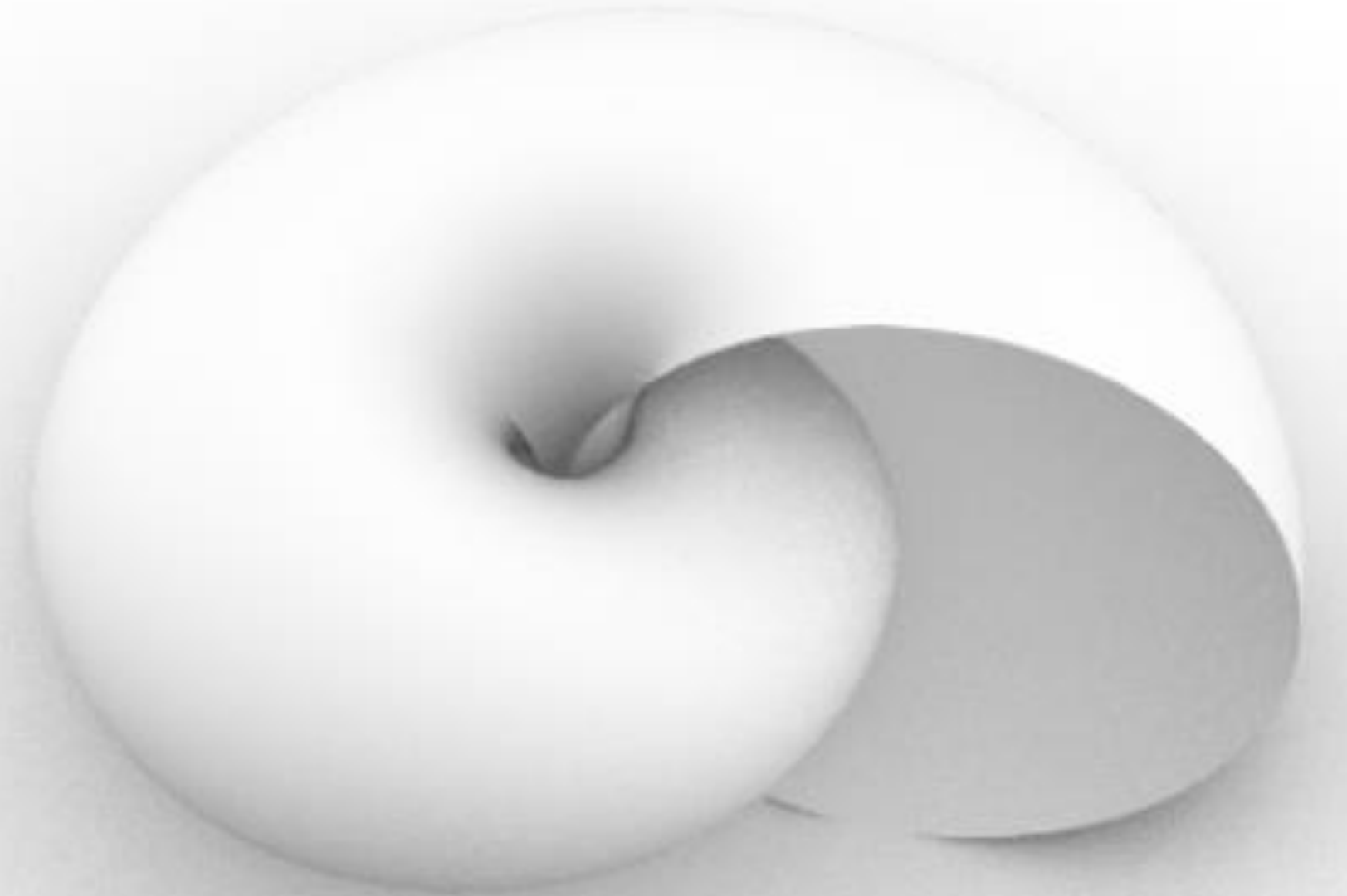

4.3 Nautilus

Exerc. 4.3 - Nautilus

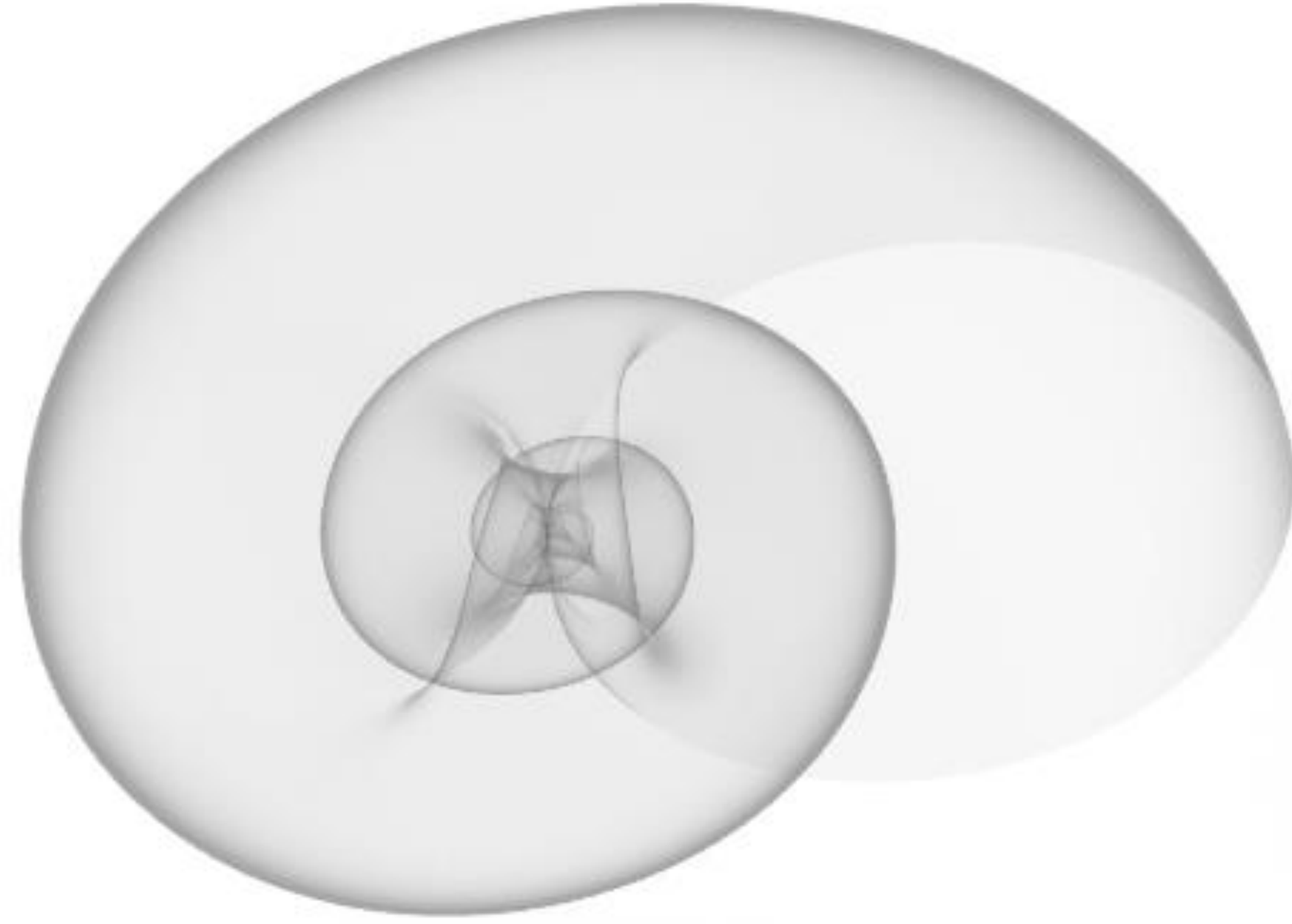

4.3 Nautilus

Exerc. 4.3 - Nautilus



Exerc. 4.4 - Caracol

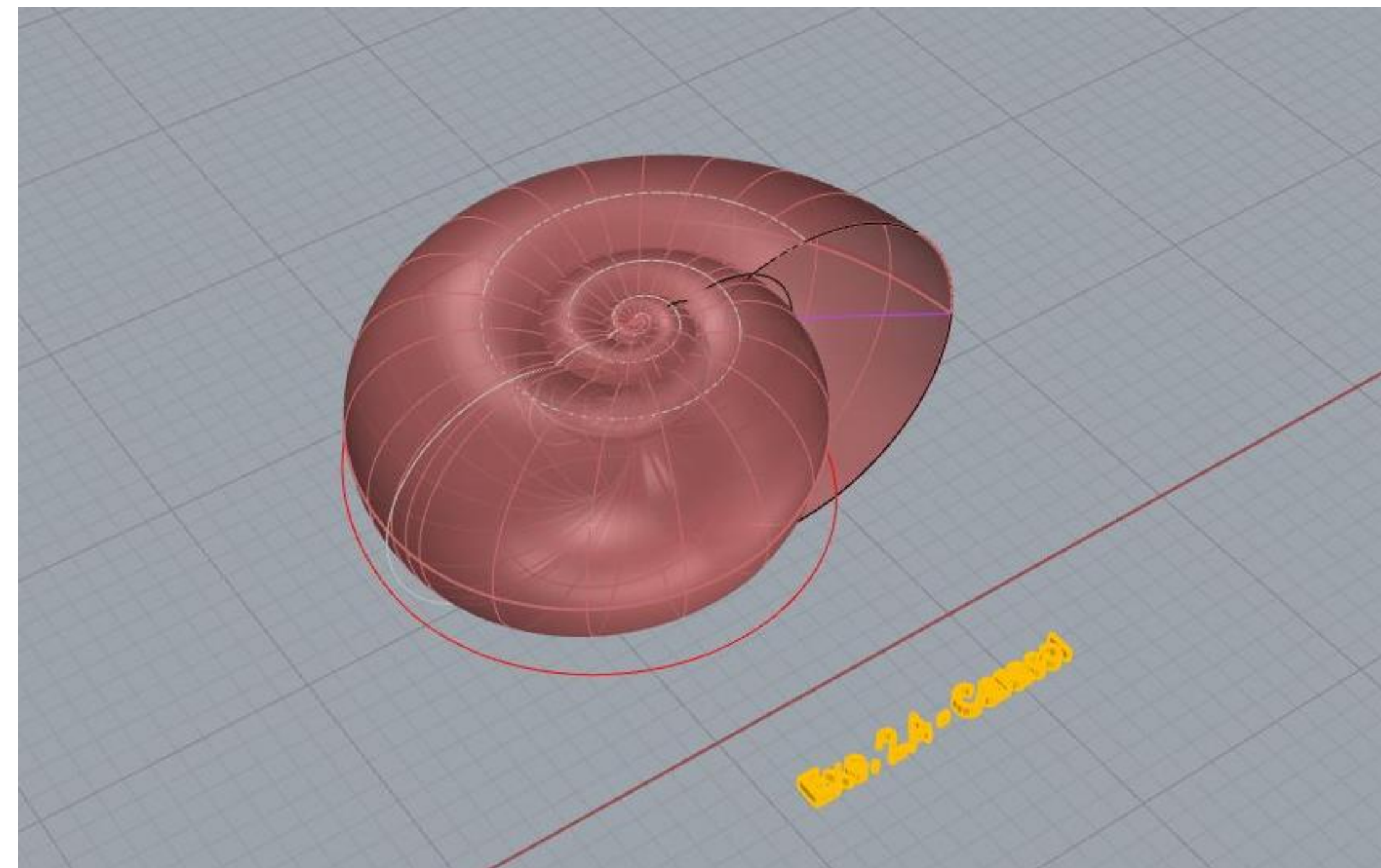
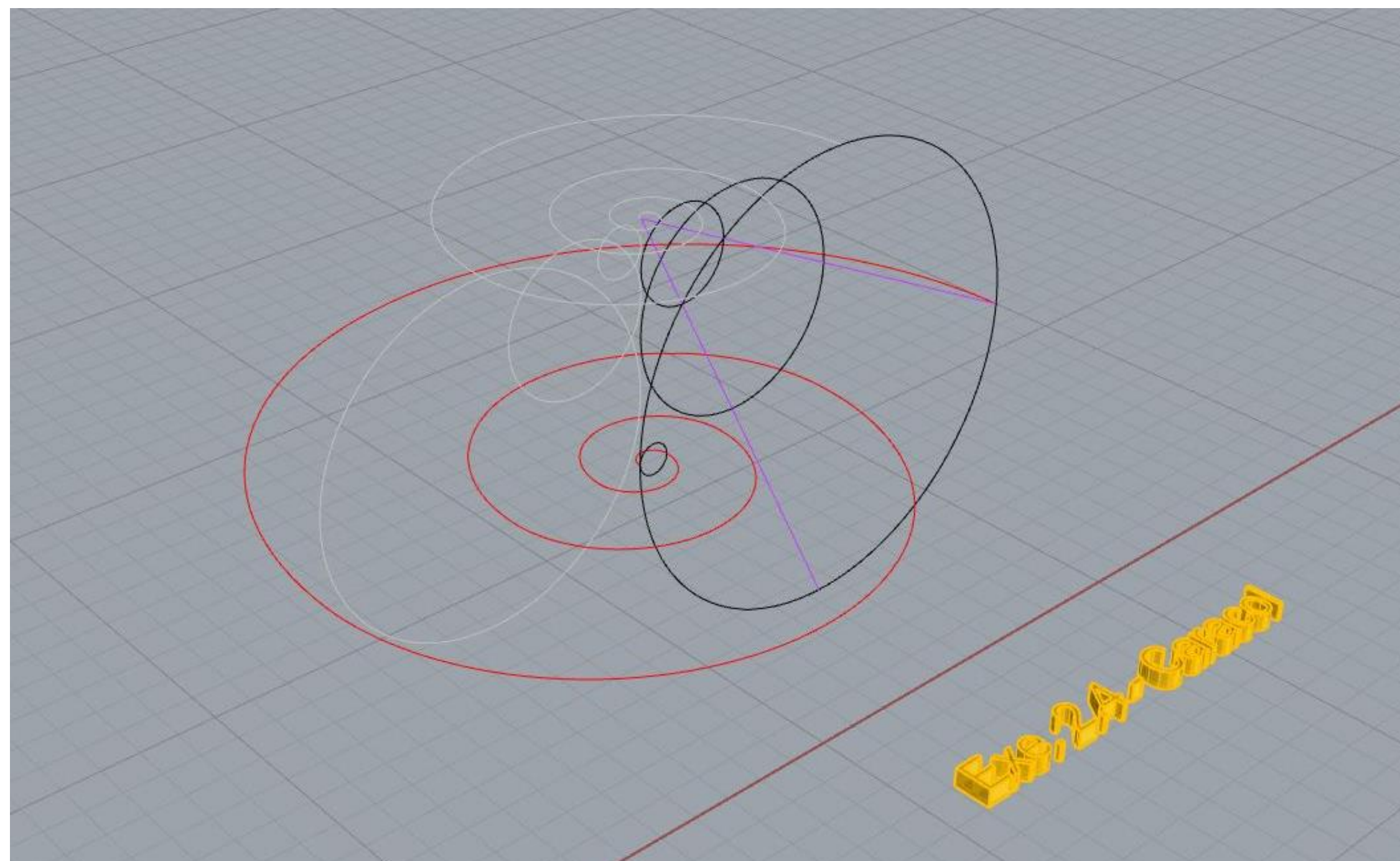

Exerc. 4.4 – Caracol (Processo)



Exerc. 4.4 - Caracol

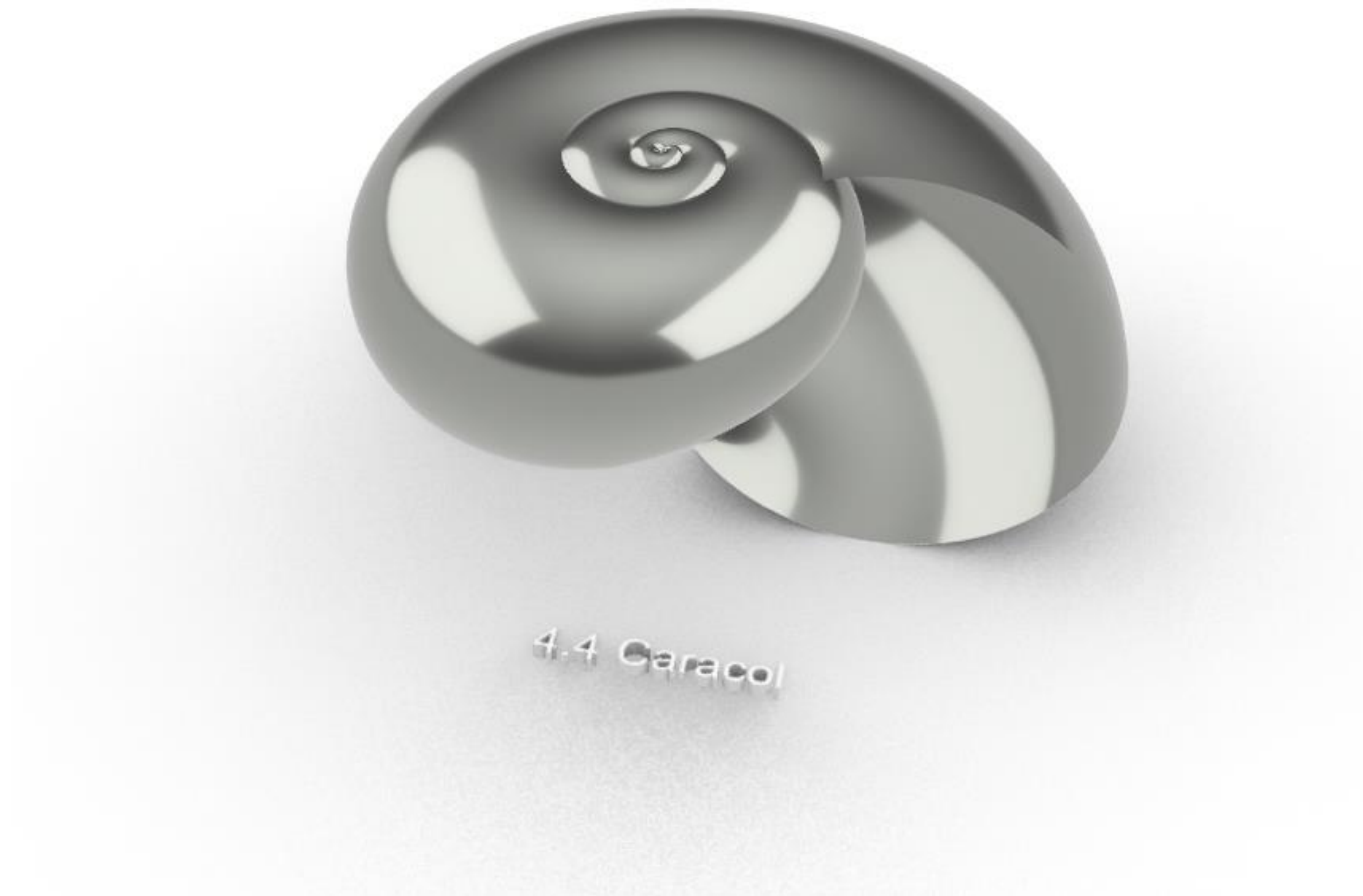

Exerc. 4.4 - Caracol



Exerc. 4.4 - Caracol



Exerc. 4.5 - Caramujo

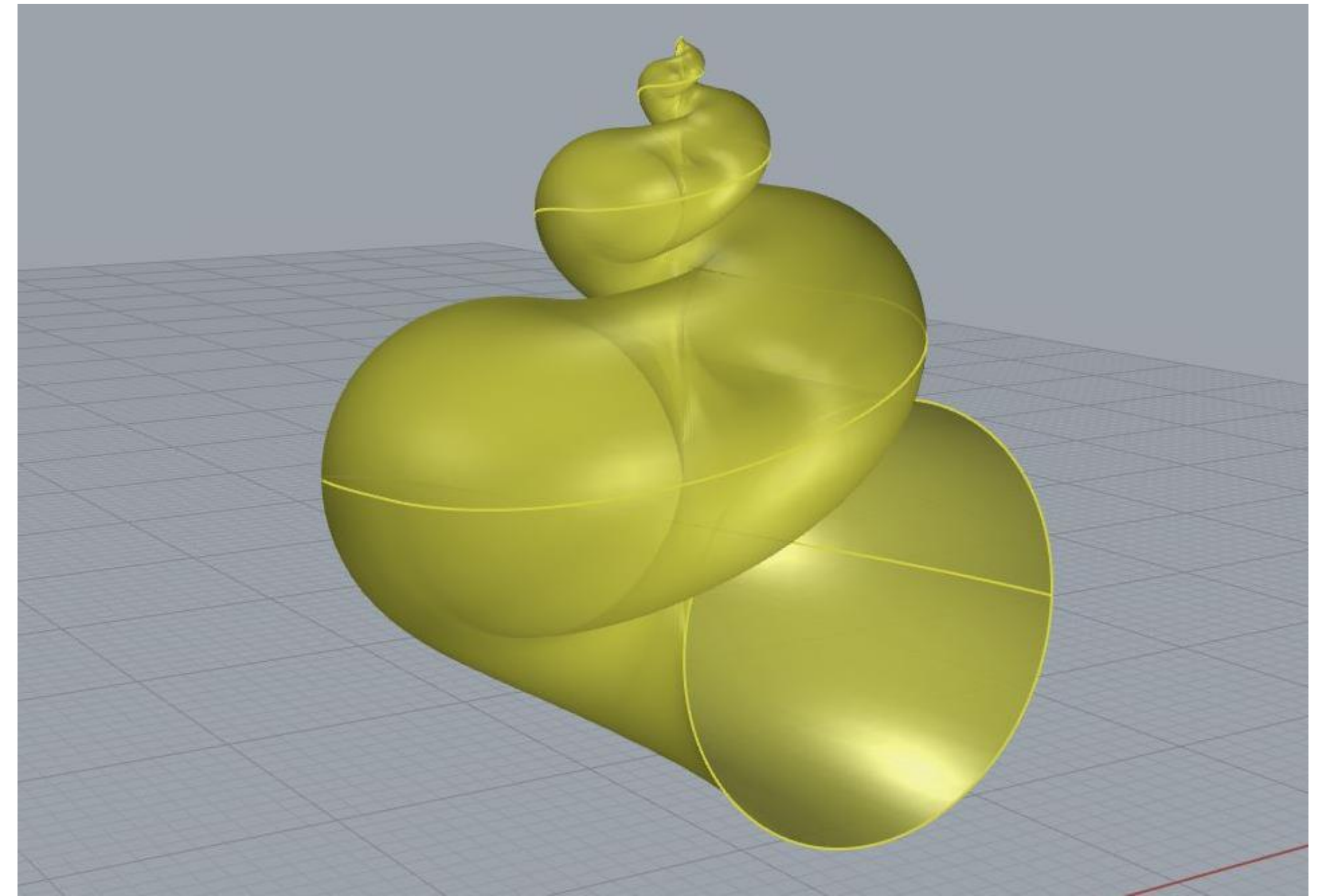
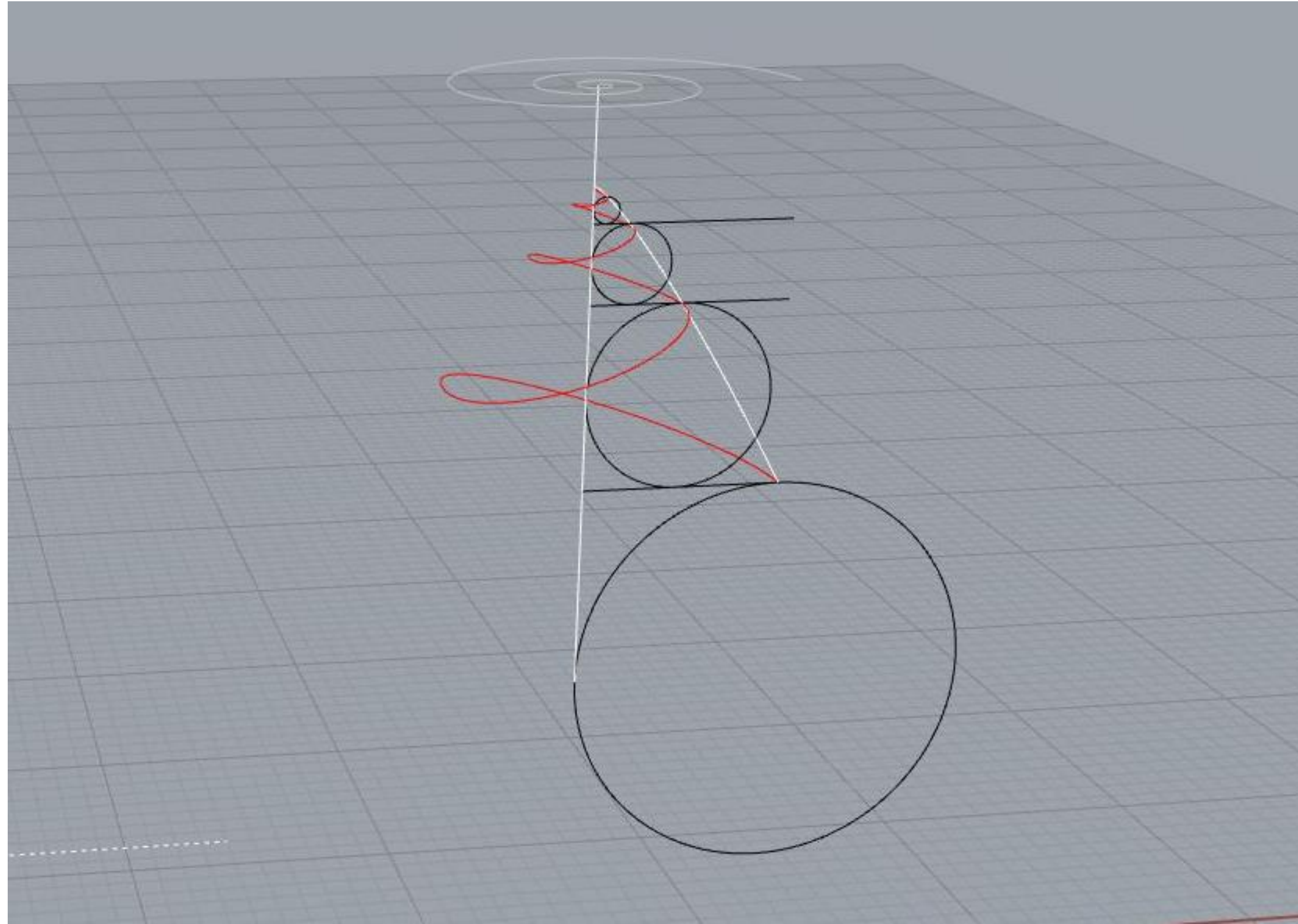

Exerc. 4.5 – Caramujo (Processo)

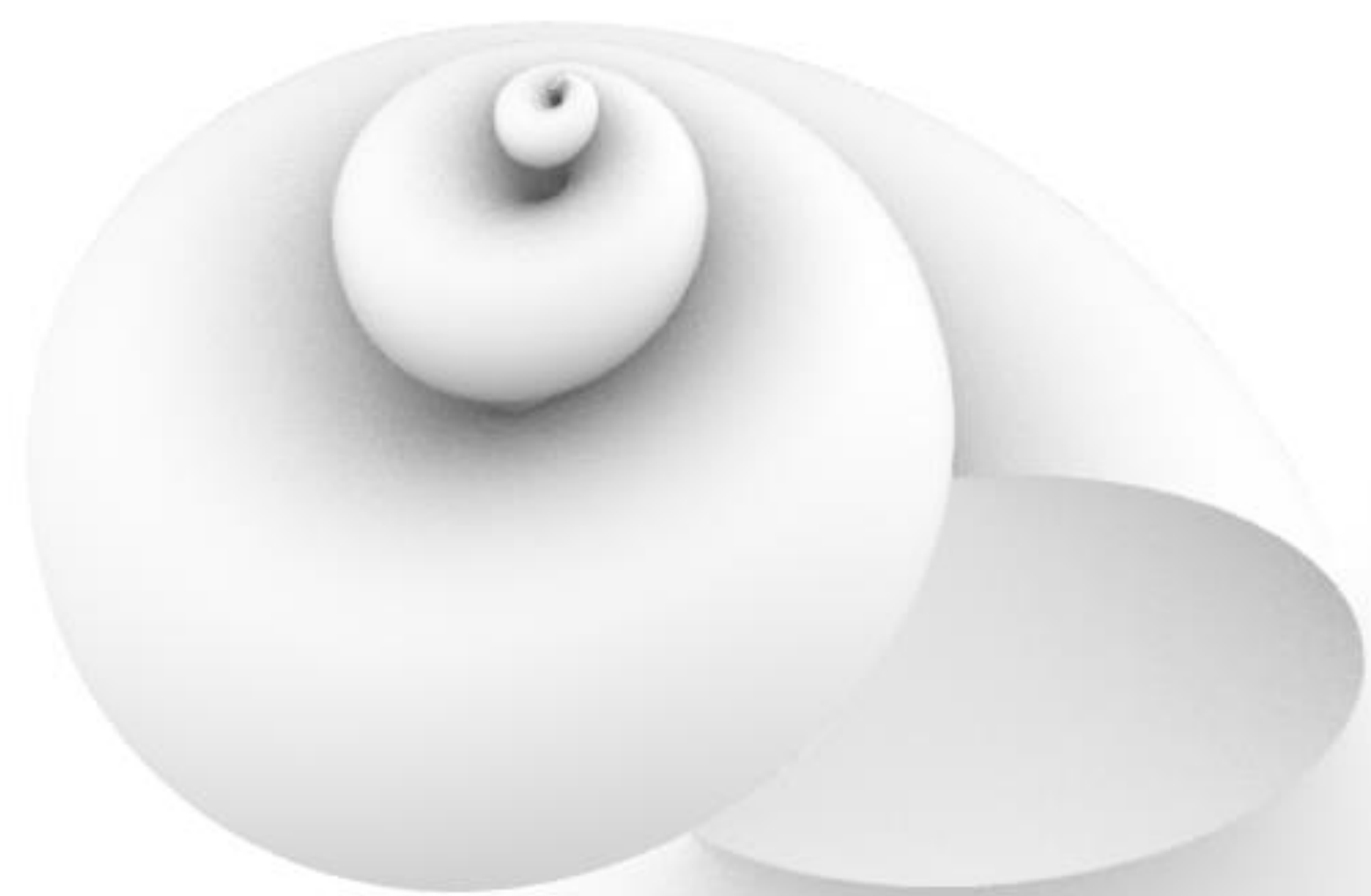

4.5 Caramujo

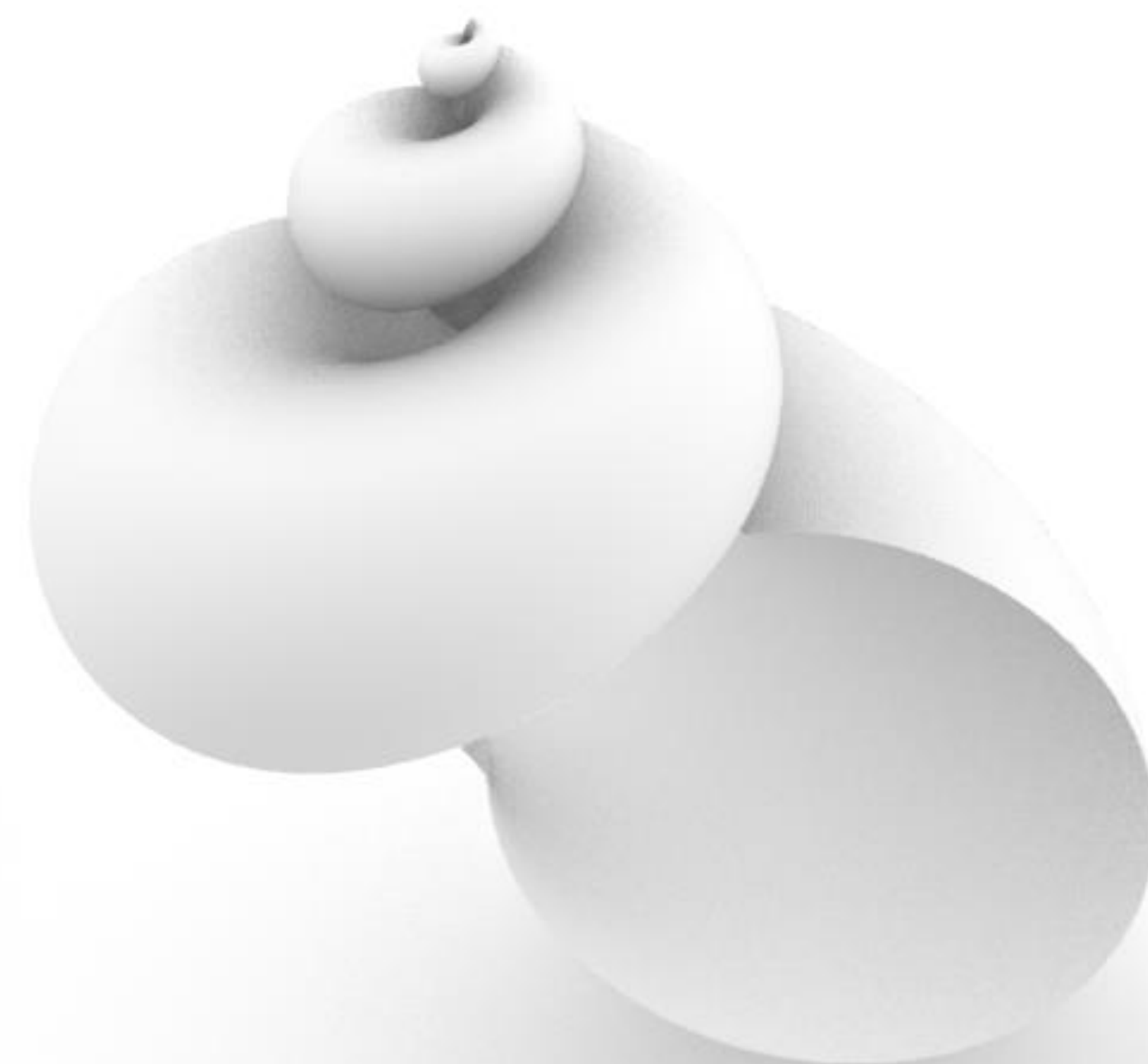

4.5 Caramujo

Exerc. 4.5 - Caramujo



4.5 Caramujo

Exerc. 4.5 - Caramujo



Exe. 5.1 - Conchas Bivalves Mexilhão



Exe. 5.2 - Conchas Bivalves Amêijoá



Exe. 5.3 - Conchas Bivalves Vieira



Exe. 5.4 - Conchas Bivalves Ostra

Exerc. 5 – CONCHAS BIVALVES



Exerc. 5.1 - Mexilhão

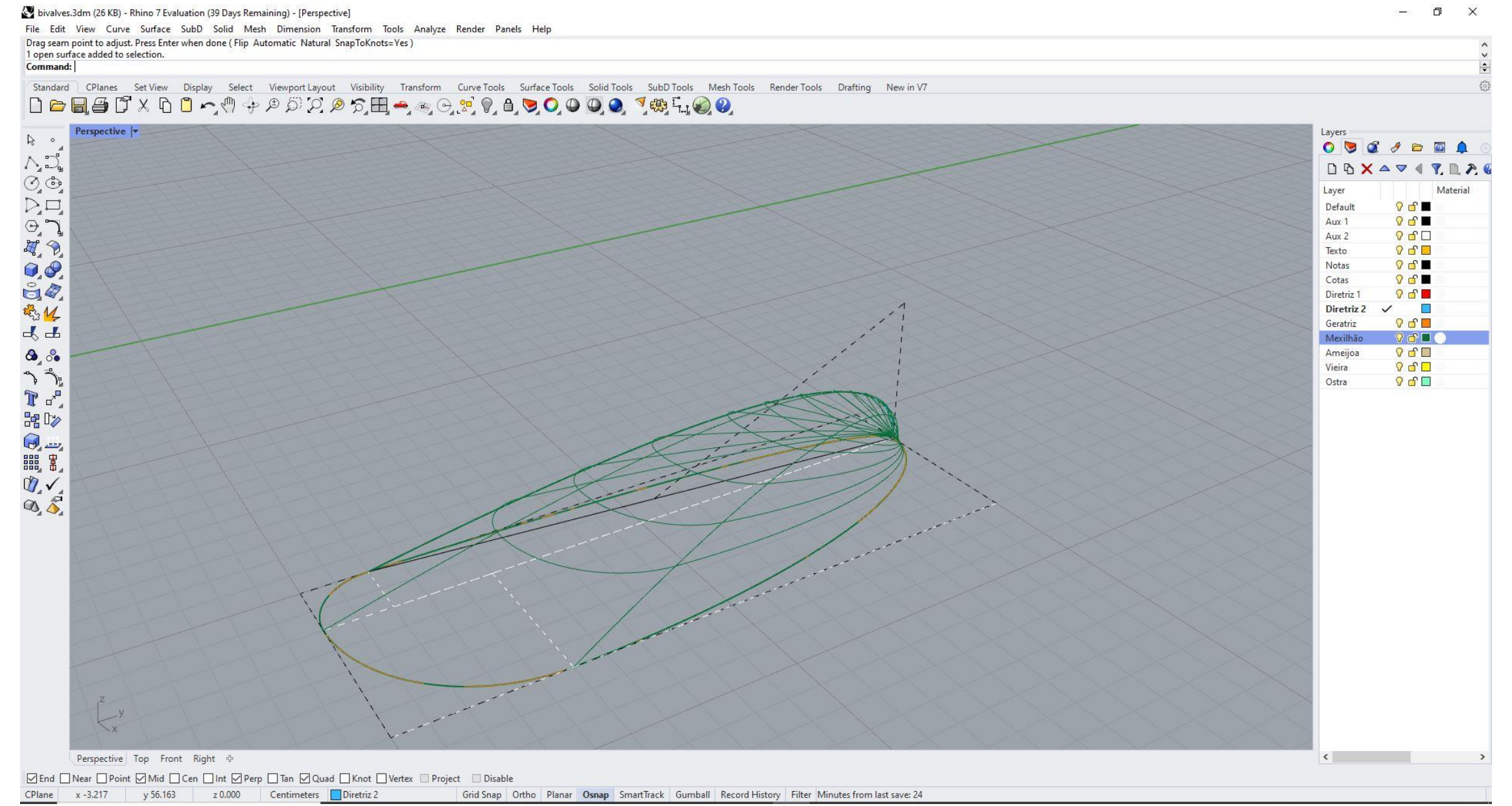
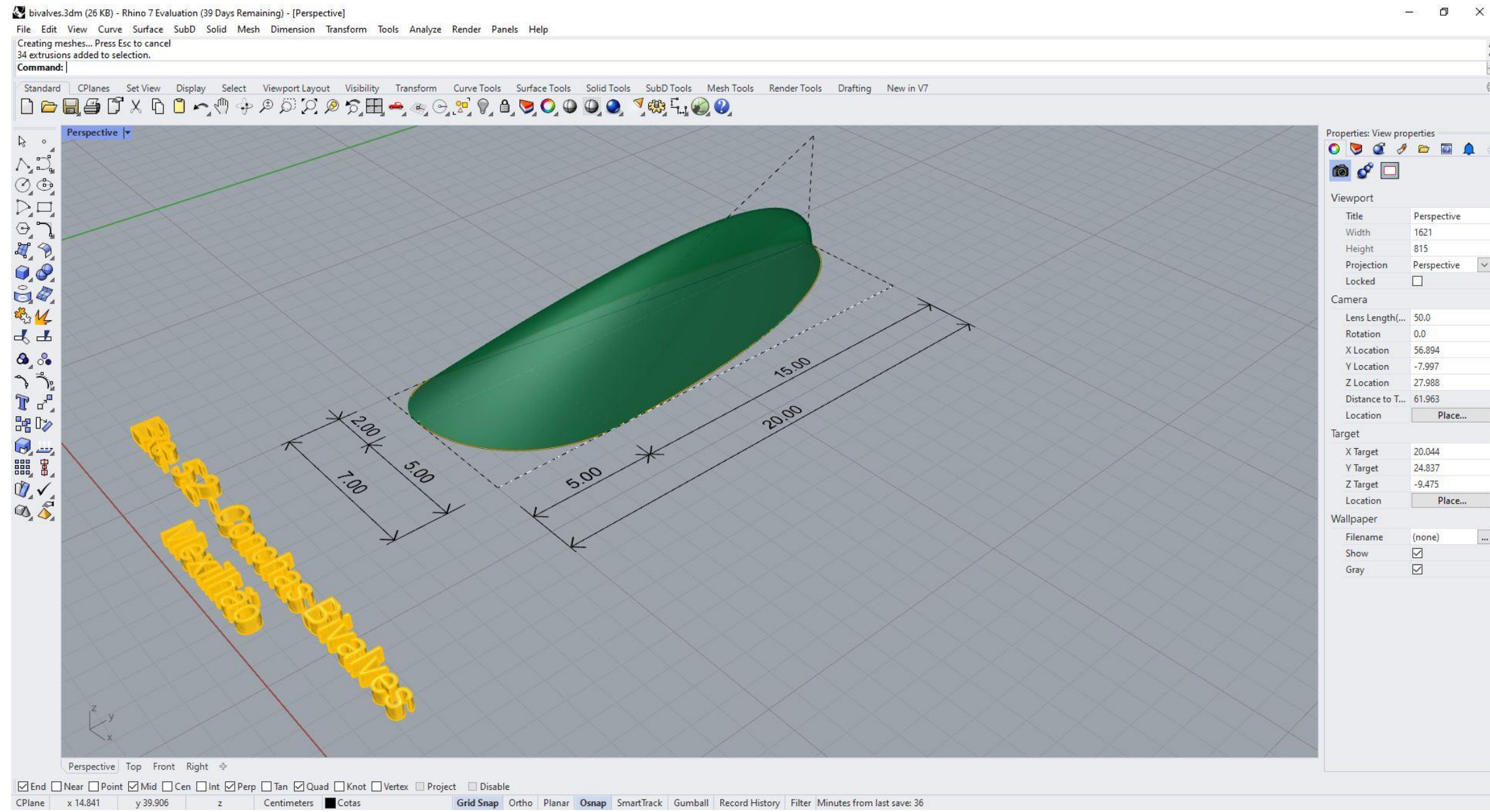

Exerc. 5.1 – Mexilhão (Processo)



Exe. 5.1 - Conchas Bivalves
Mexilhão



Exe. 5.1 - Conchas Bivalves
Mexilhão

Exerc. 5.1 - Mexilhão

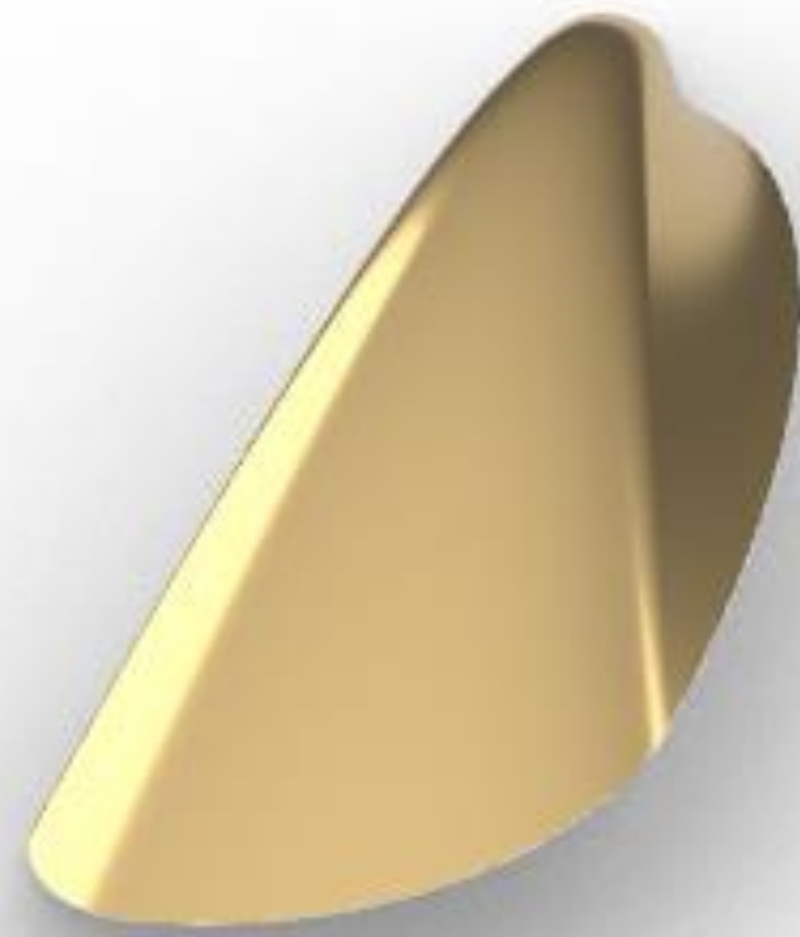

Exe 5.1 - Conchas Bivalves
Mexilhão

Exerc. 5.1 - Mexilhão



016 017 Conchas Bivalves
Mexilhão

Exerc. 5.1 - Mexilhão



Exerc. 5.2 - Ameijoa

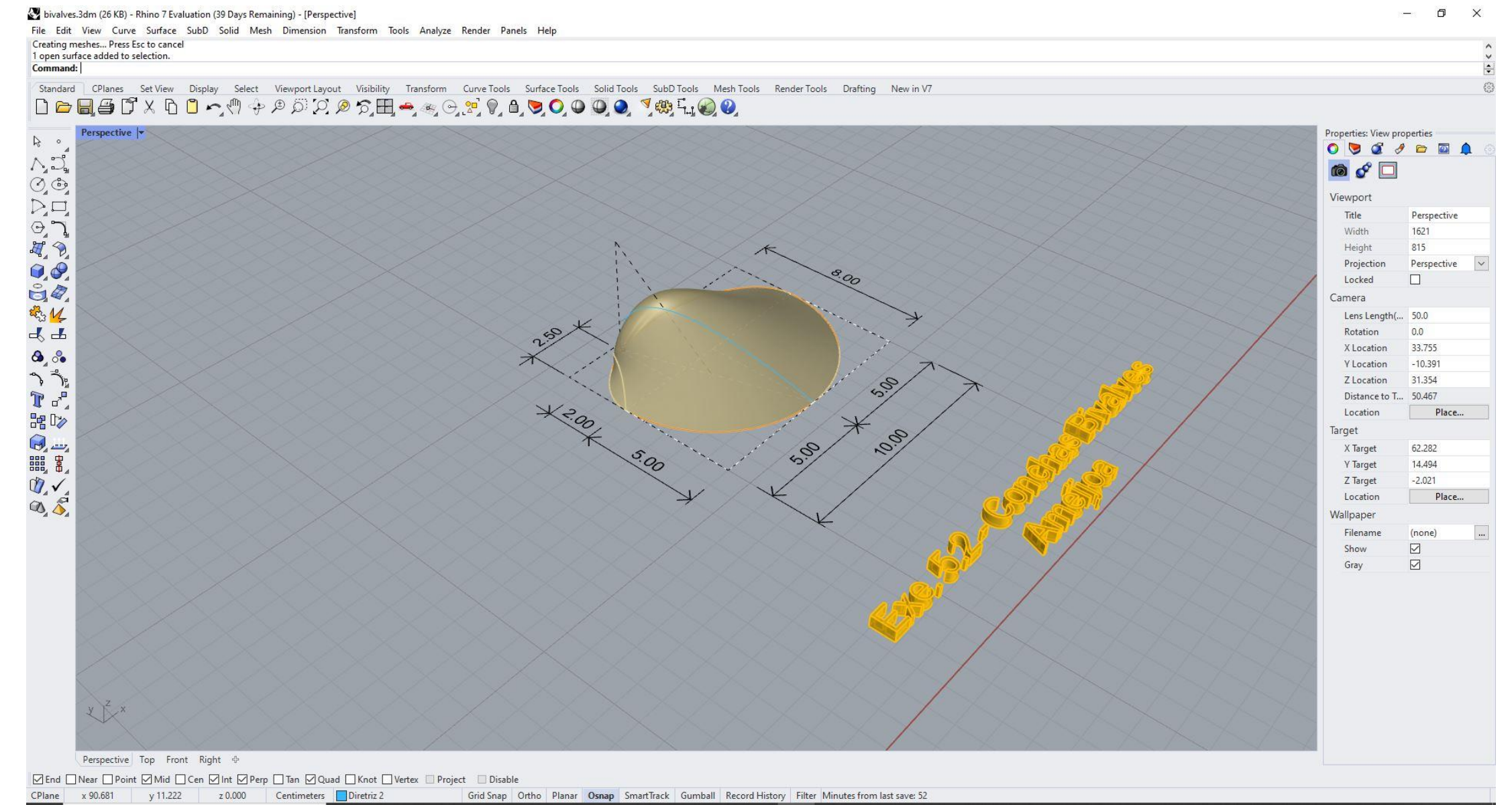
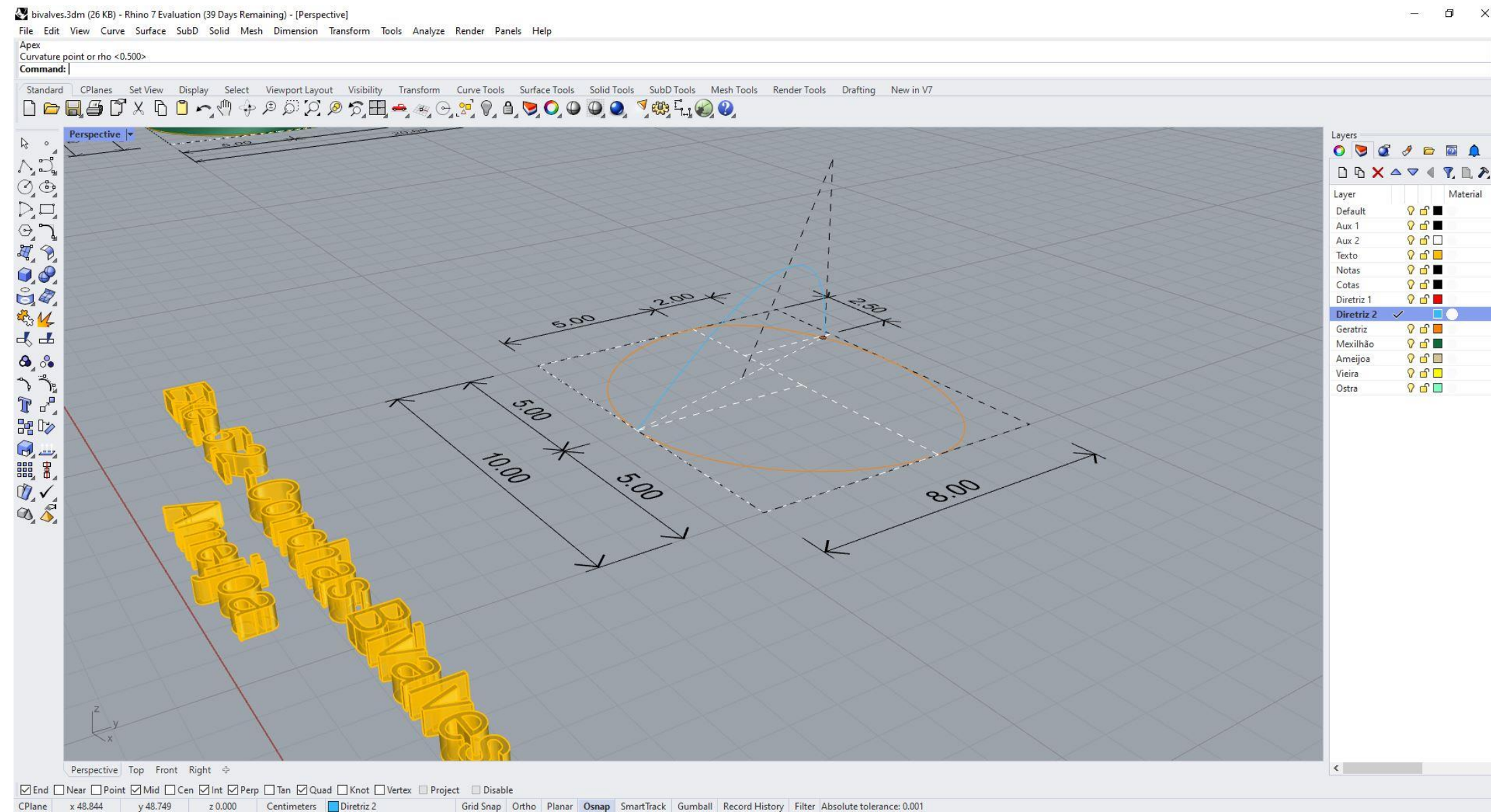

Exerc. 5.2 – Ameijoas (Processo)



Exe. 5.2 - Conchas Bivalves
Ameijoa



Exe. 5.2 - Conchas Bivalves
Ameijoa

Exerc. 5.2 - Ameijoa

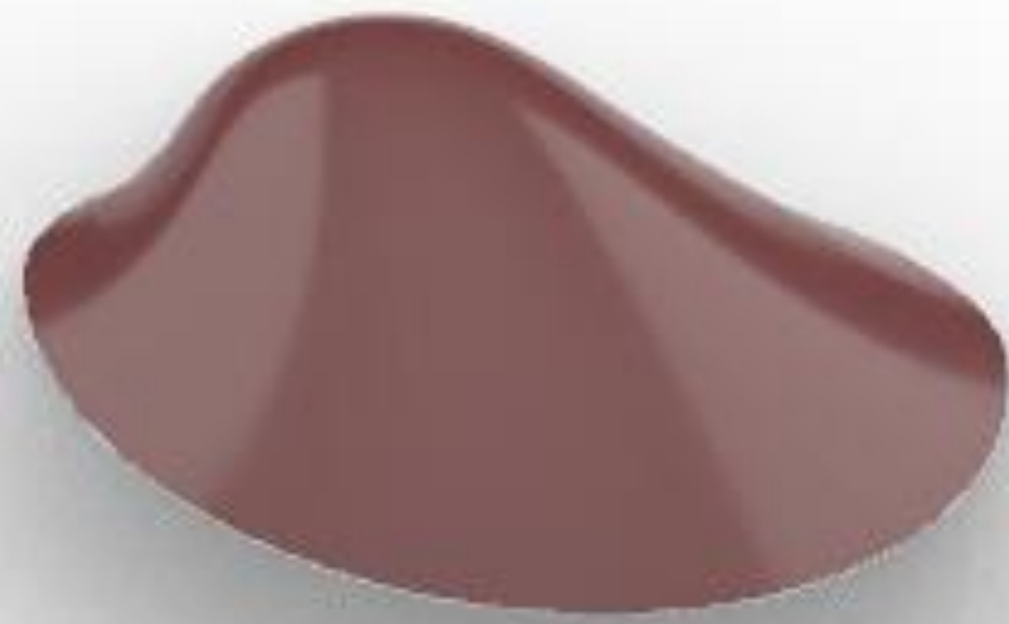

Exe. 5.2 - Conchas Bivalves
Ameijoa

Exerc. 5.2 - Ameijoa

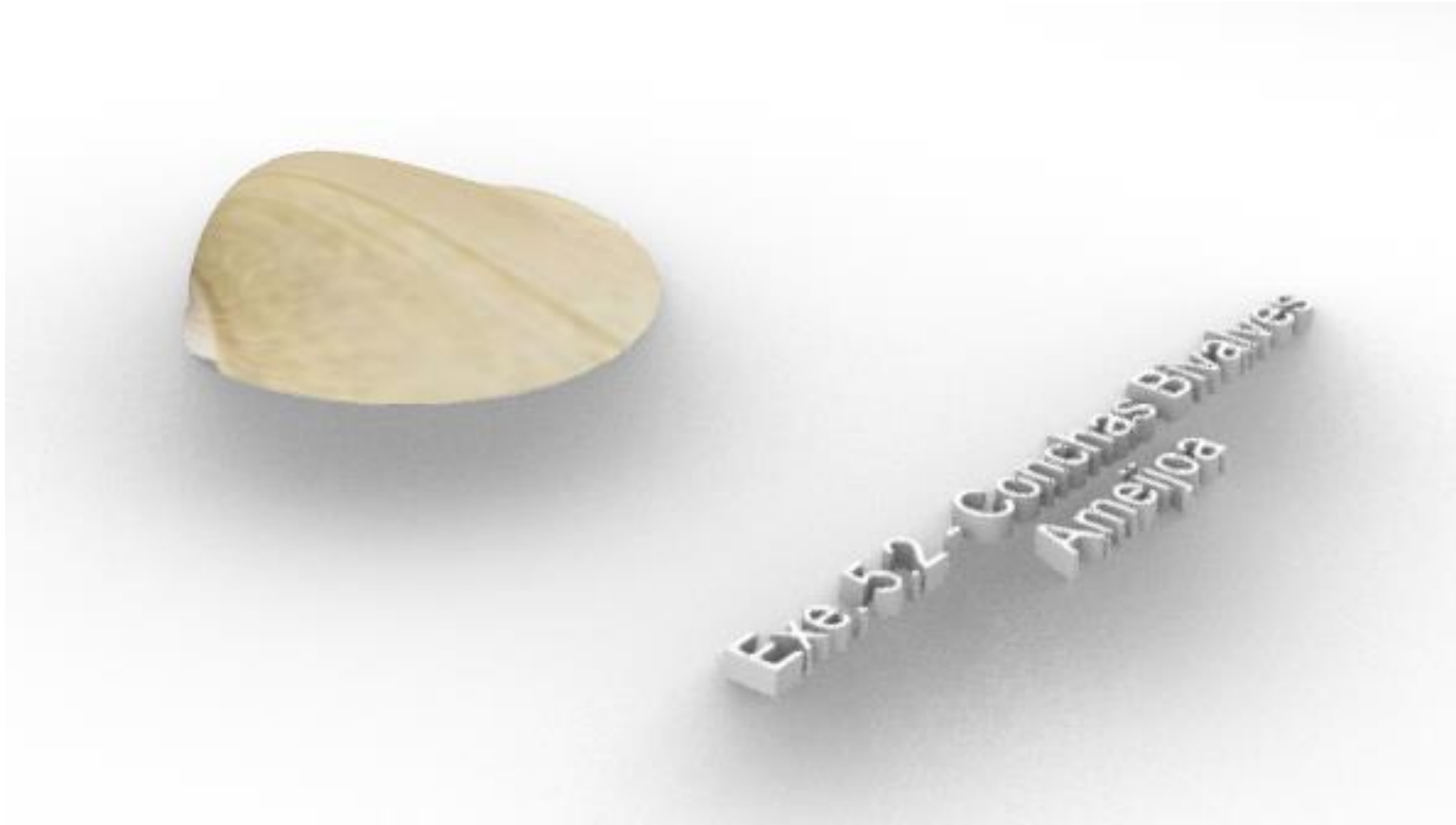

Exerc. 5.2 - Ameijoas



Exerc. 5.3 - Vieira

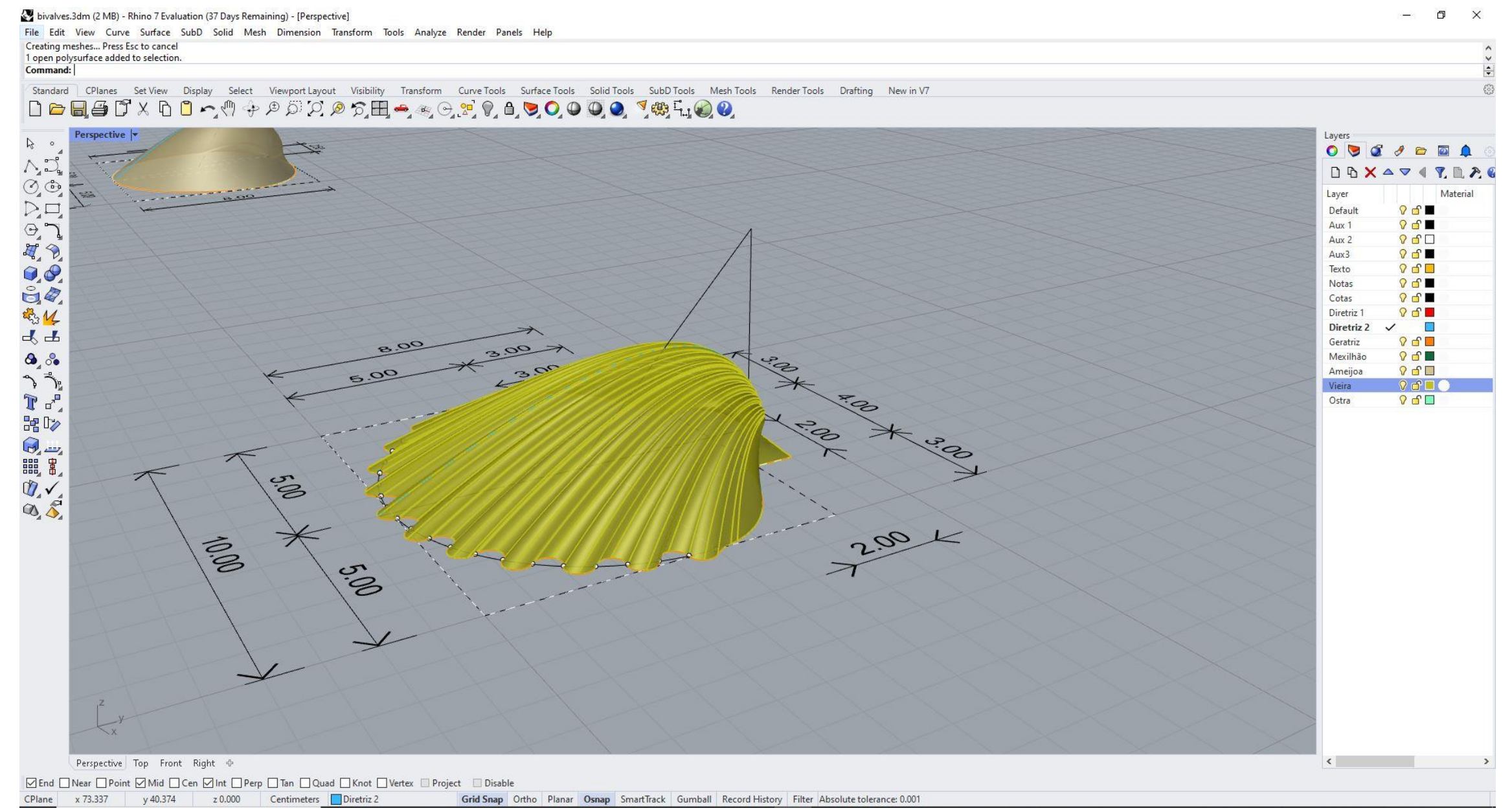
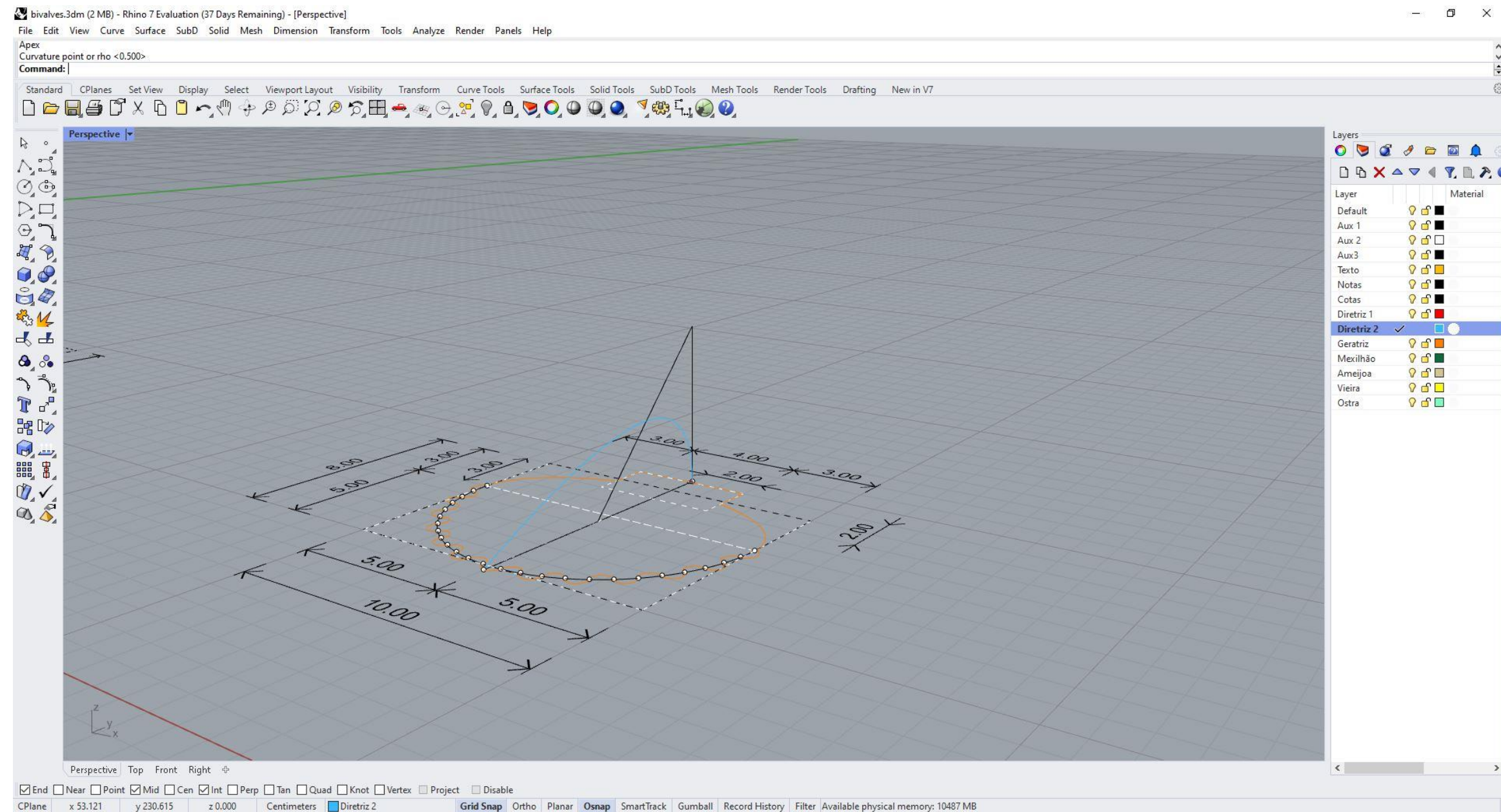

Exerc. 5.3 – Vieira (Processo)

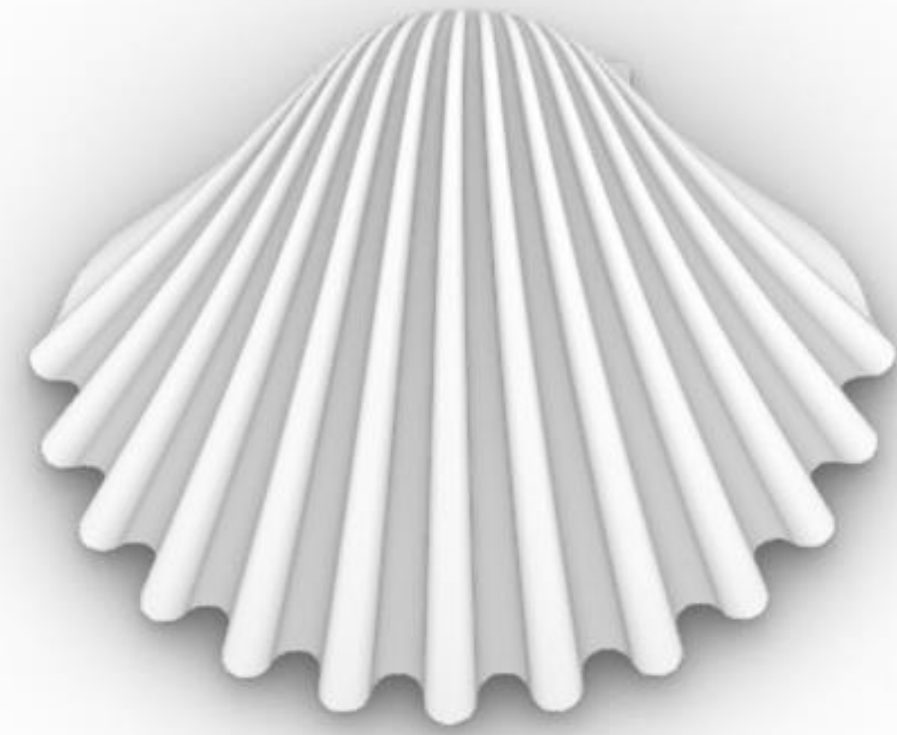

Exe. 5.3 - Conchas Bivalves
Vieira



Exerc. 5.3 - Vieira



Exe 5.3 - Conchas Bivalves
Vieira

Exerc. 5.3 - Vieira



Exerc. 5.4 - Ostra

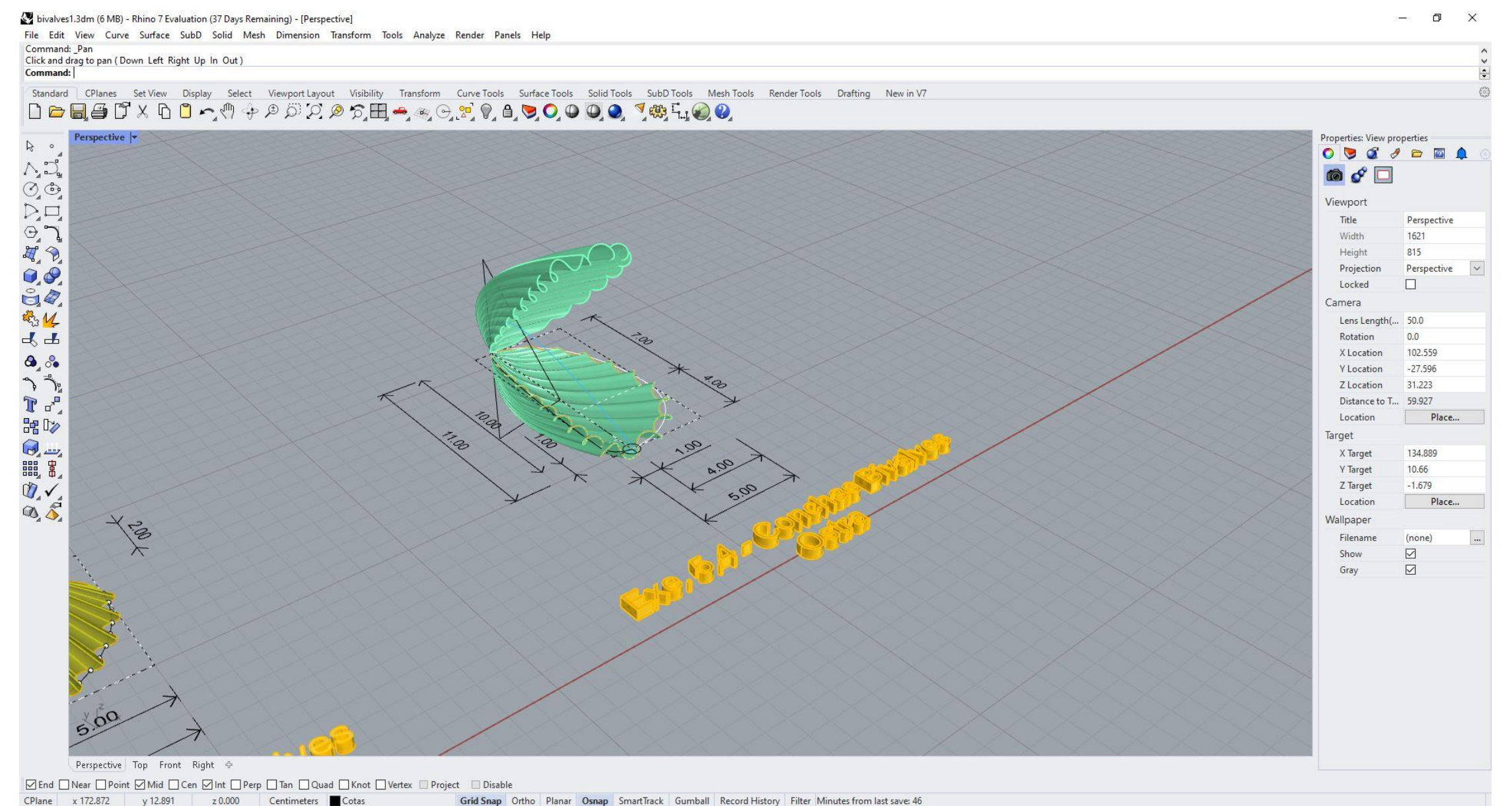
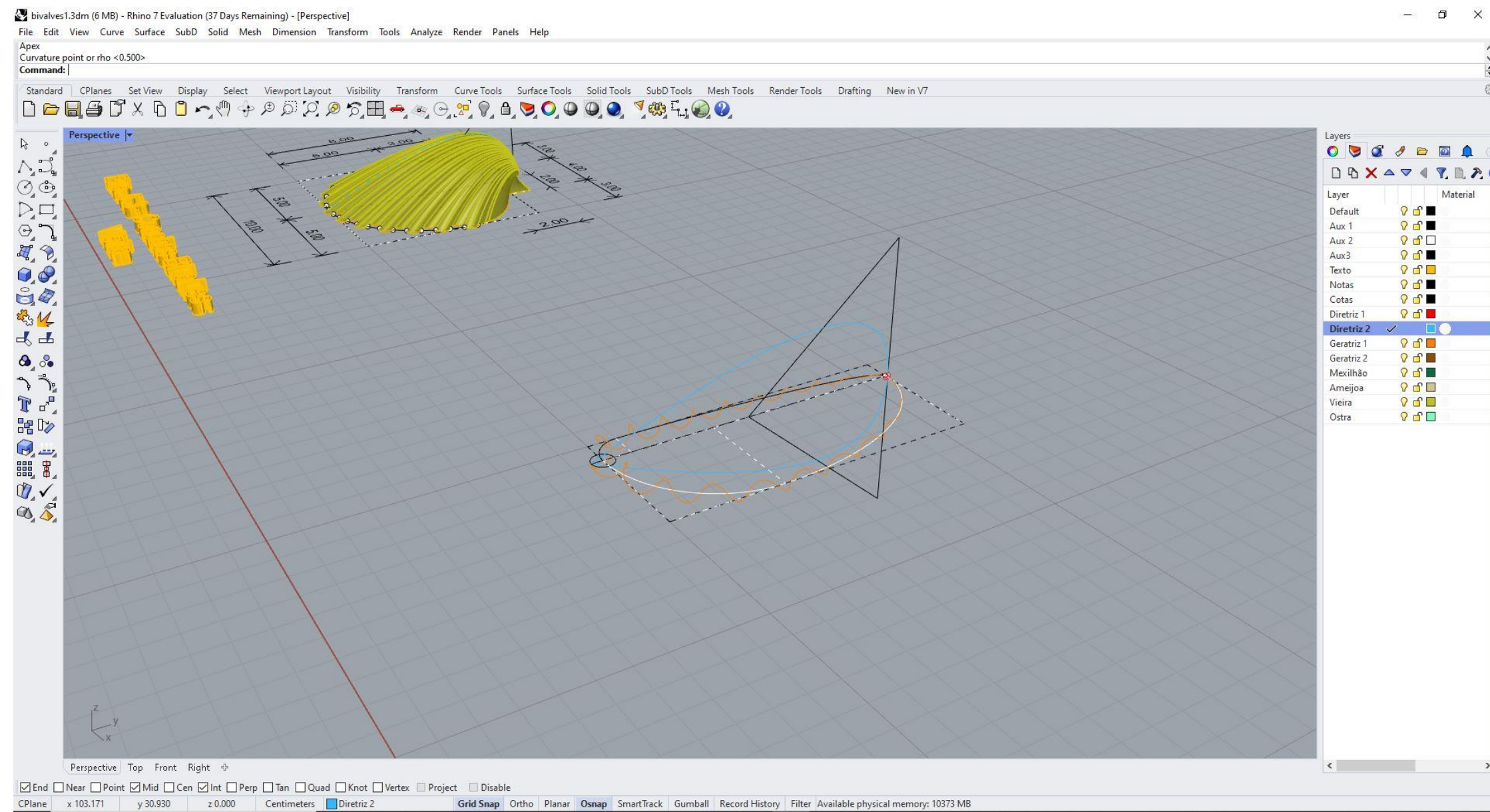

Exerc. 5.4 – Ostra (Processo)



Exe. 5.4 - Conchas Bivalves
Ostra

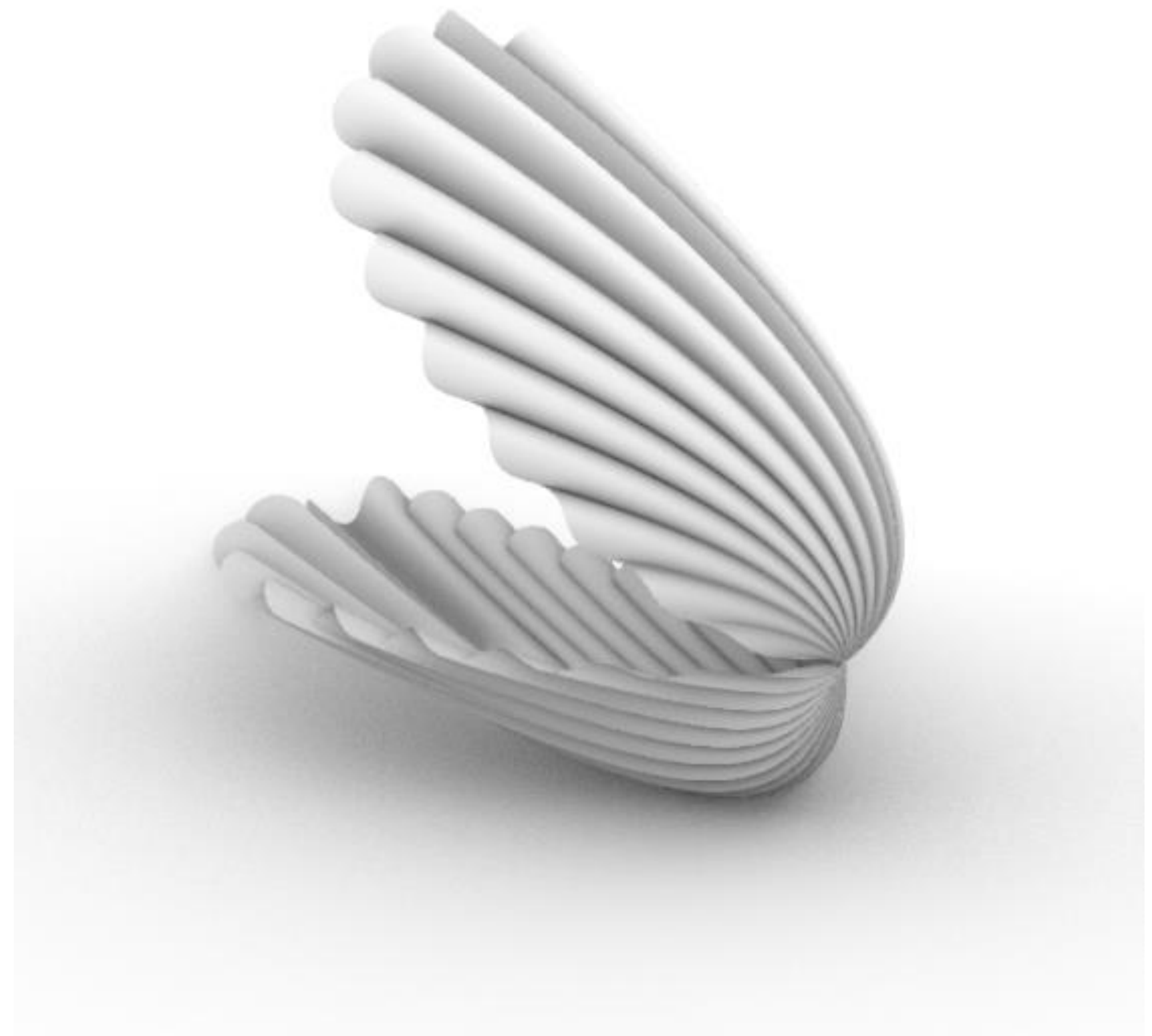

Exerc. 5.4 - Ostra

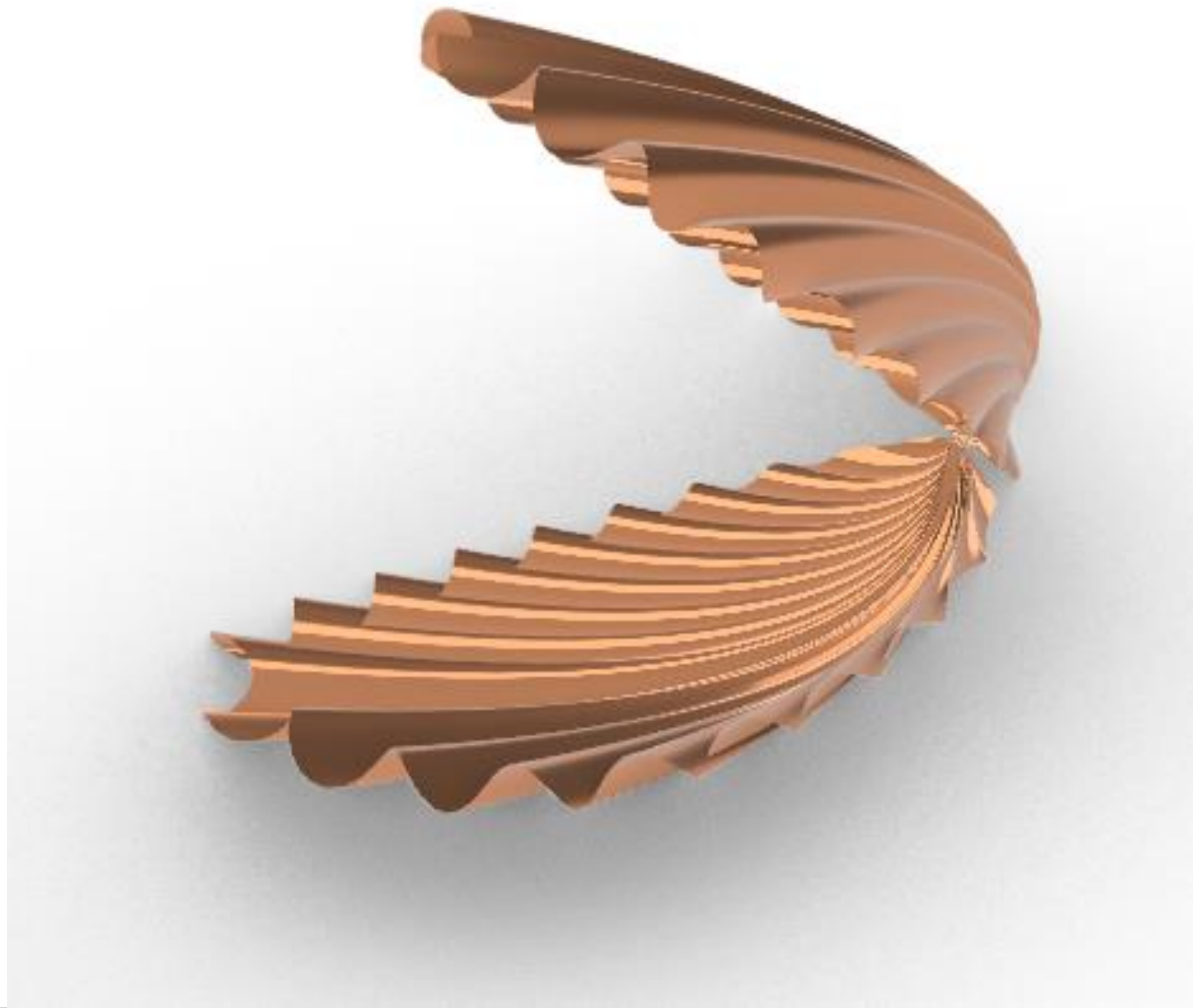

Exerc. 5.4 - Ostra



Exerc. 6 – Caramujo no Grasshopper

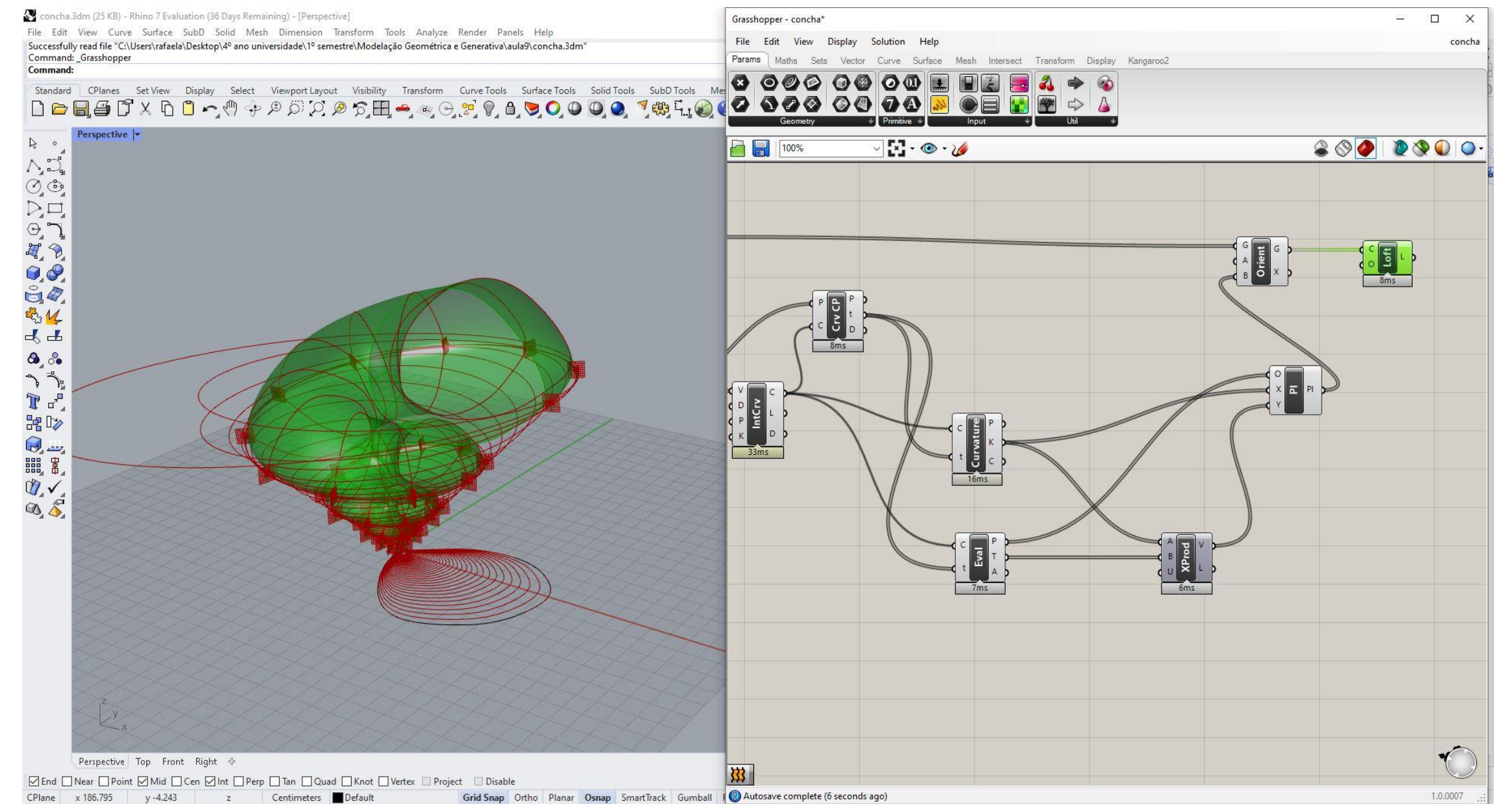
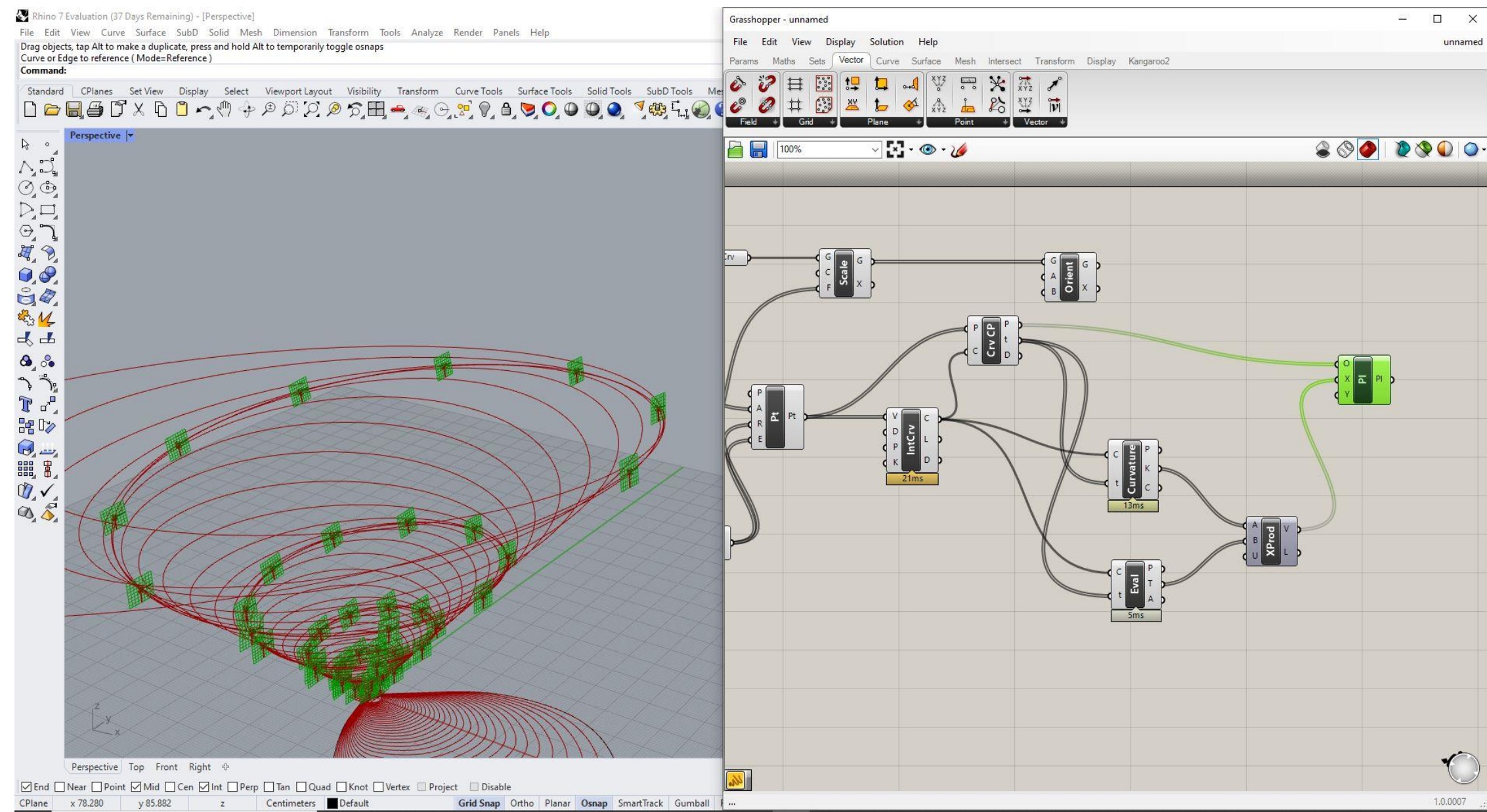

Exerc. 6 – Caramujo no Grasshopper (Processo)

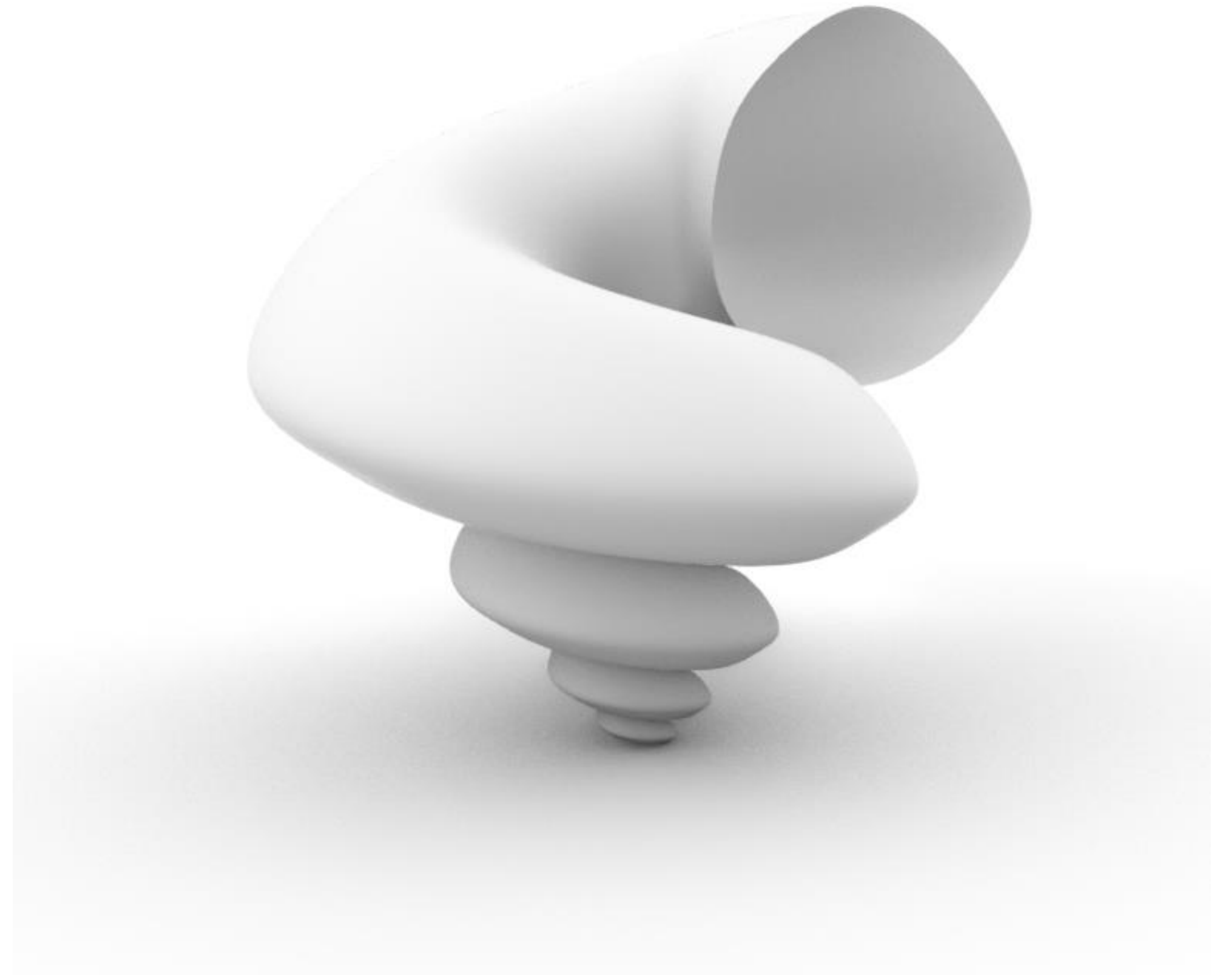

Exerc. 6 – Caramujo no Grasshopper



Exerc. 6 – Caramujo no Grasshopper



Exerc. 7 – CORAIS

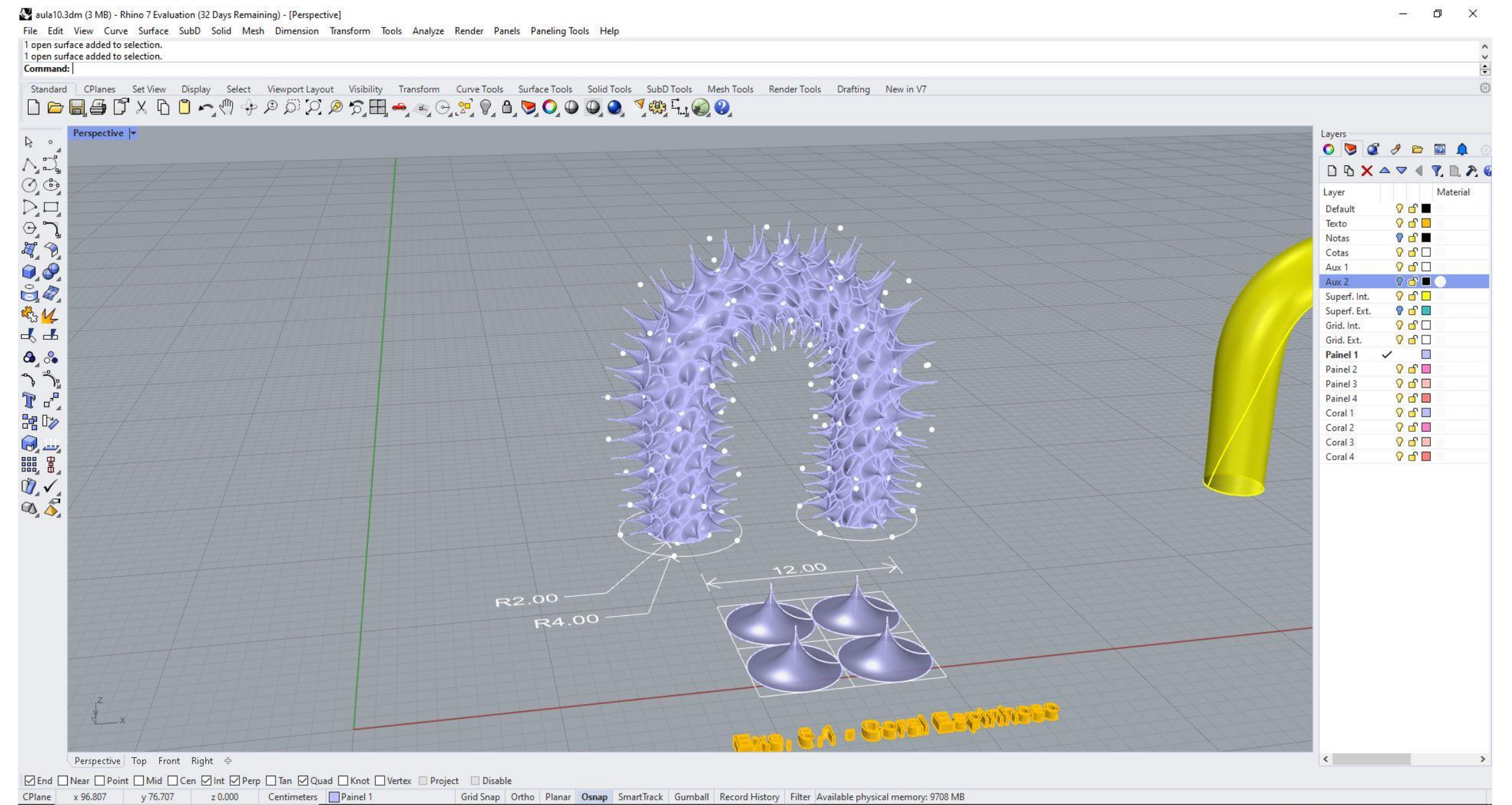
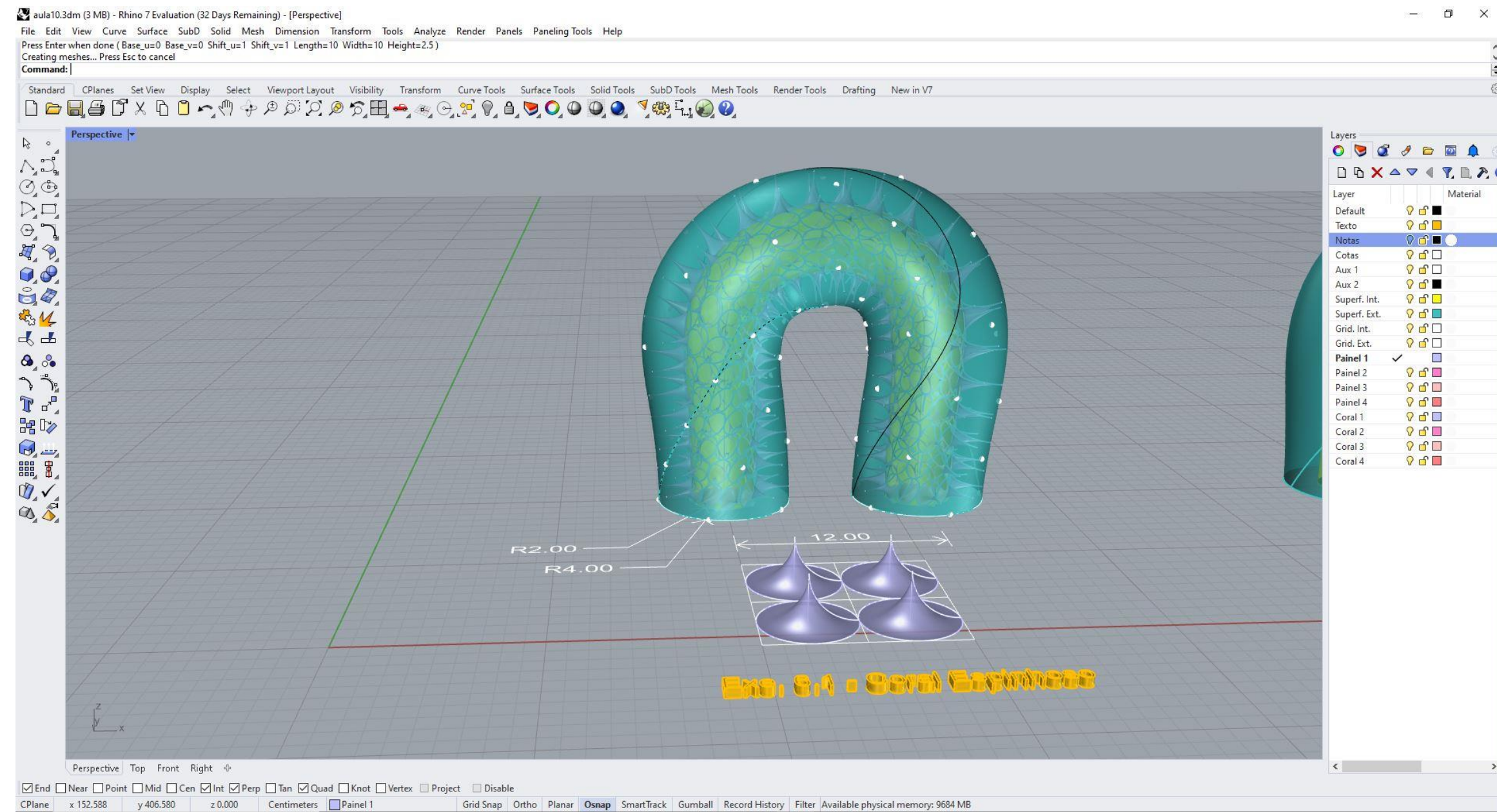

Exerc. 7.1 – Coral Espinhoso (Processo)

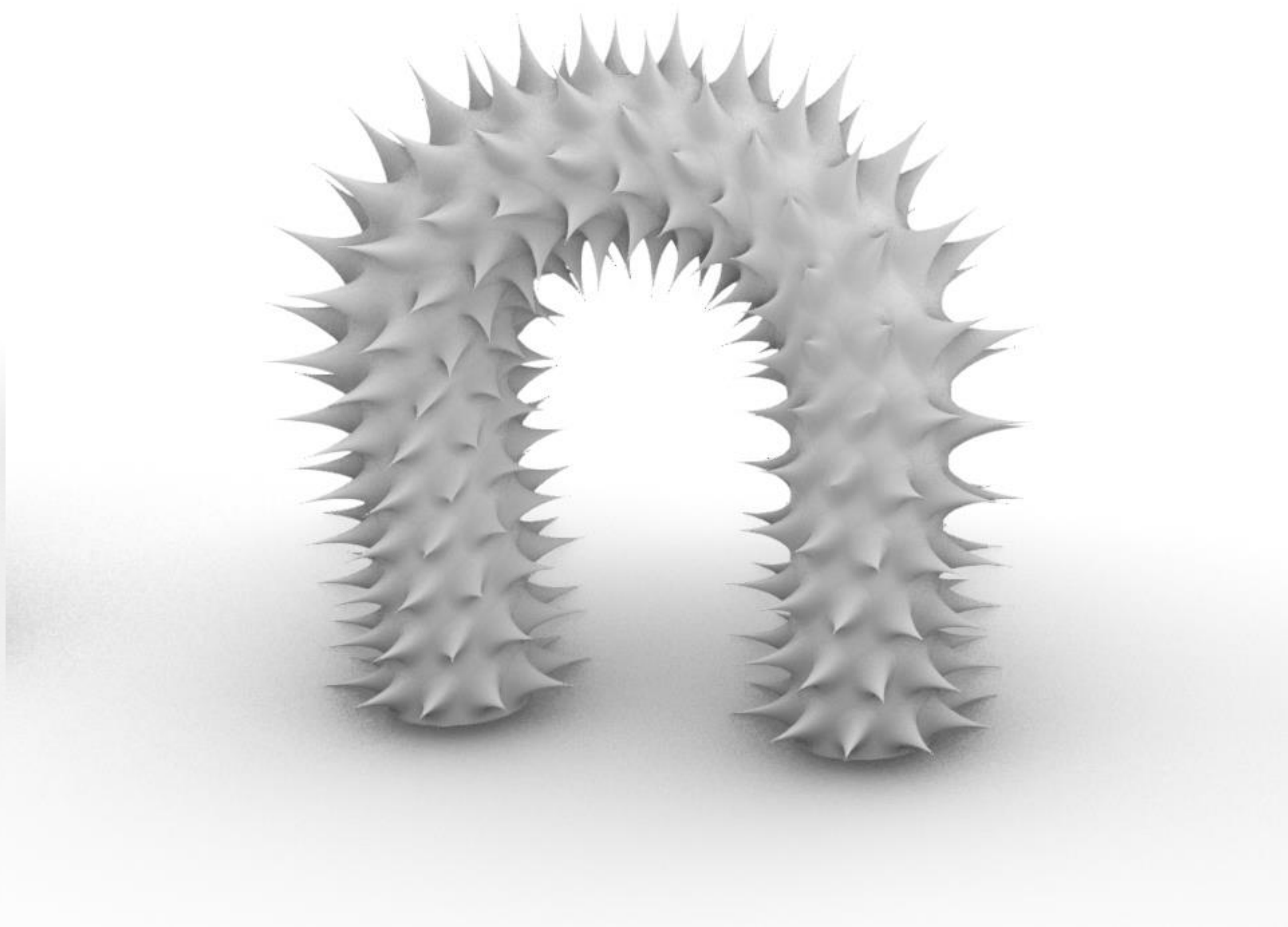
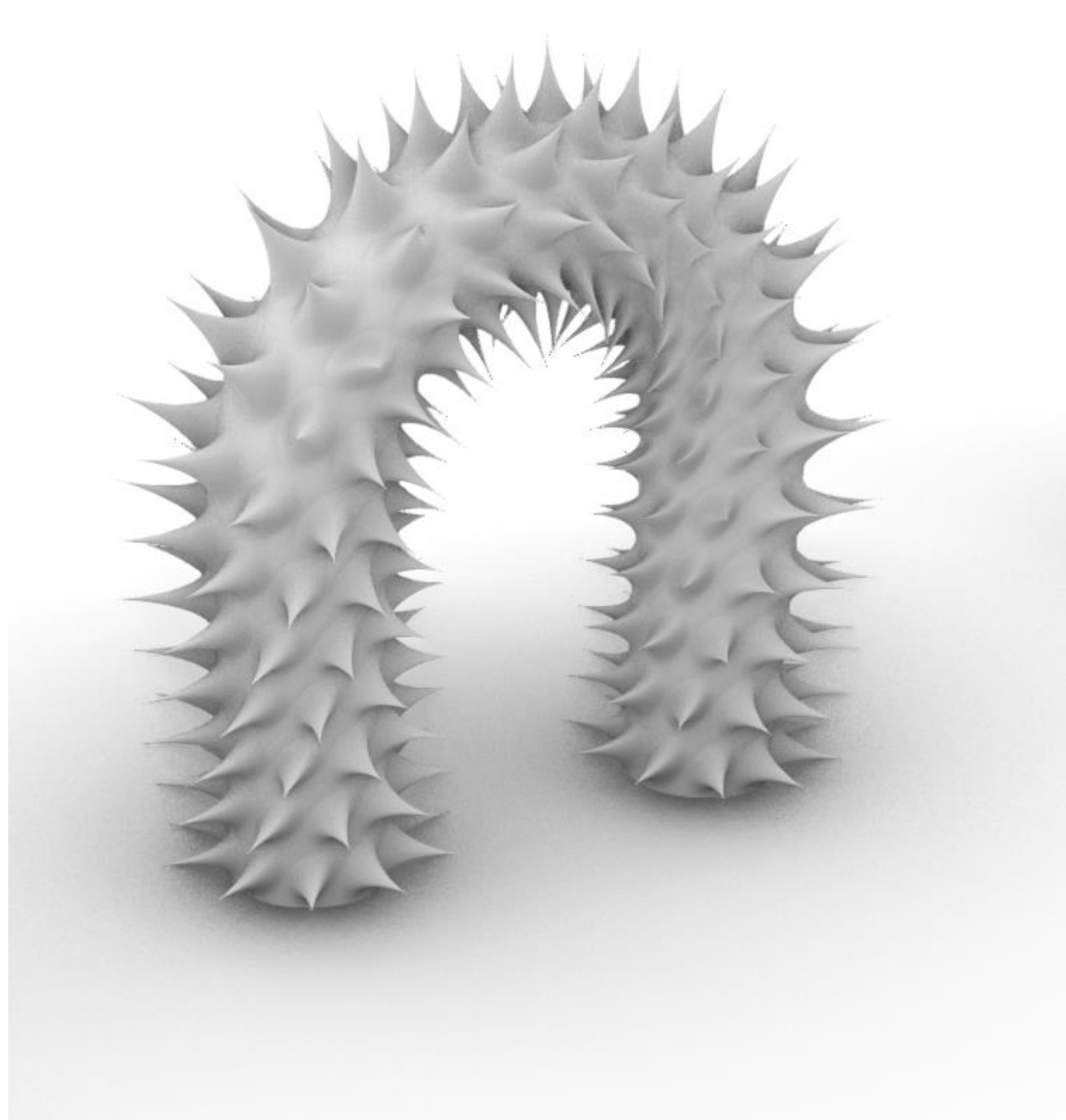

Exerc. 7.1 – Coral Espinhoso

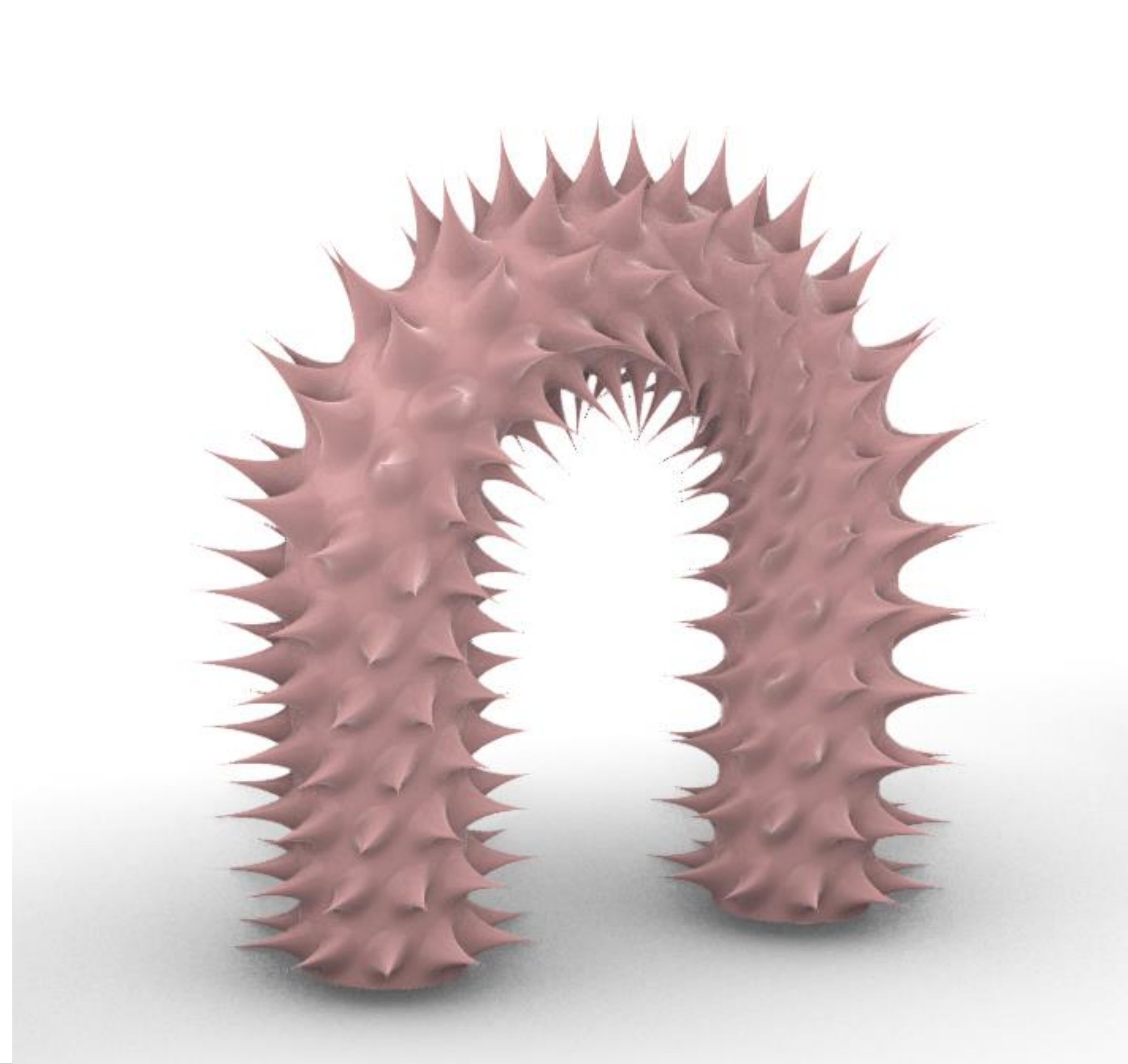

Exerc. 7.1 – Coral Espinhoso

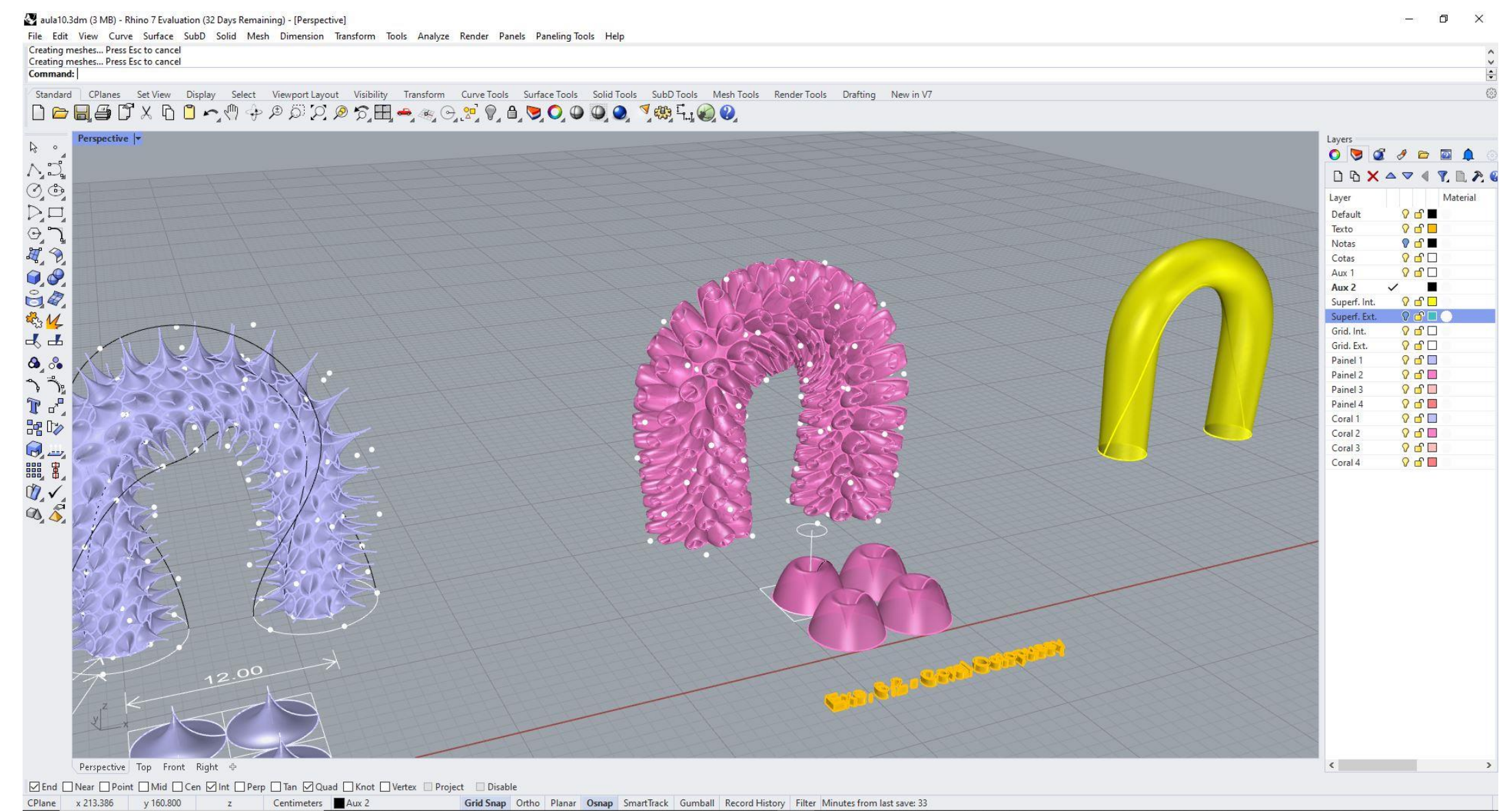
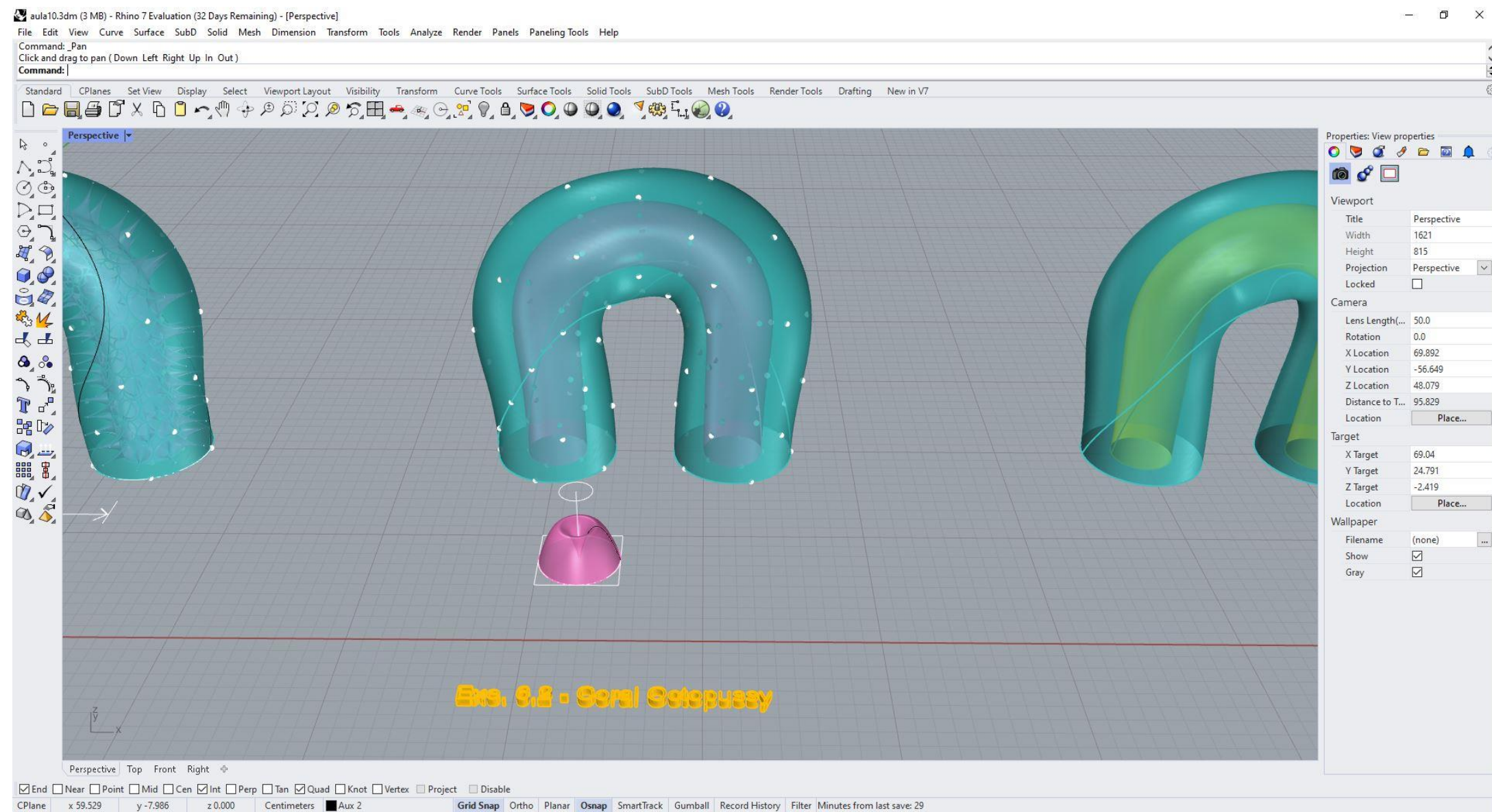

Exerc. 7.2 – Coral 2 (Processo)

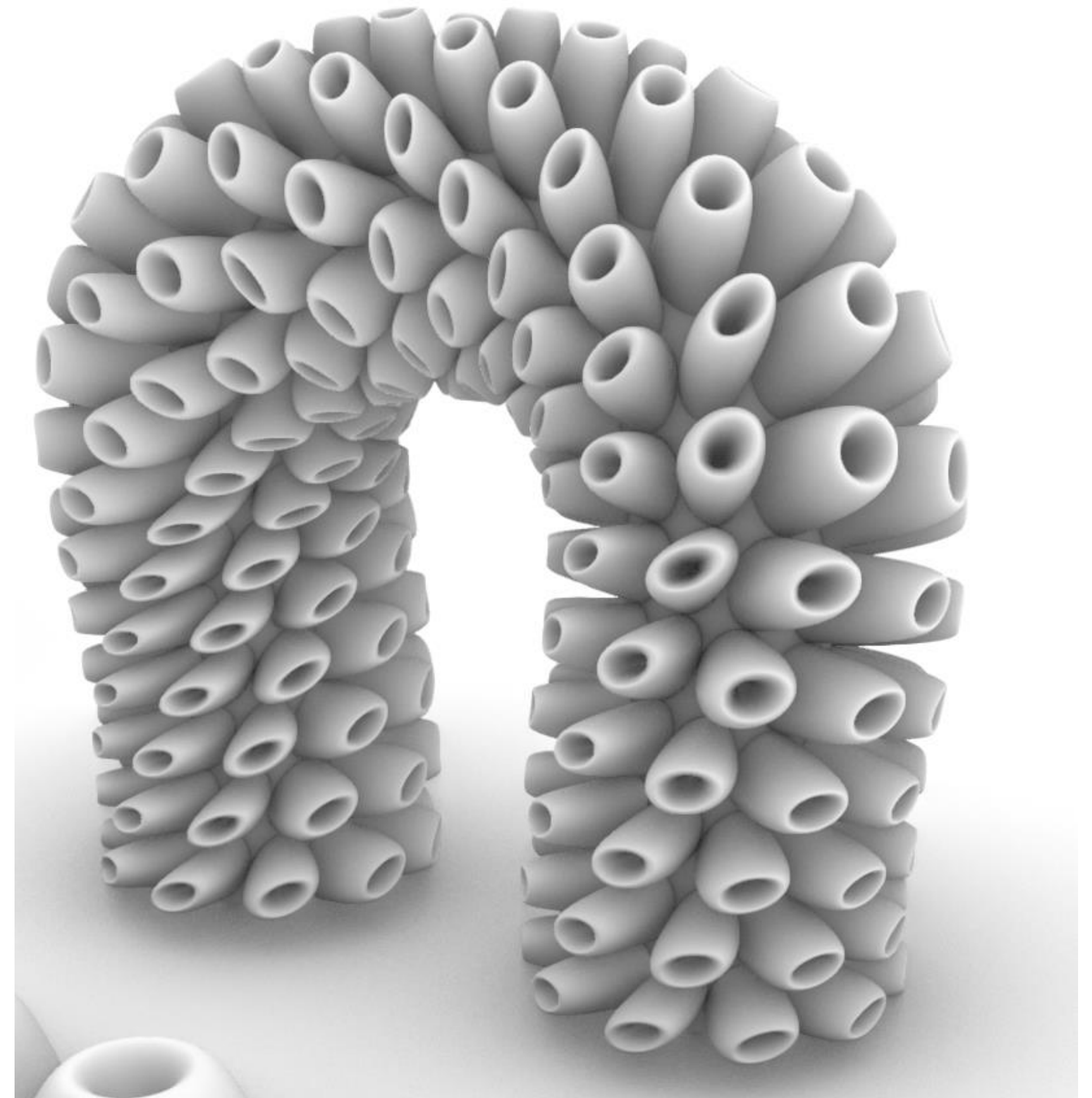
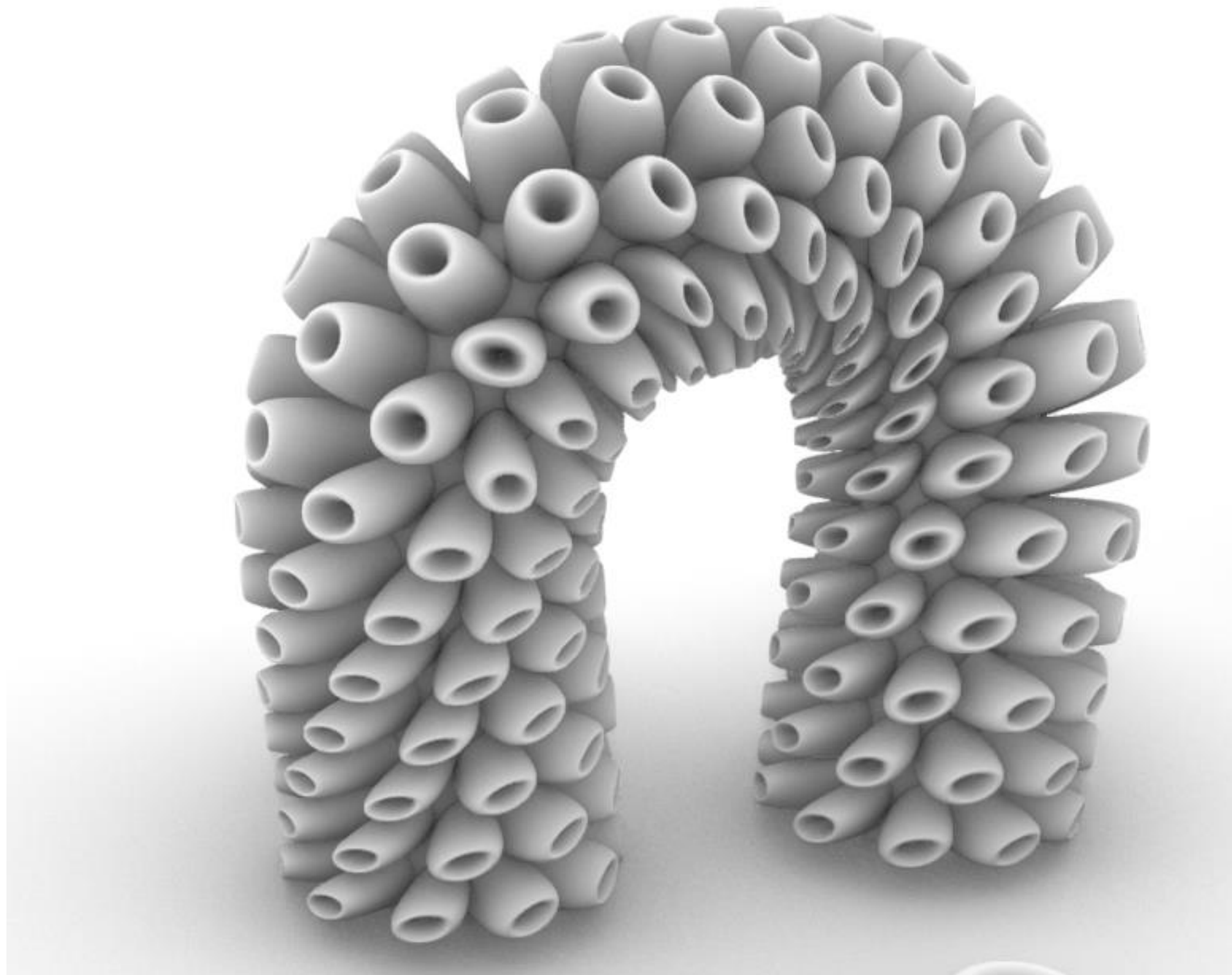

Exerc. 7.2 – Coral 2

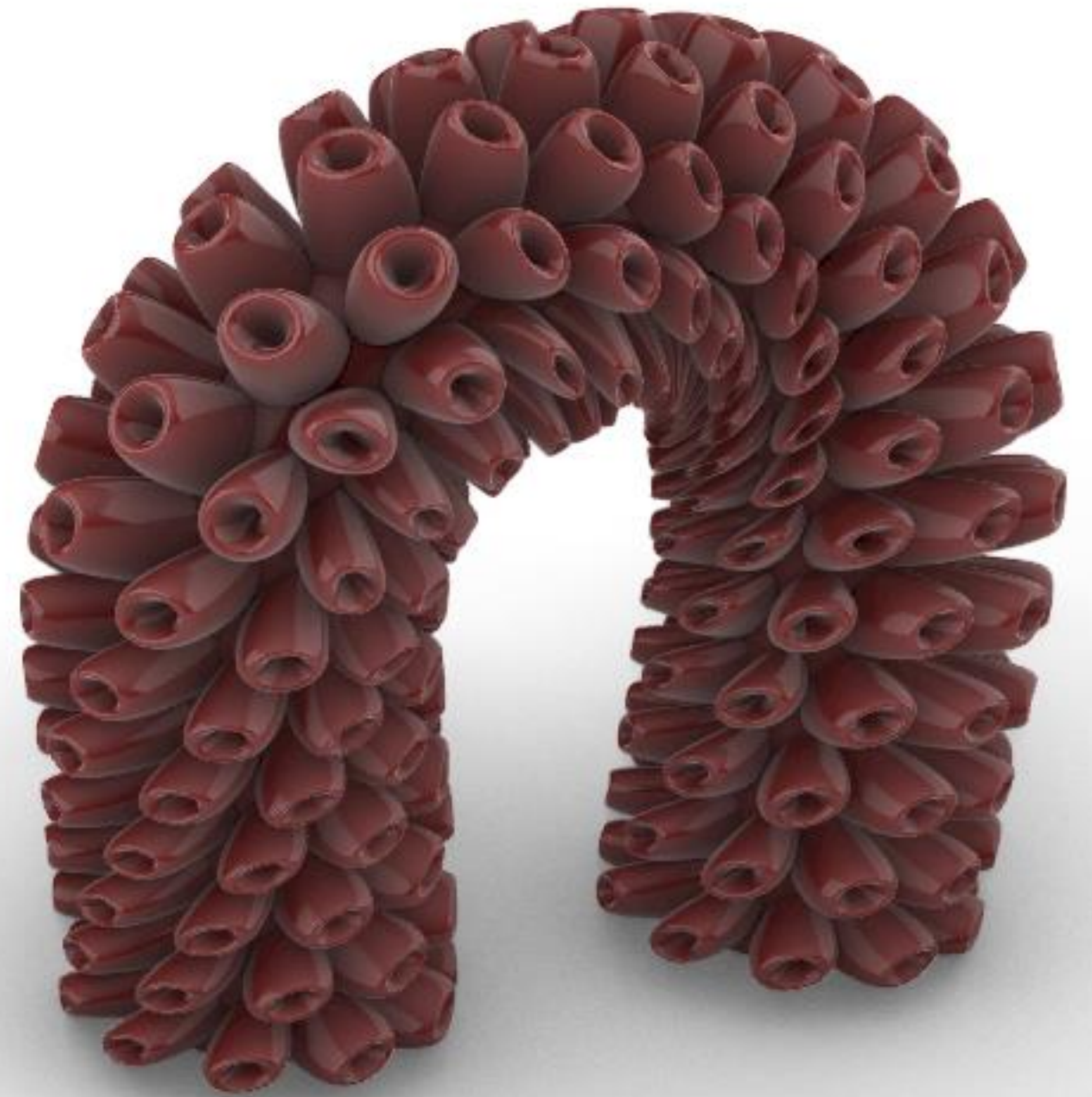

Exerc. 7.2 – Coral 2

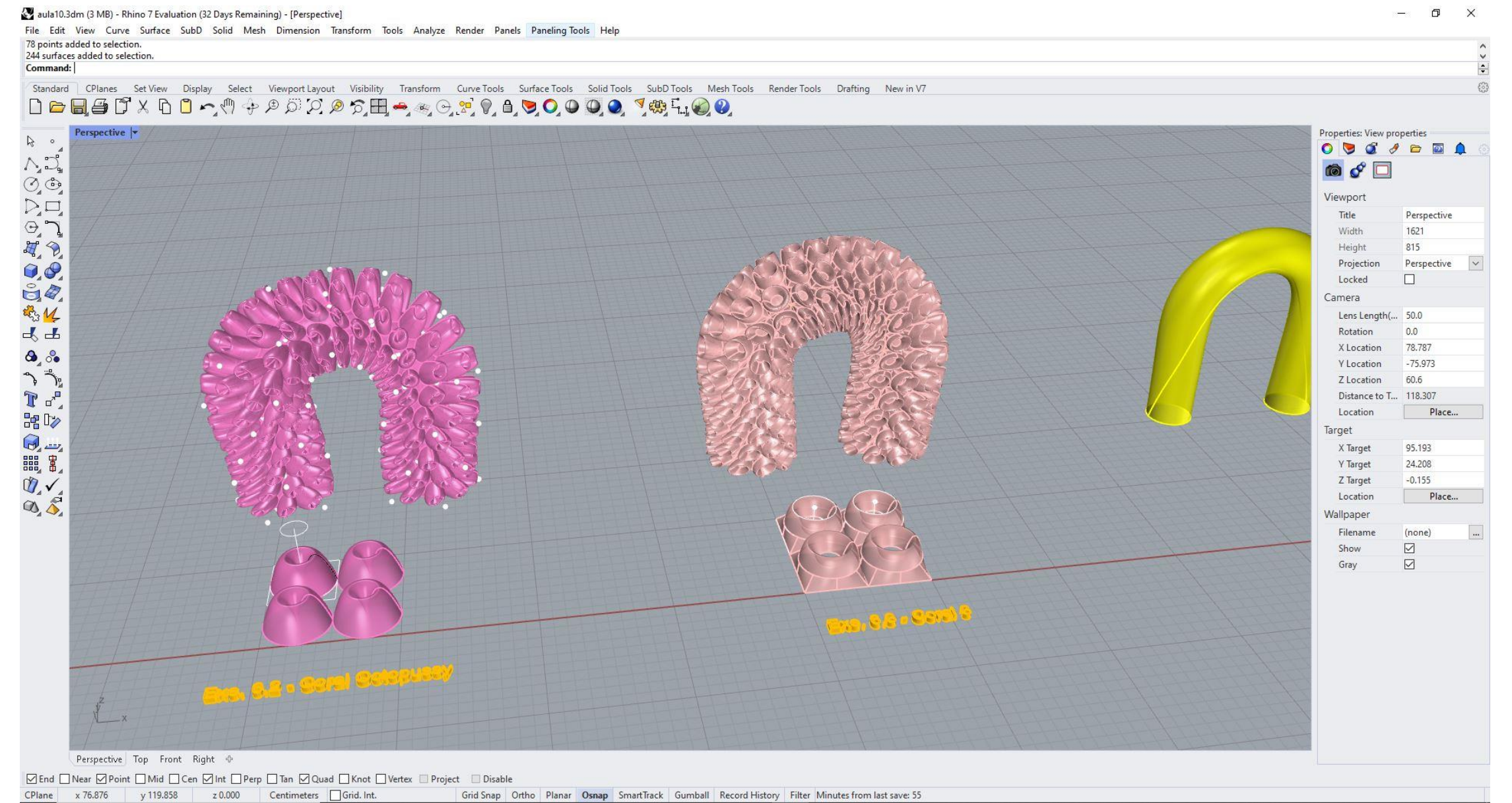
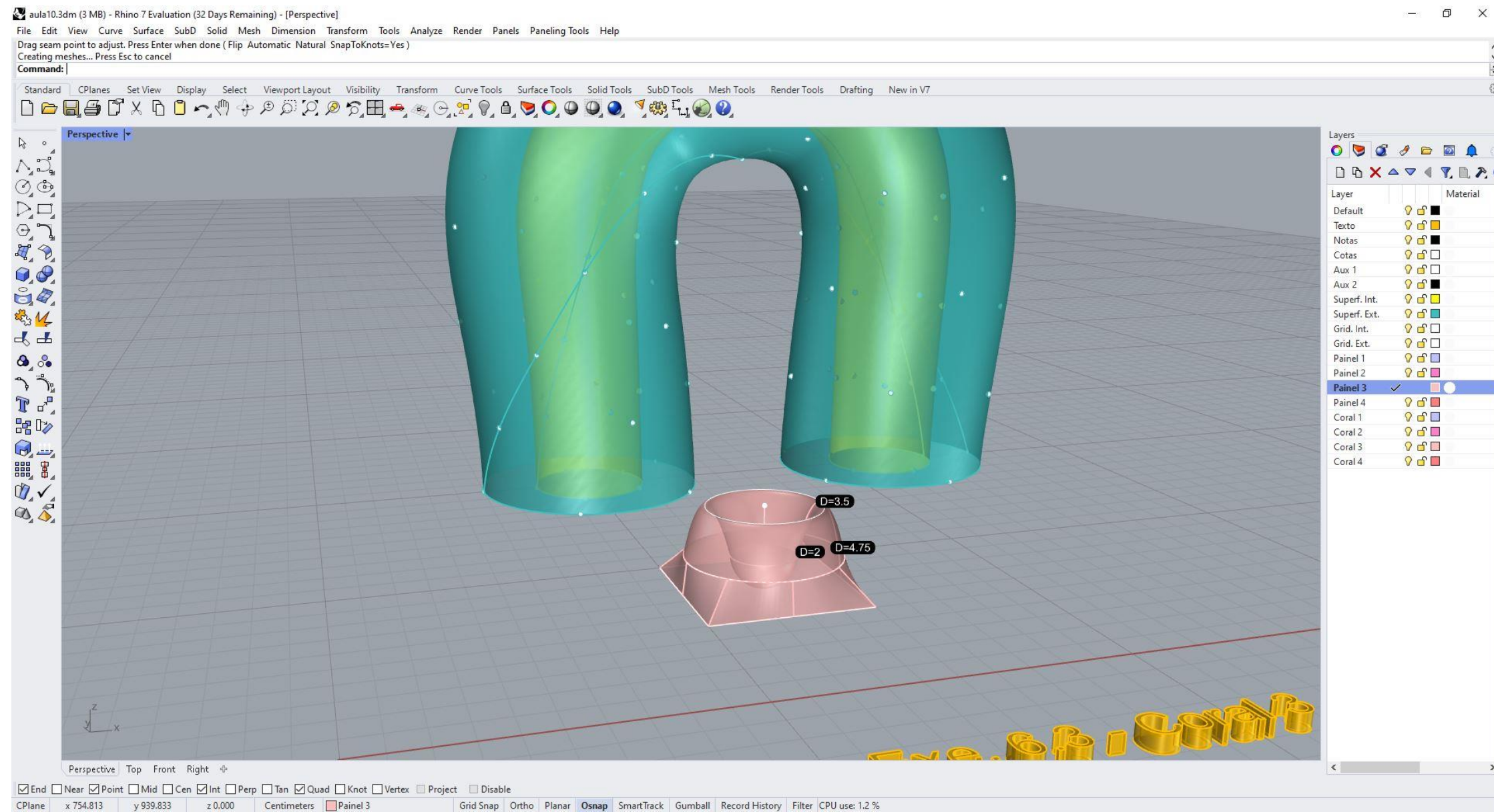

Exerc. 7.3 – Coral 3 (Processso)

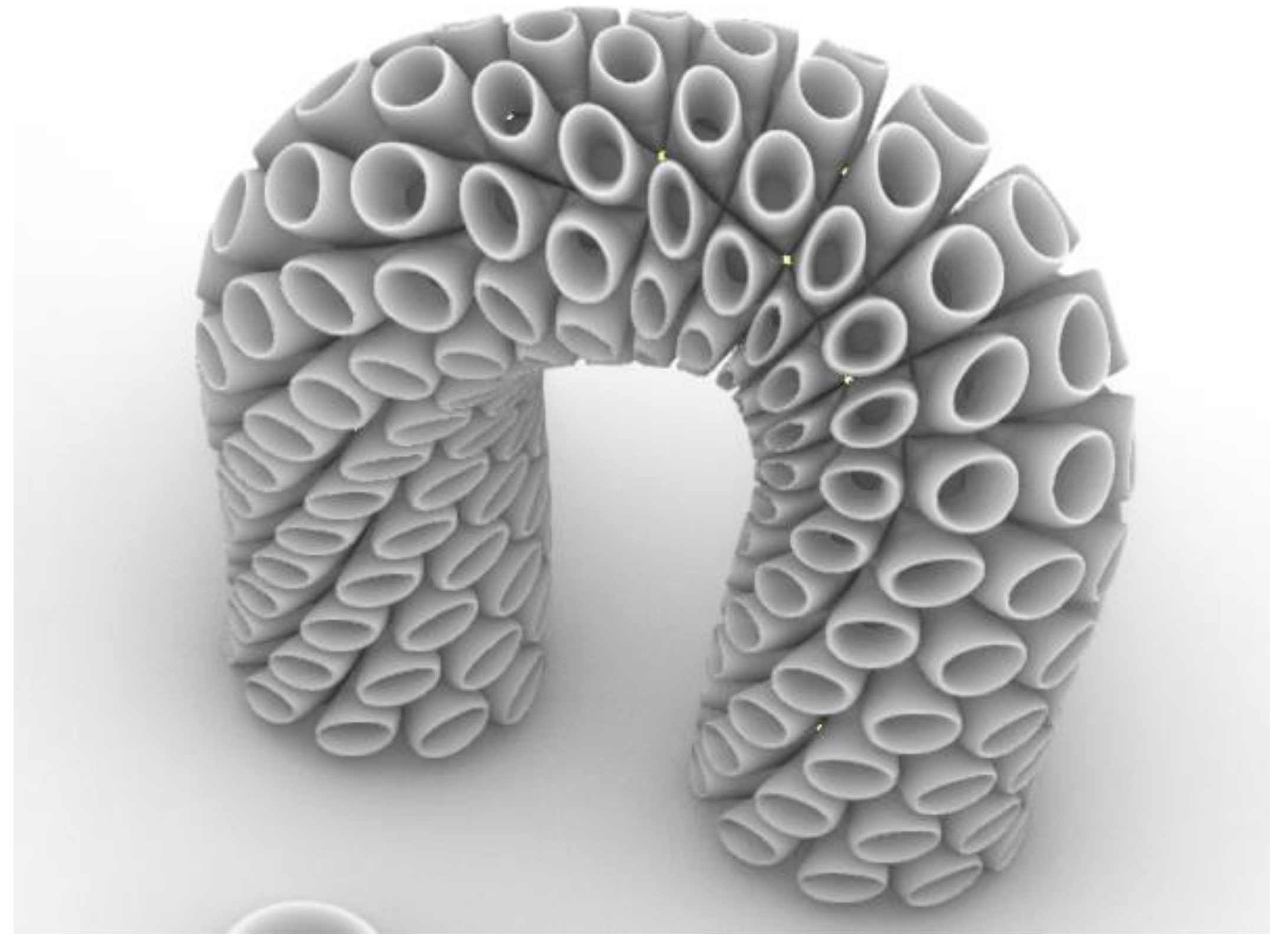
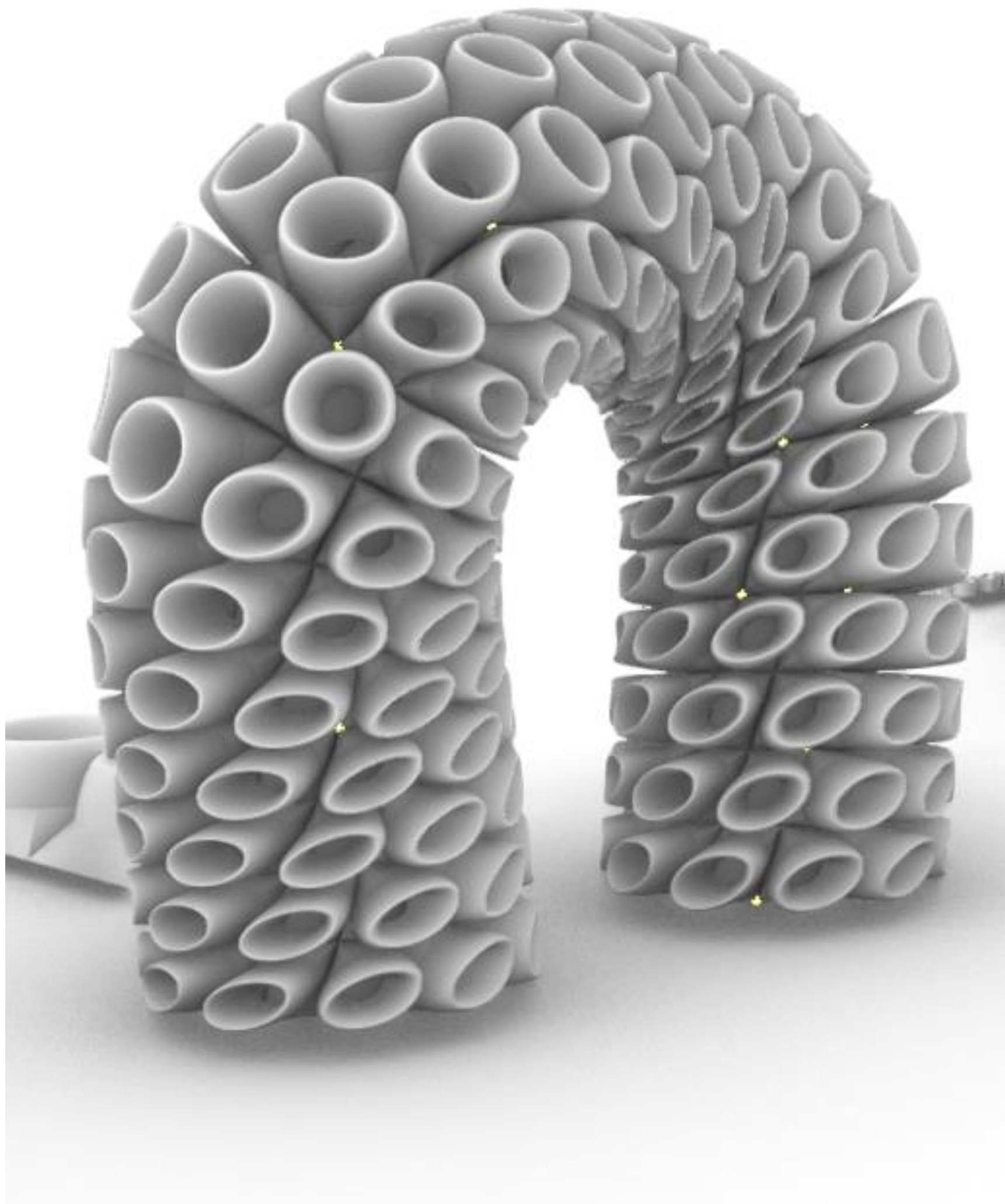

Exerc. 7.3 – Coral 3

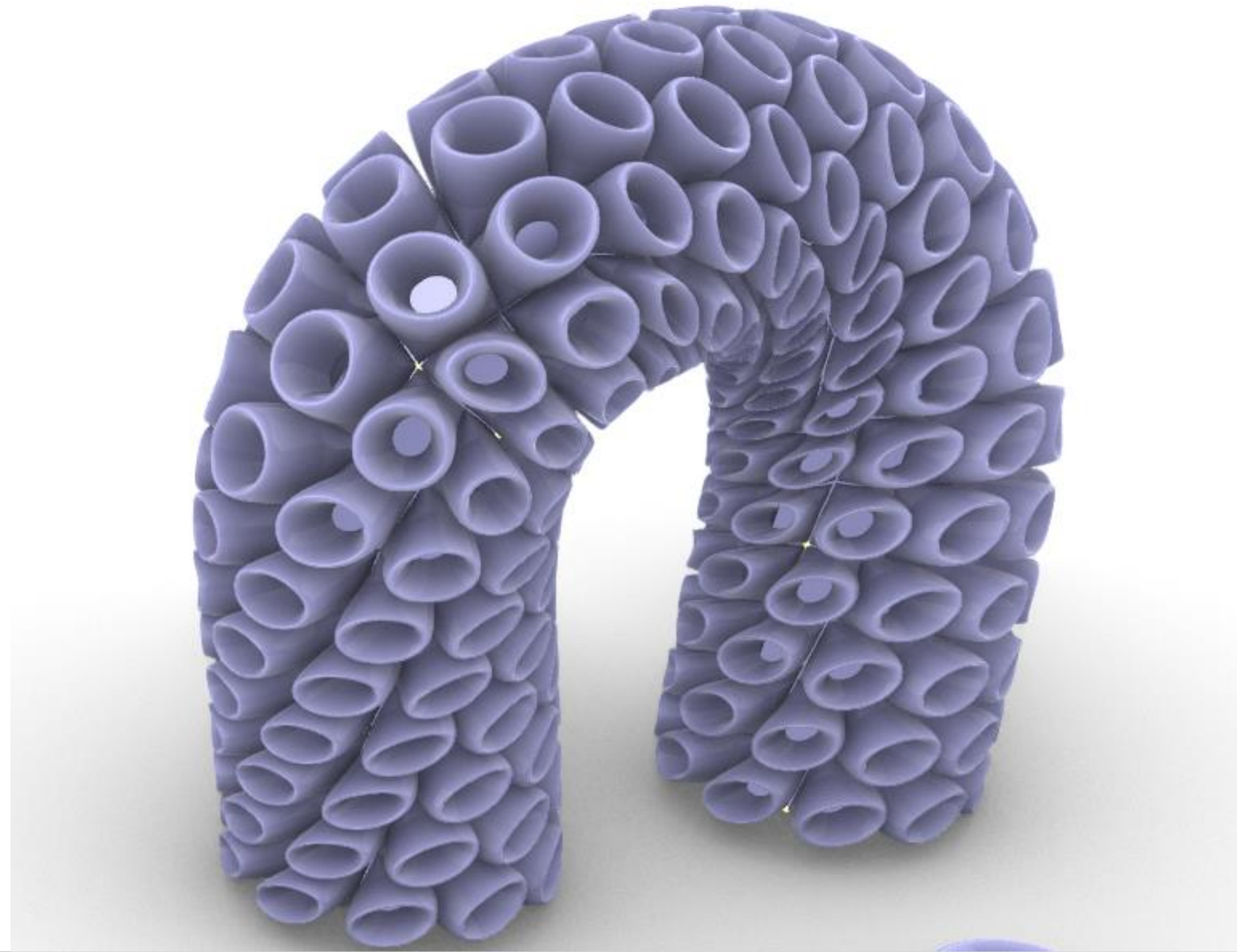

Exerc. 7.3 – Coral 3

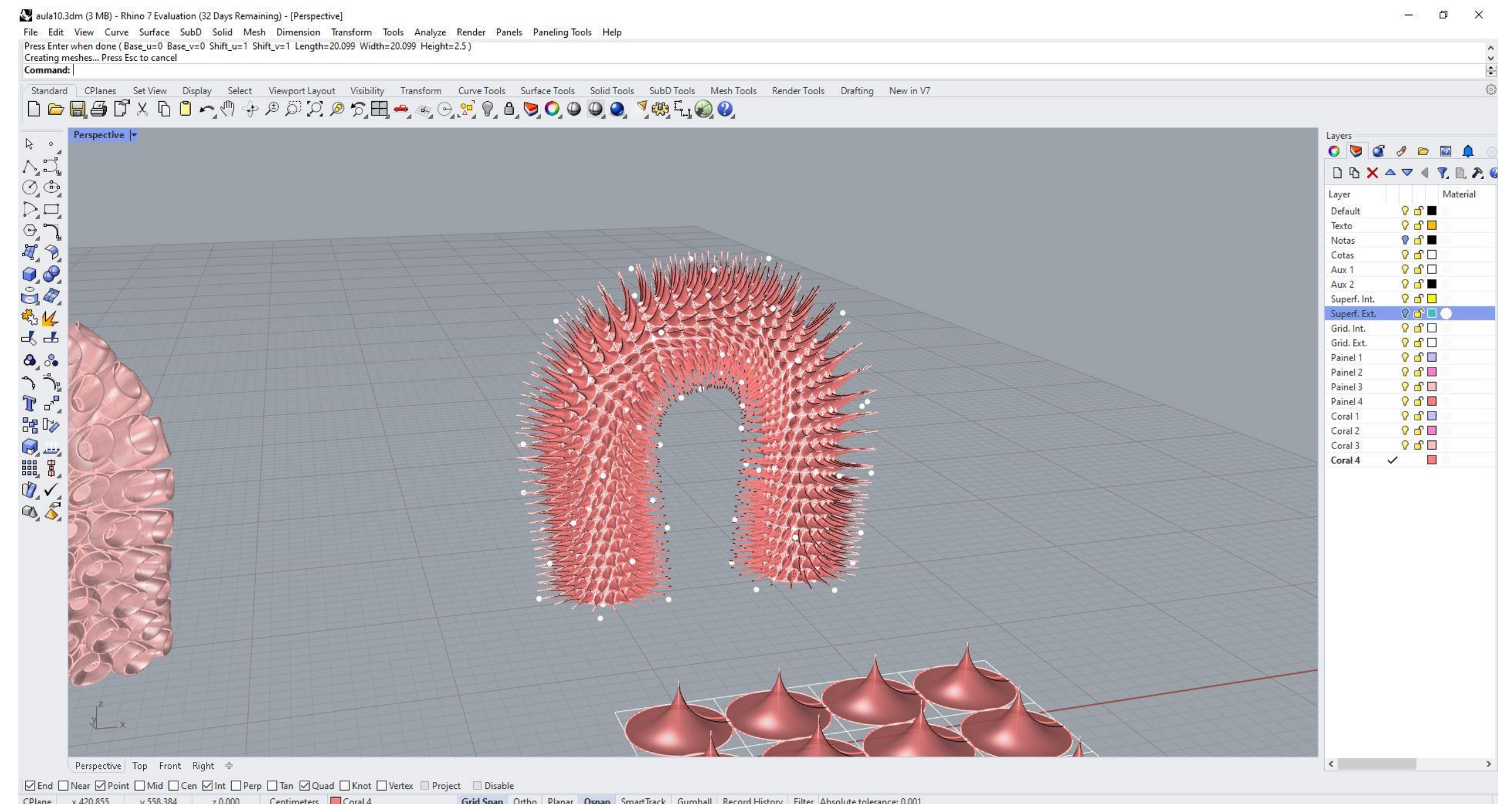
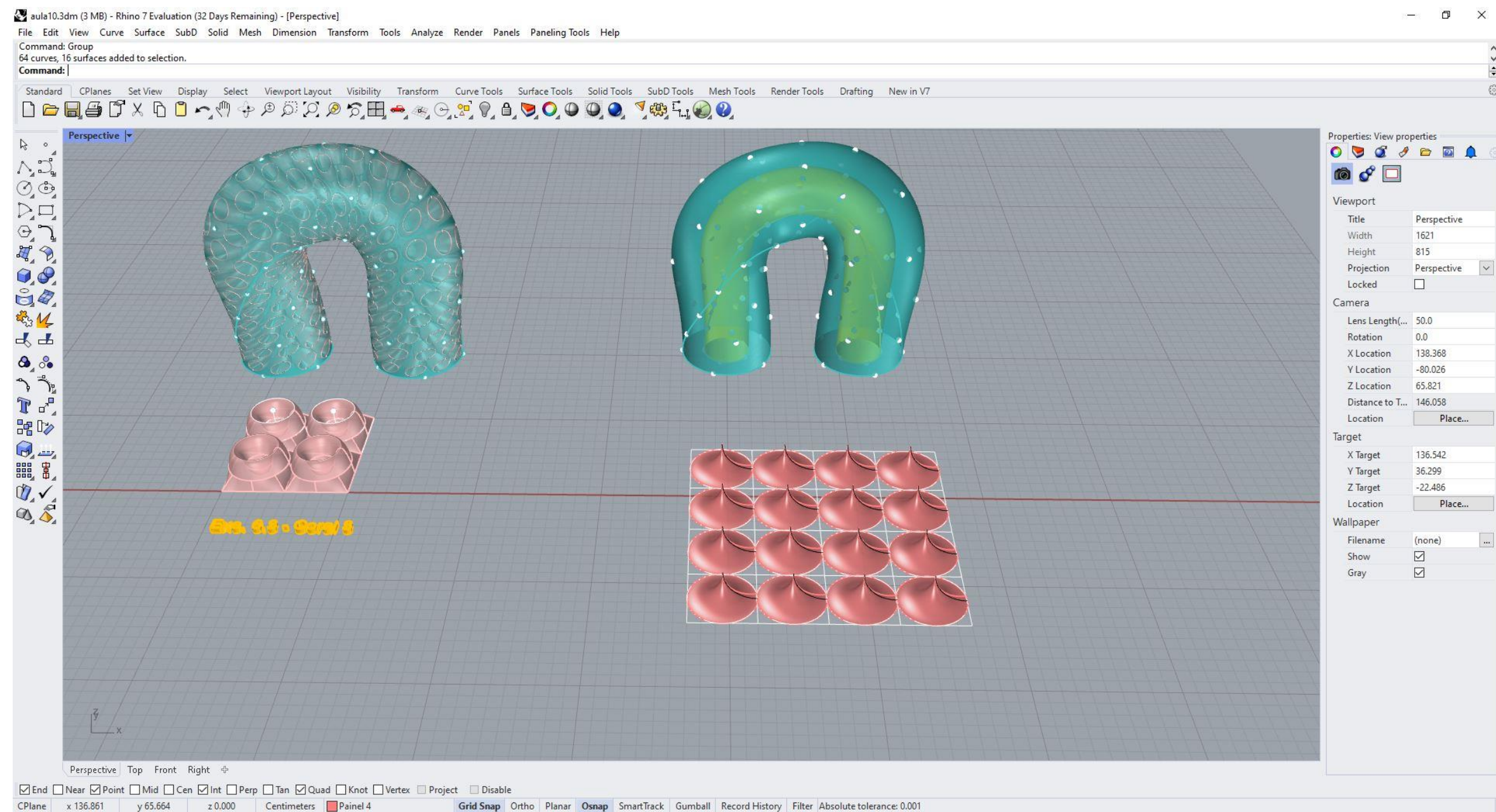

Exerc. 7.4 – Coral 4 (Processso)

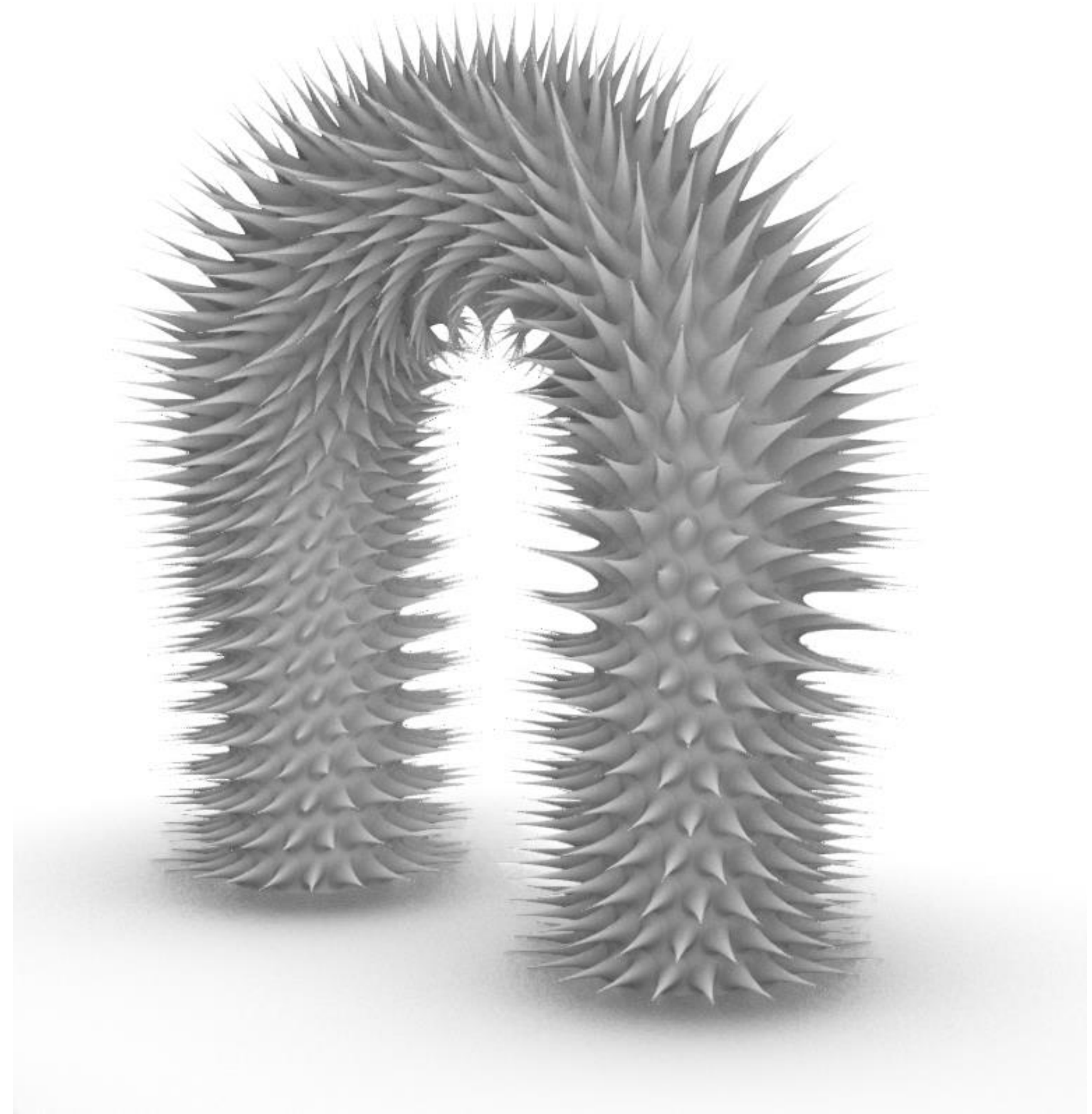
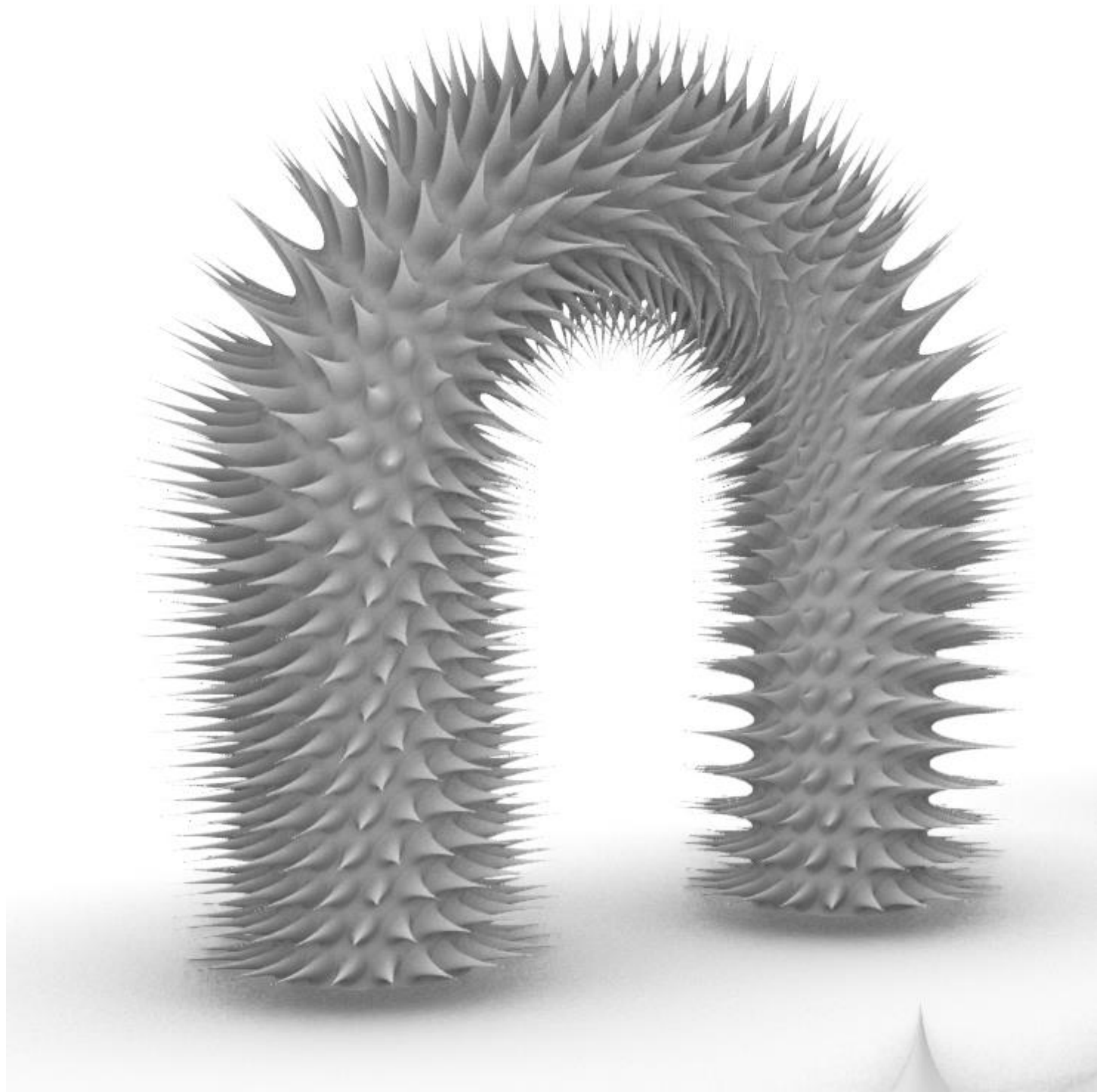

Exerc. 7.4 – Coral 4 (Espinheiro)

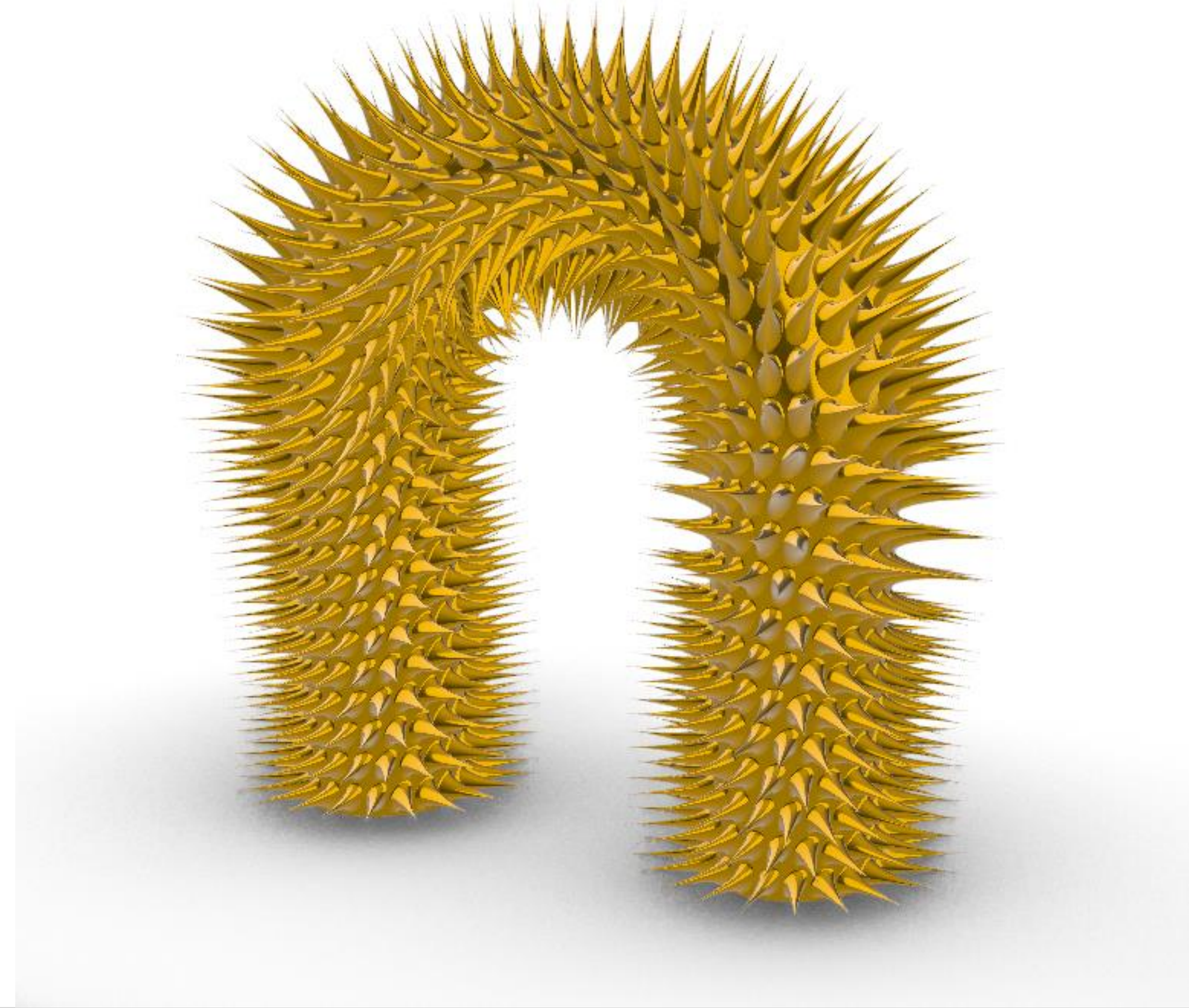

Exerc. 7.4 – Coral 4 (Espinhoso)



Exerc. 8 – ANÉMONA

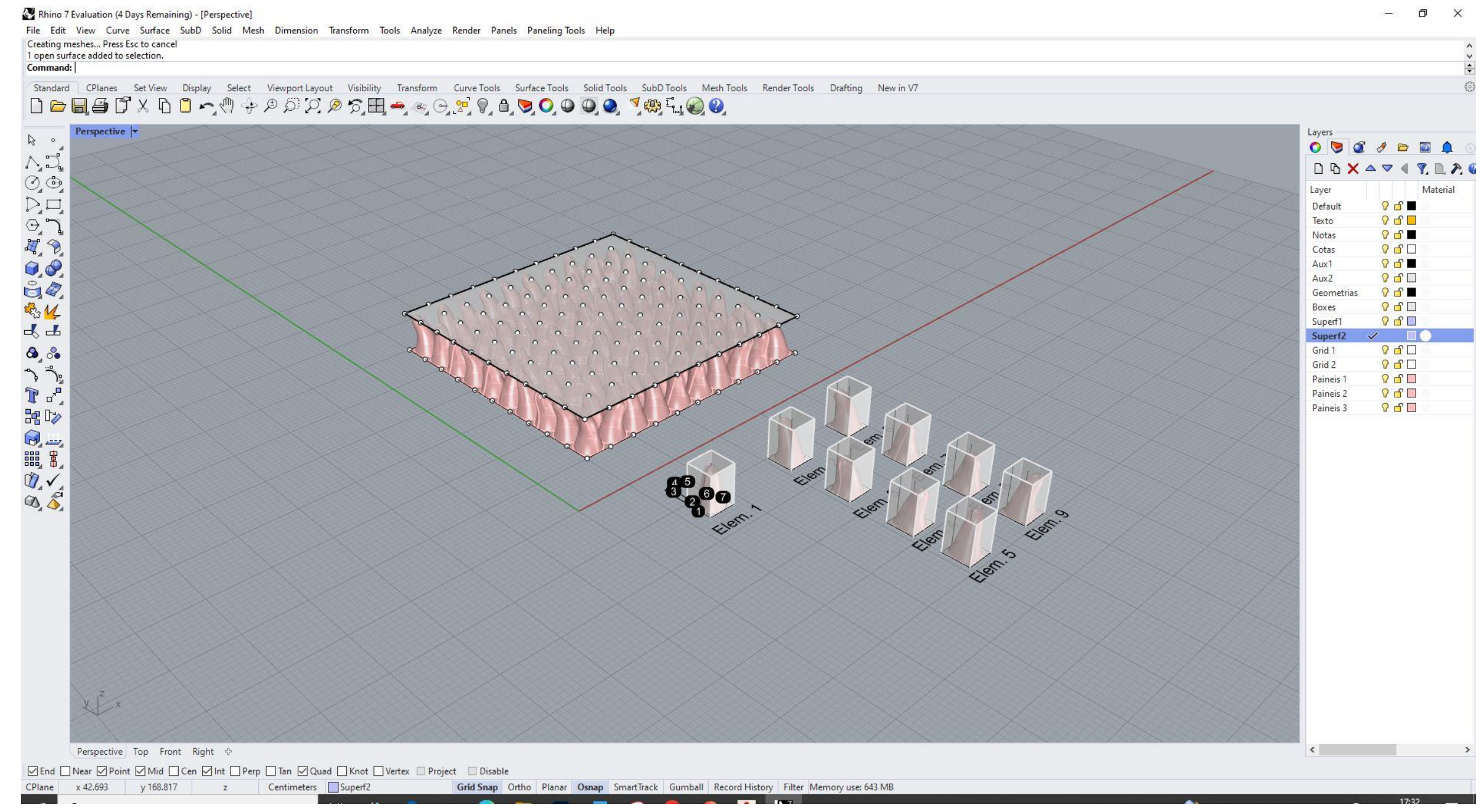
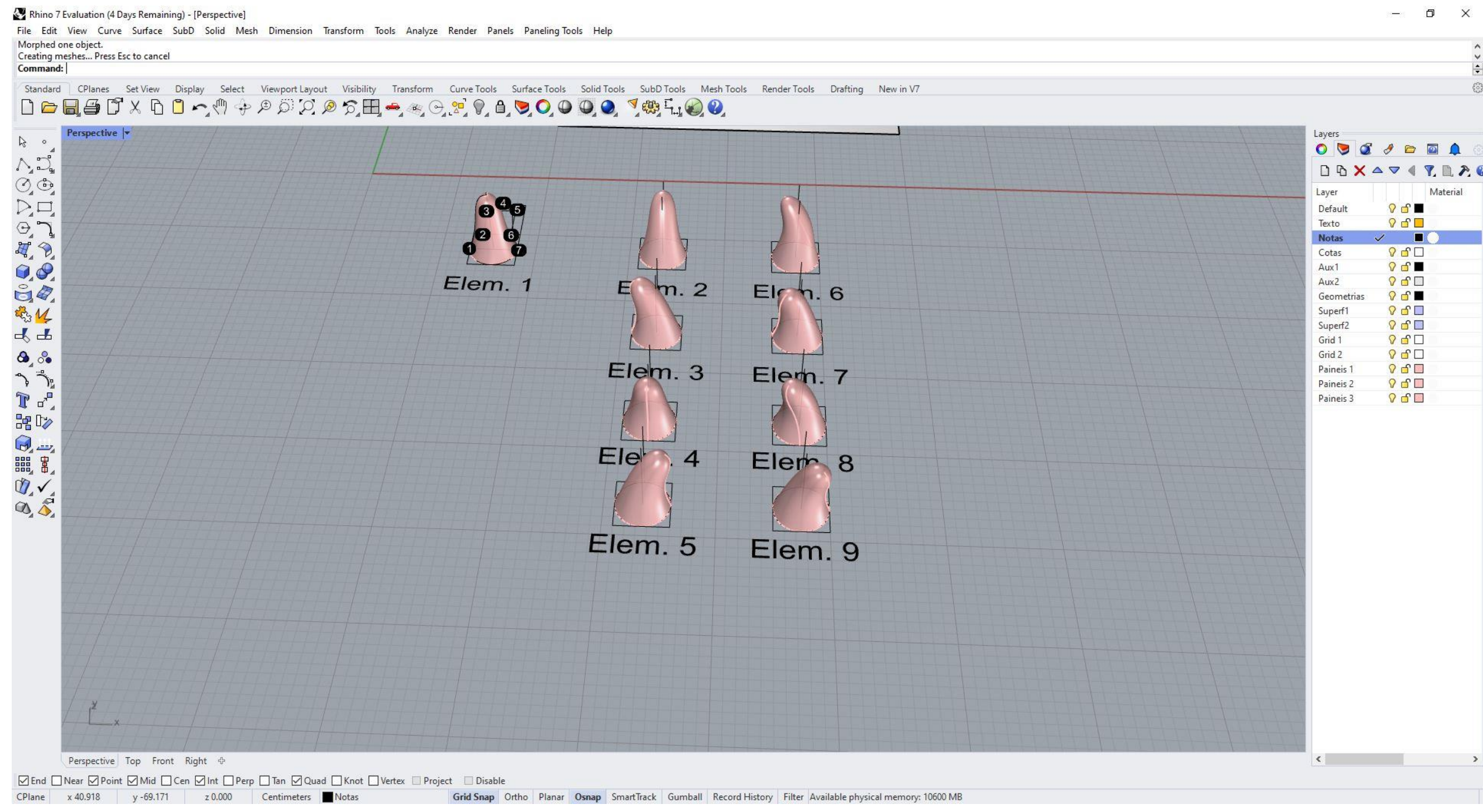

Exerc. 8 – Anémoma (Processo)

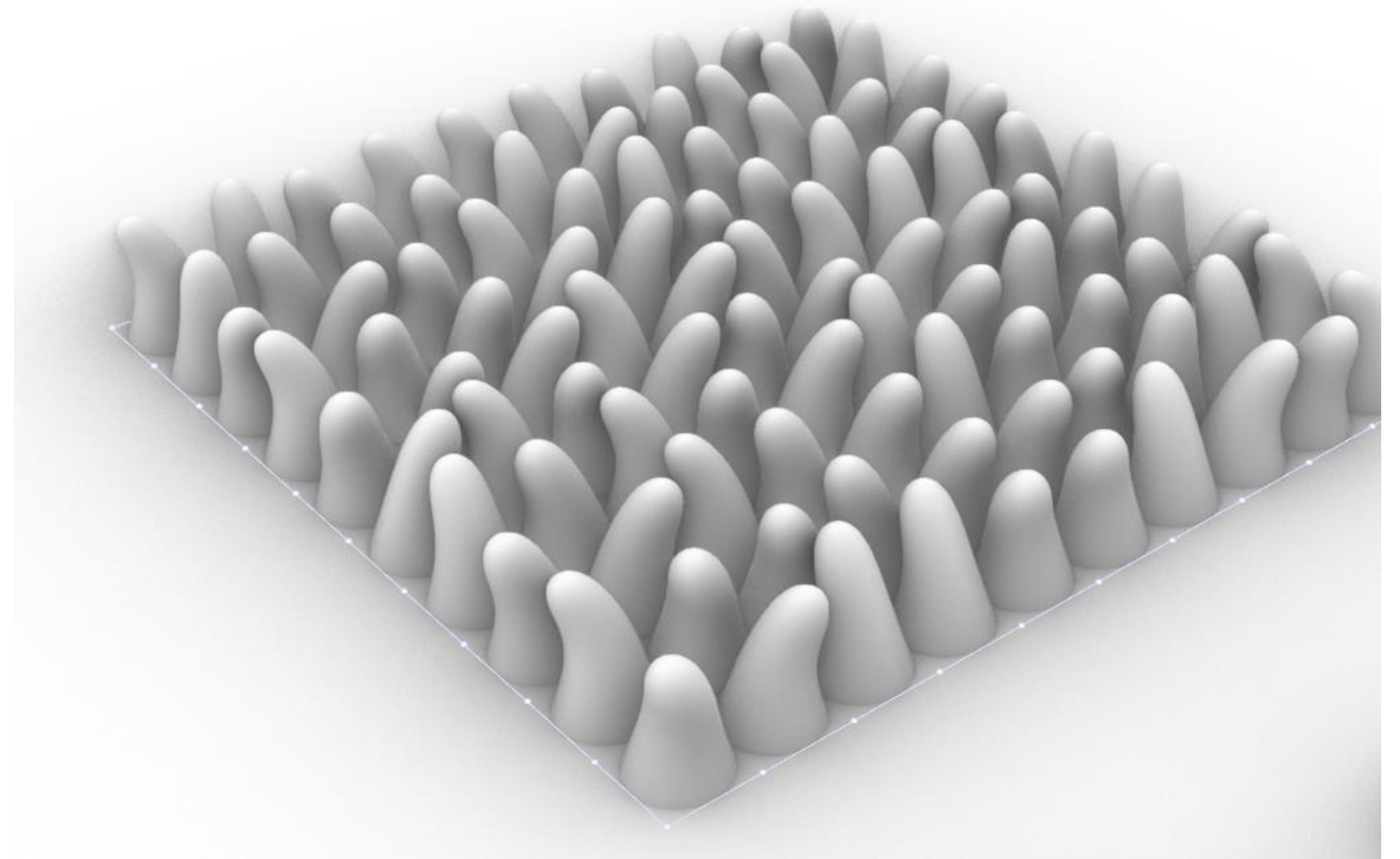
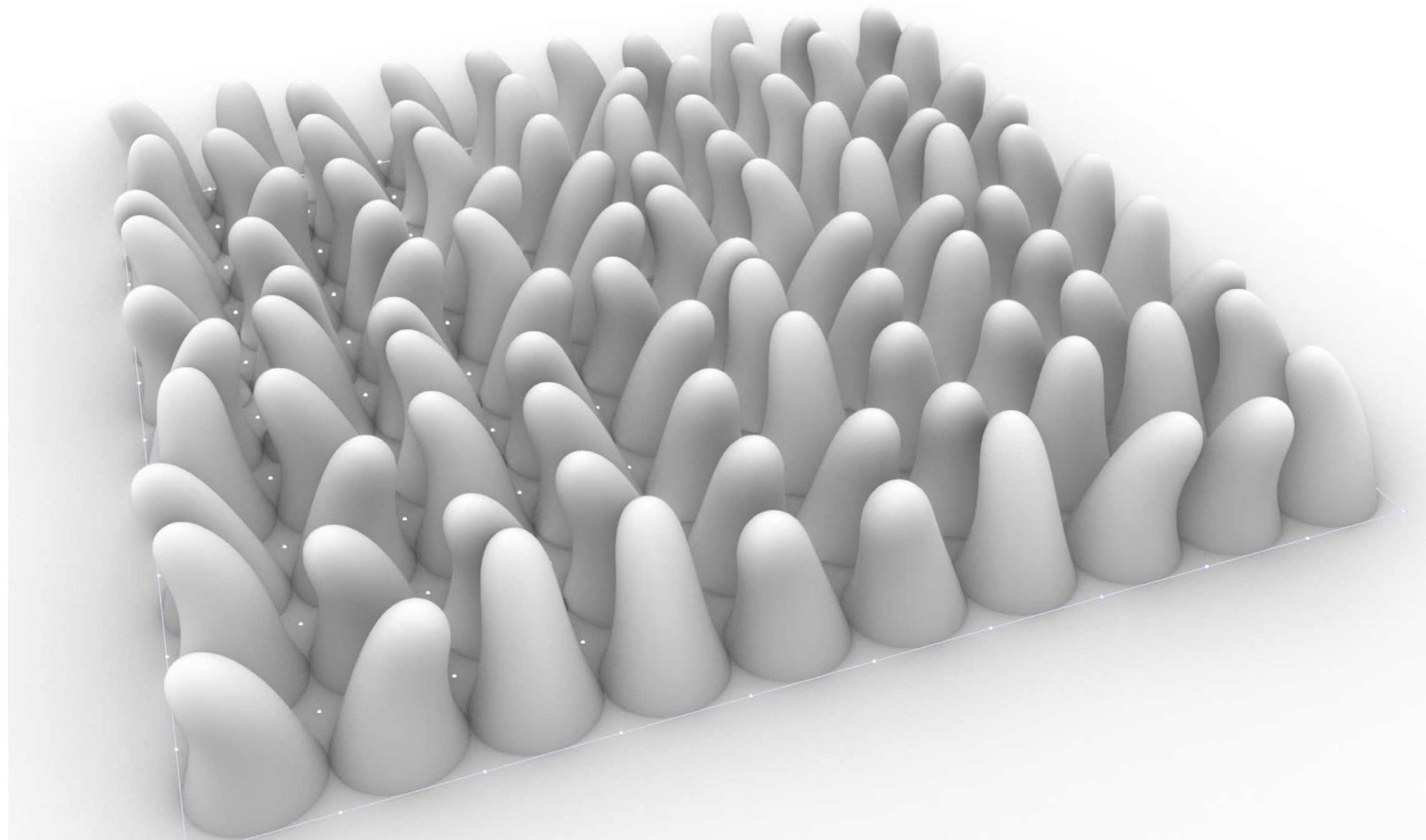

Exerc. 8 – Anémoma

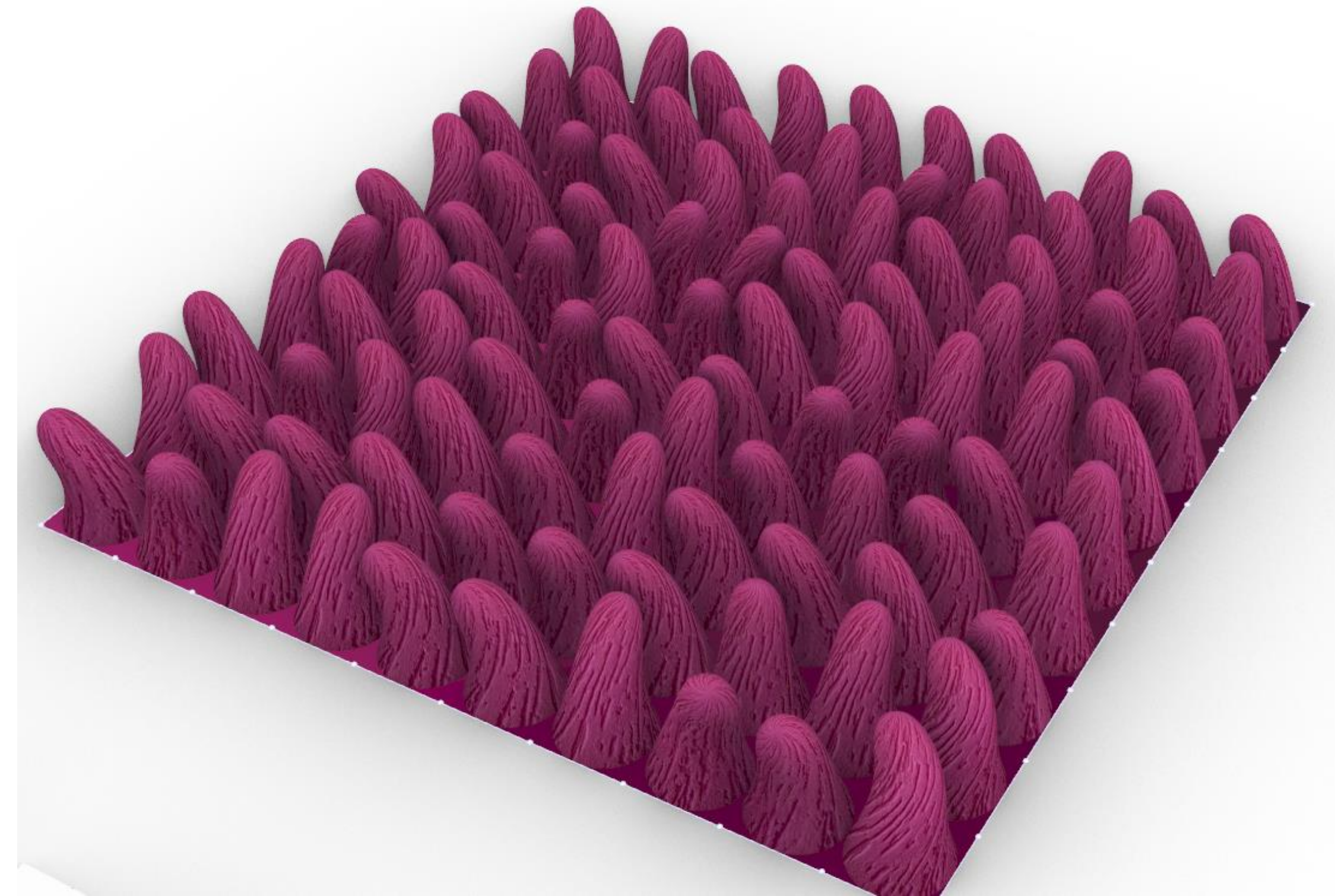
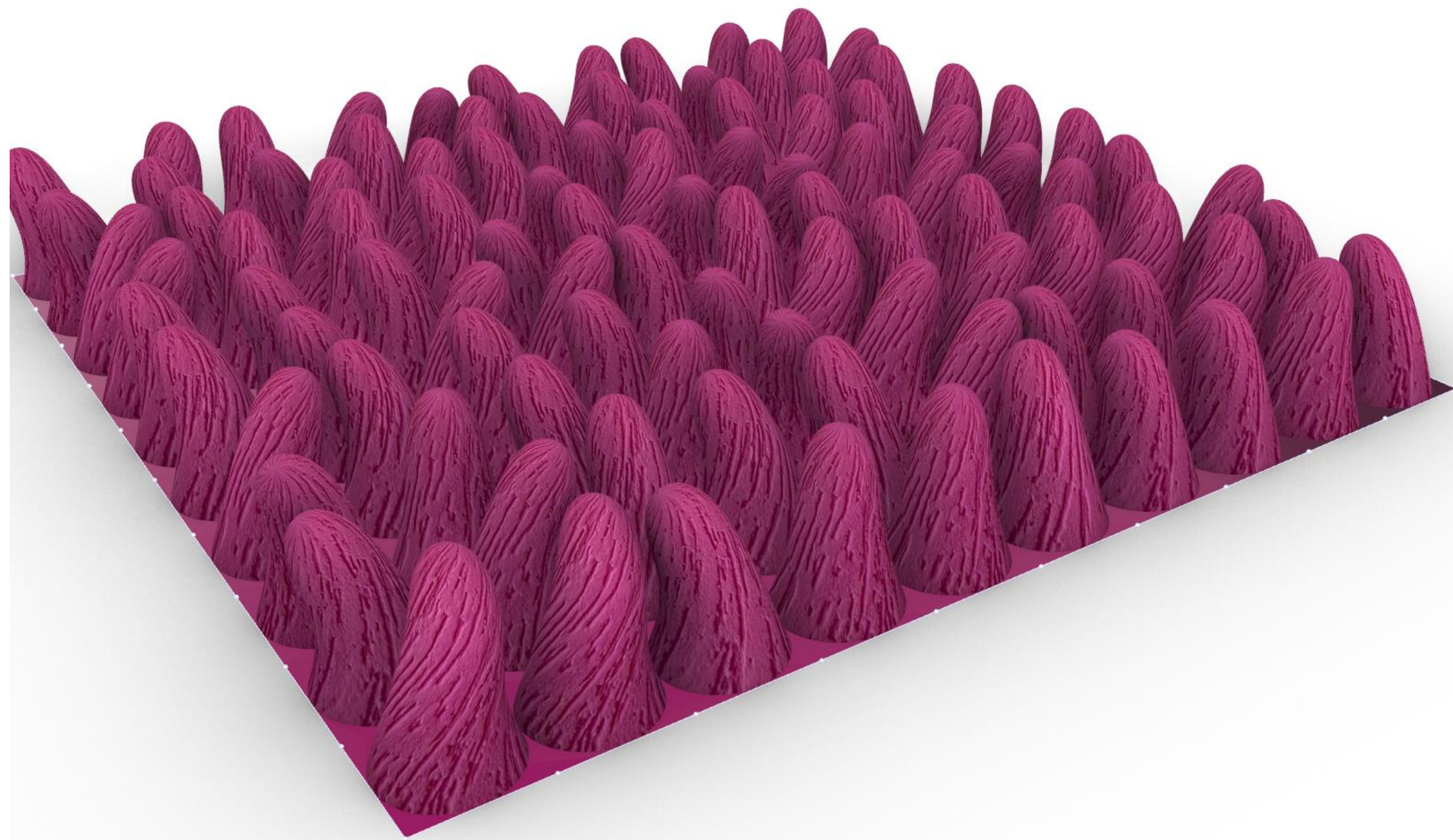

Exerc. 8 – Anémoma



Exerc. 9 – ABÓBADAS

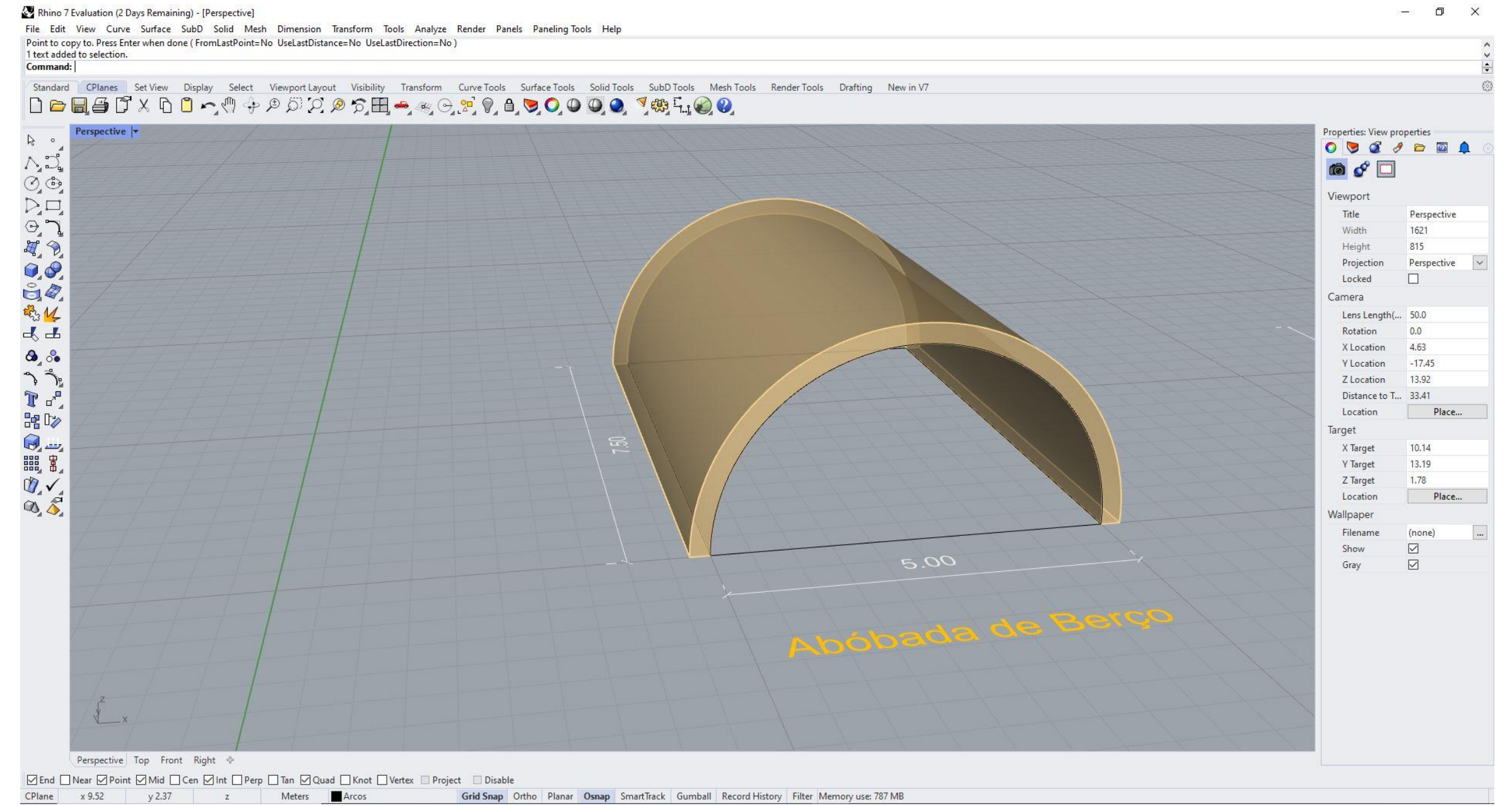
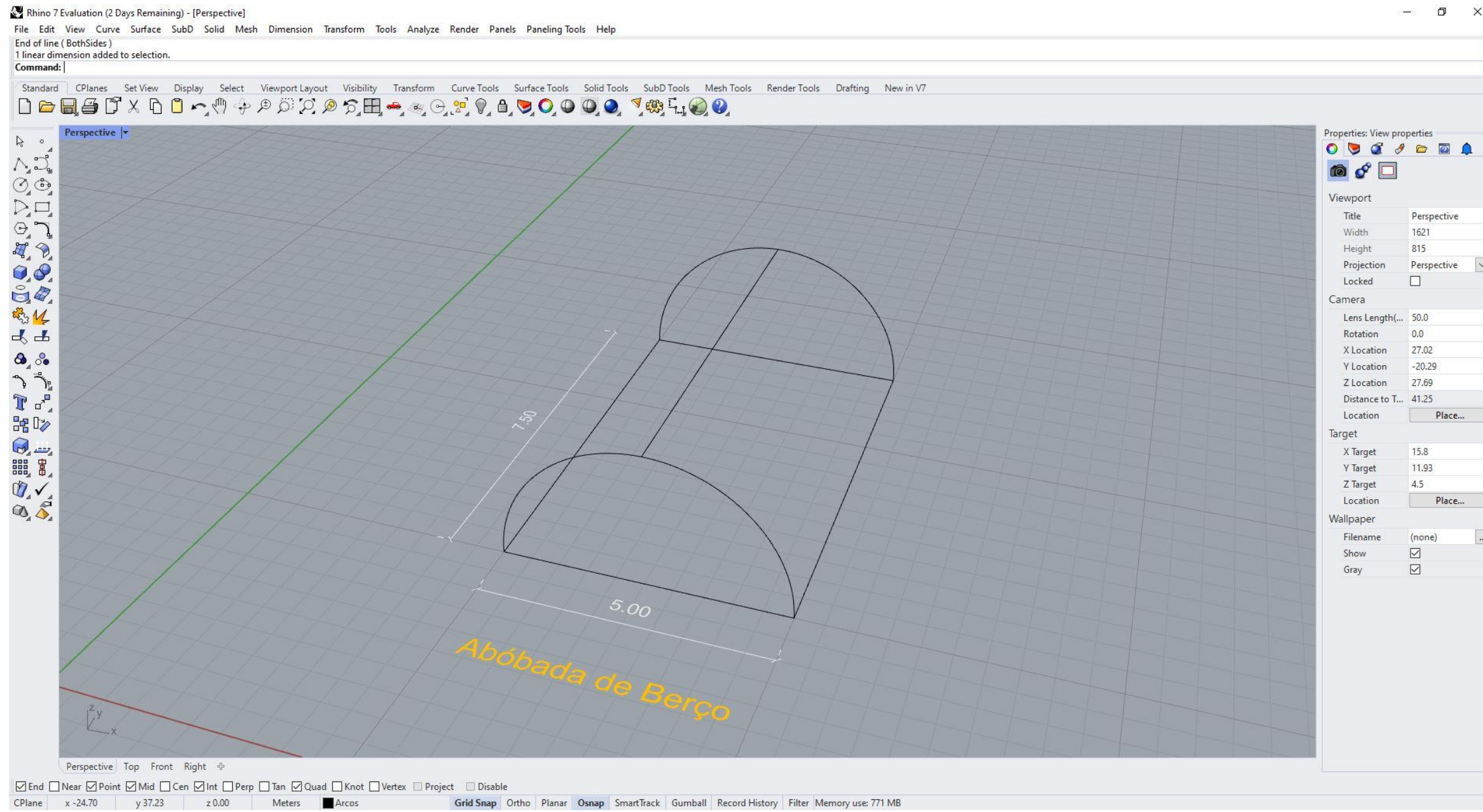

Exerc. 9.1 – Abóbada de Berço(Processo)

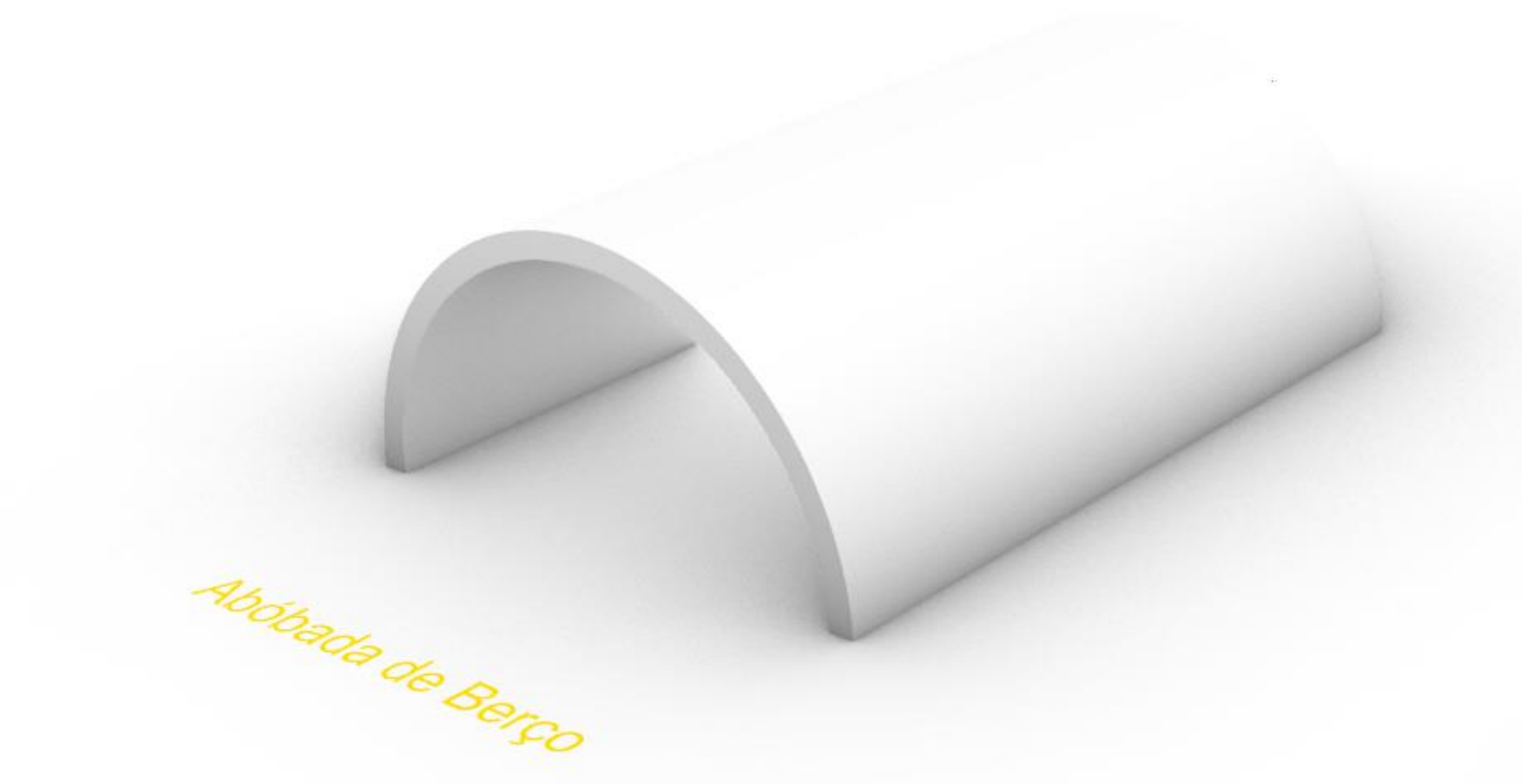

Exerc. 9.1 – Abóbada de Berço



Abóbada de Berço

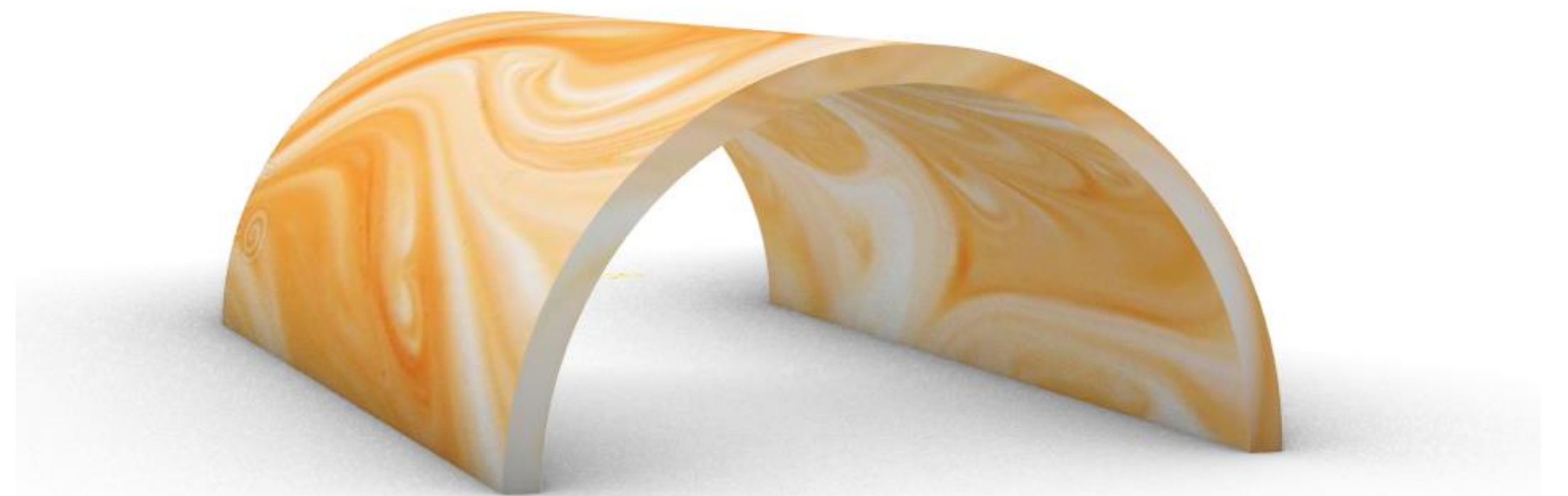

Exerc. 9.1 – Abóbada de Berço

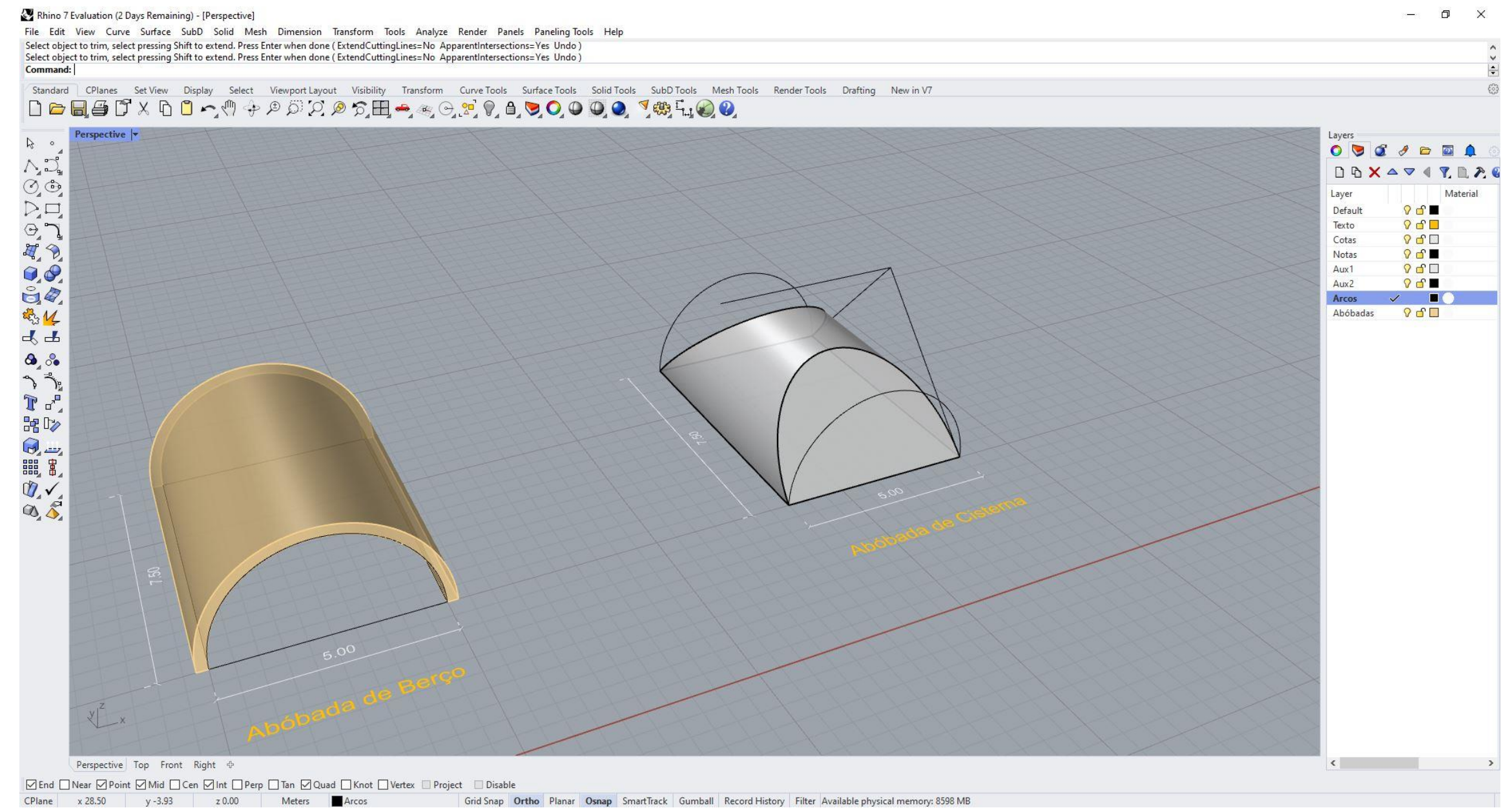
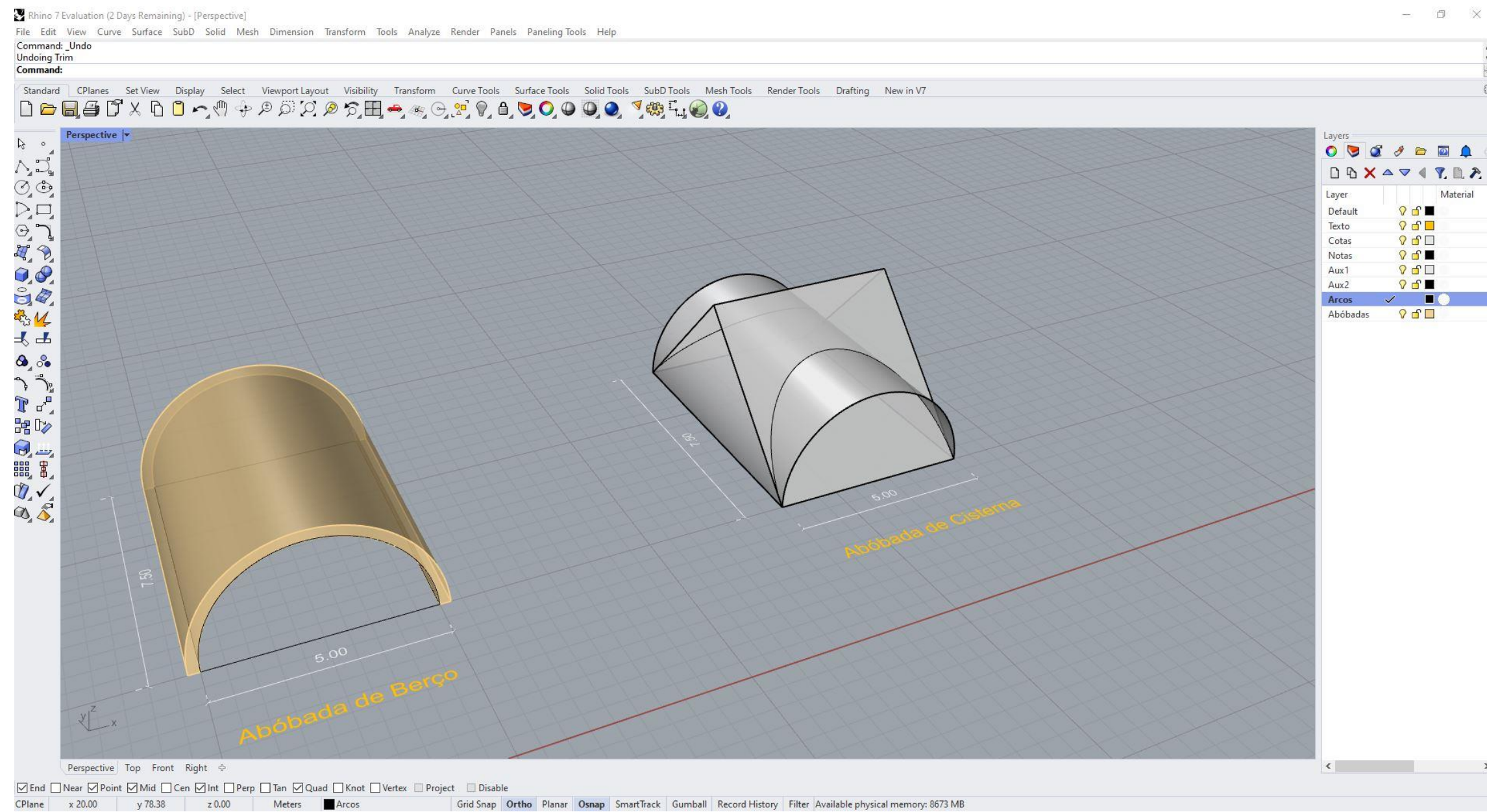

Exerc. 9.2 – Abóbada de Cisterna(Processo)

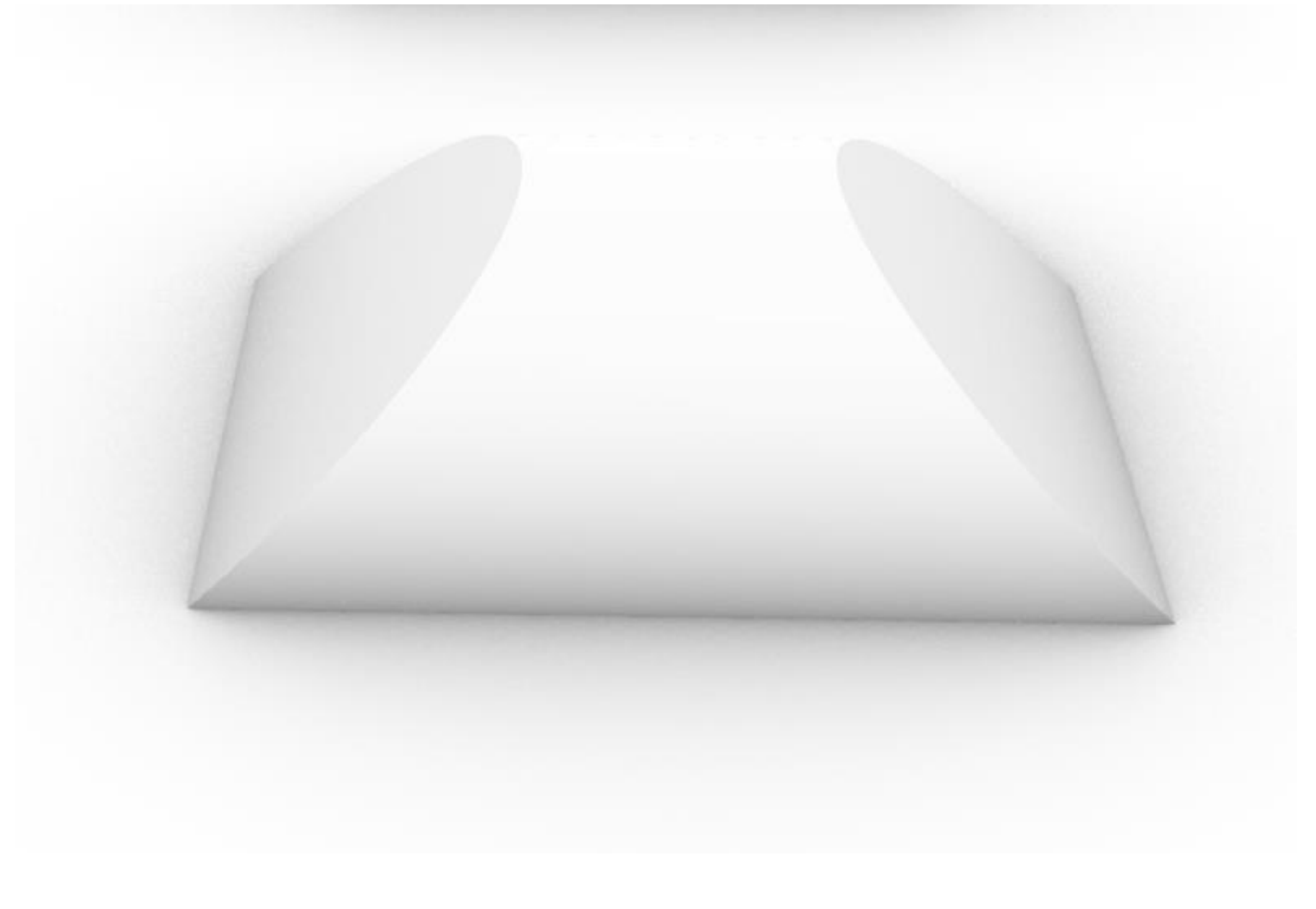

Exerc. 9.2 – Abóbada de Cisterna

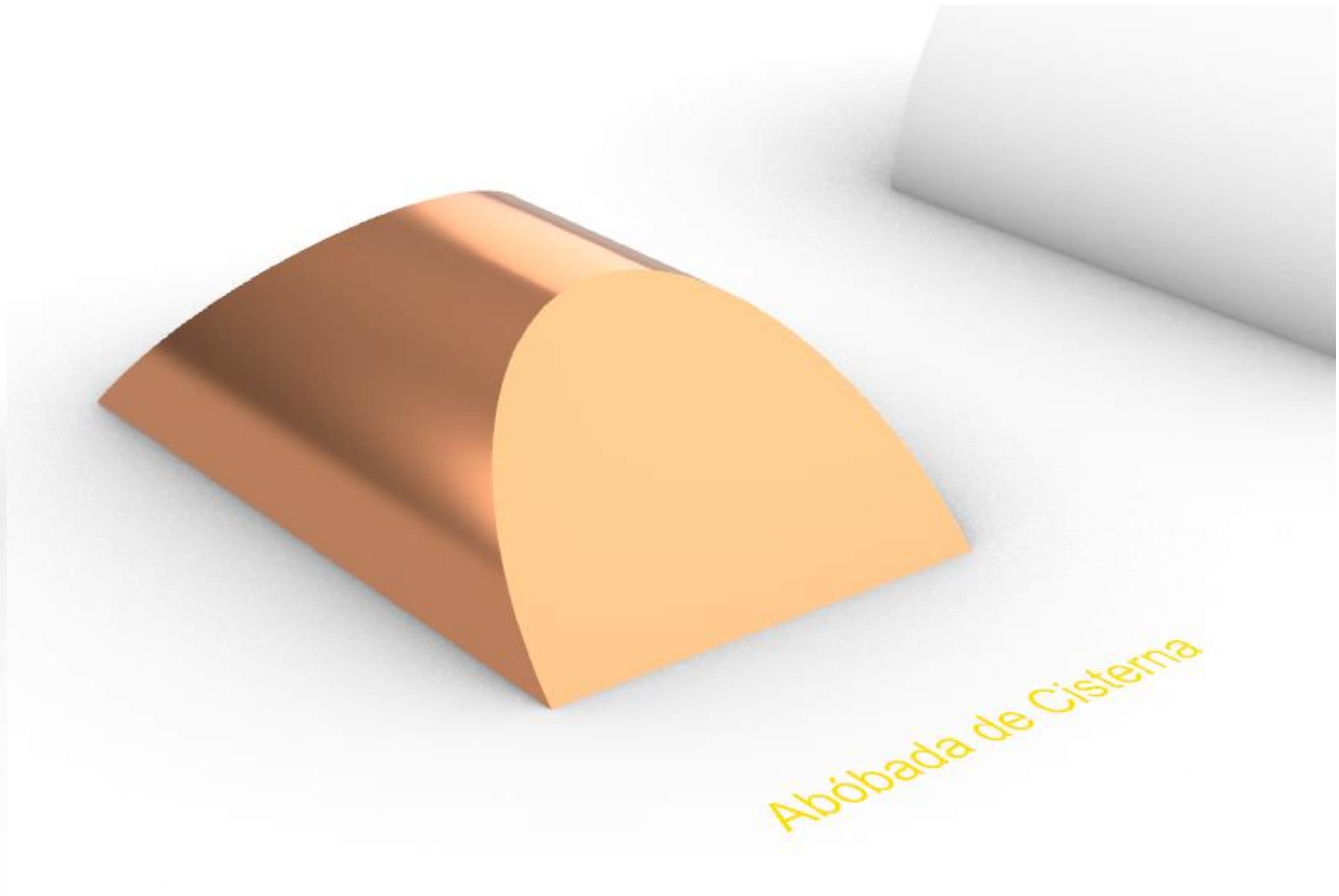
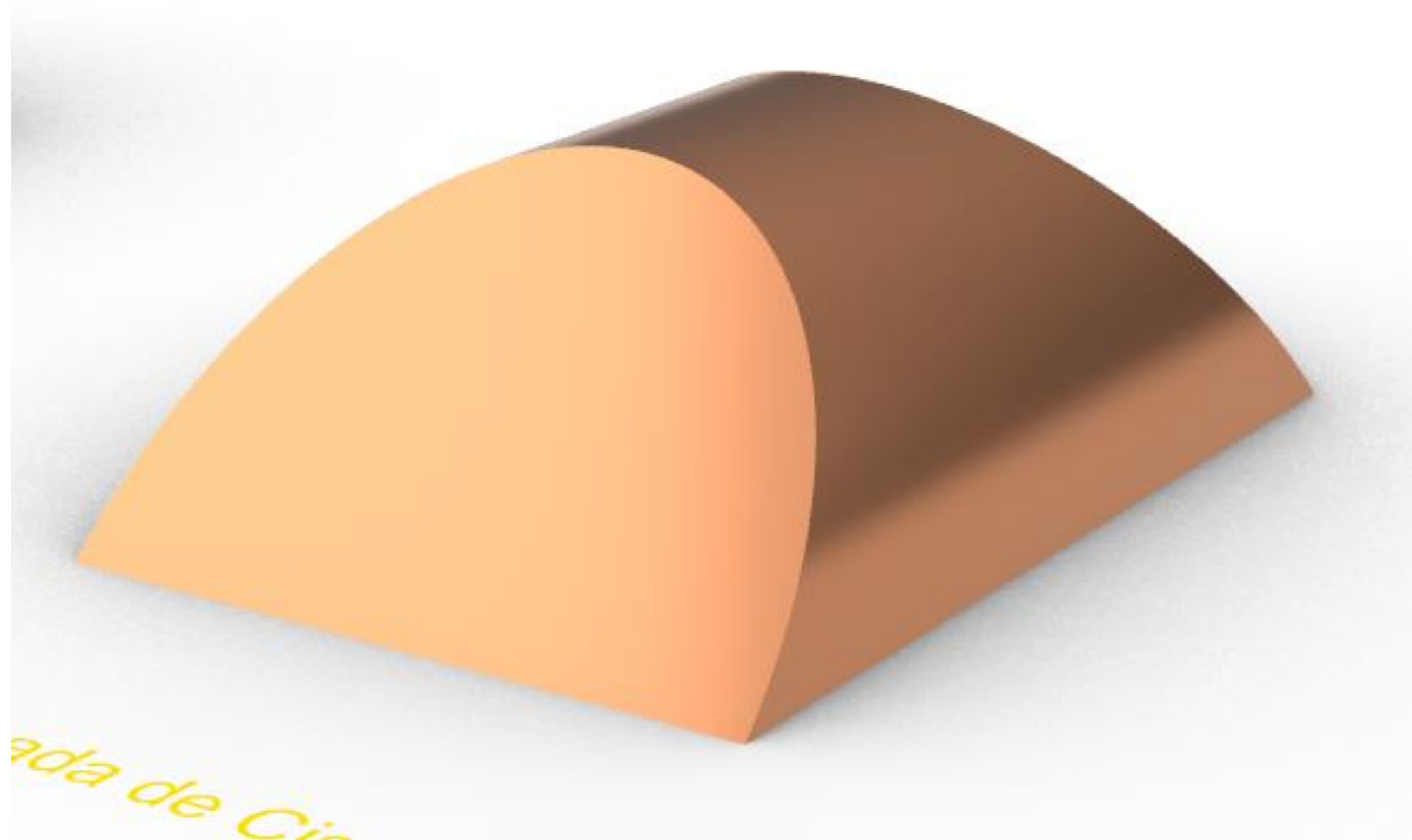

Exerc. 9.2 – Abóbada de Cisterna

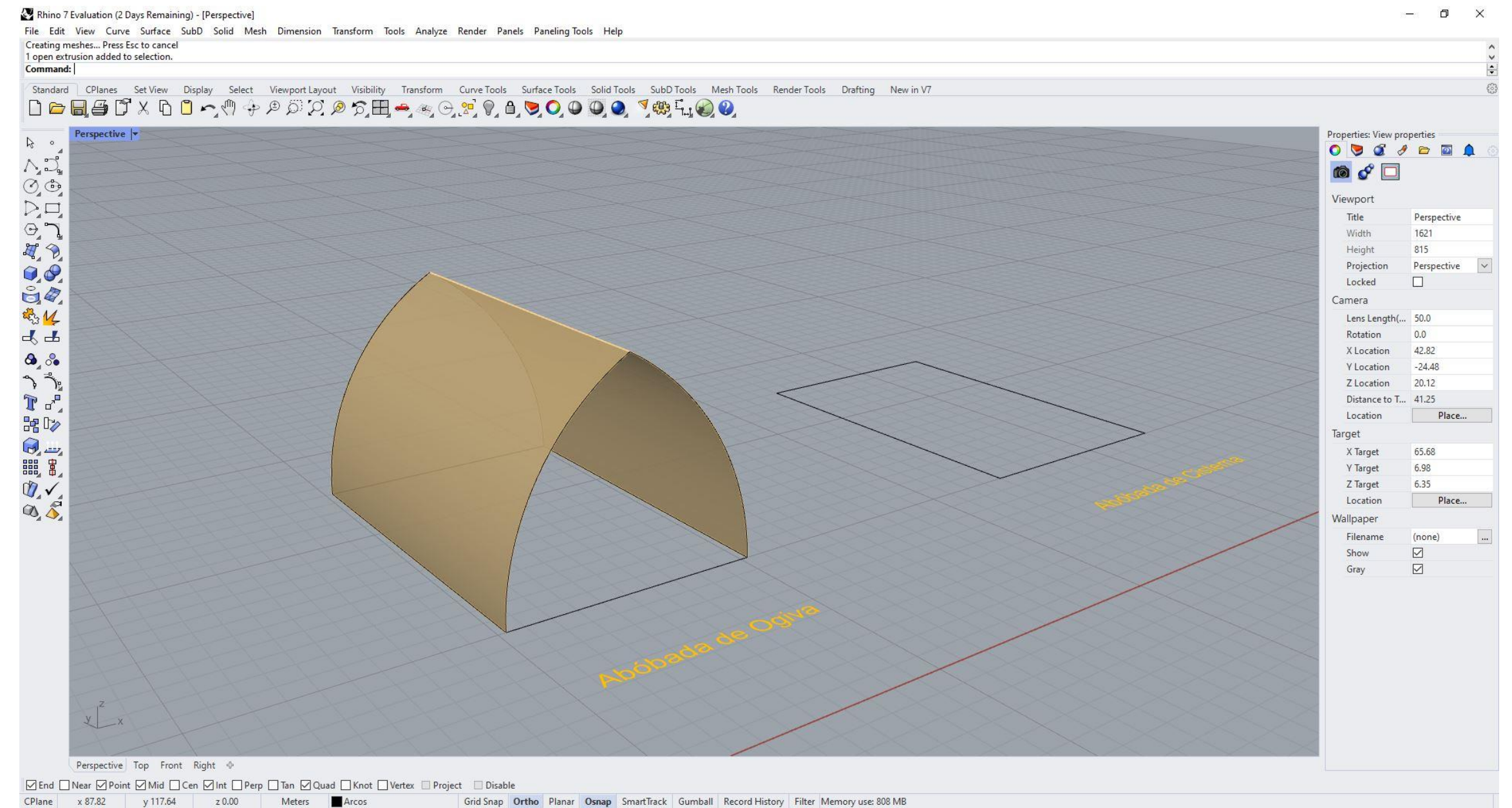
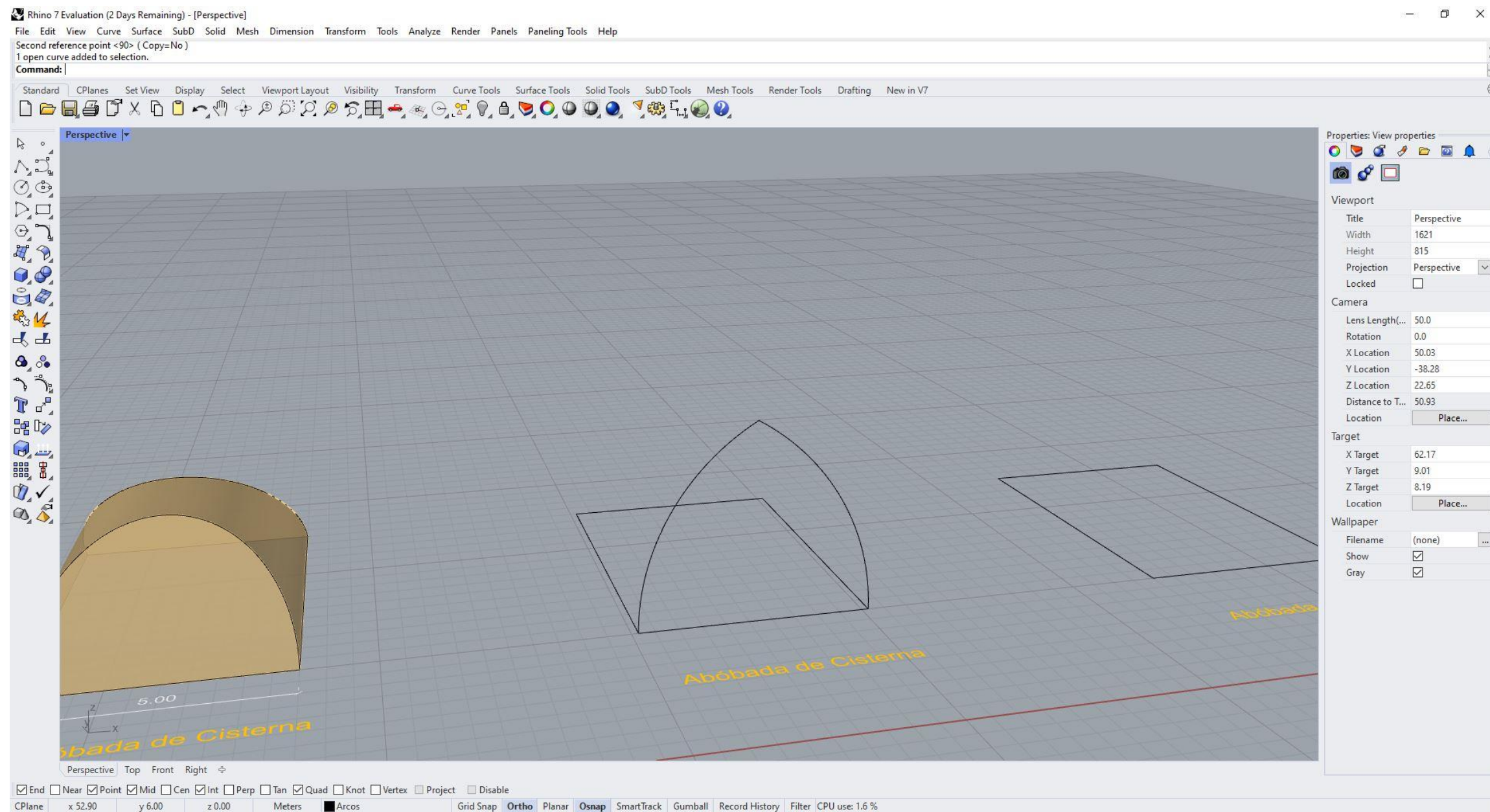

Exerc. 9.3 – Abóbada de Ogiva(Processo)

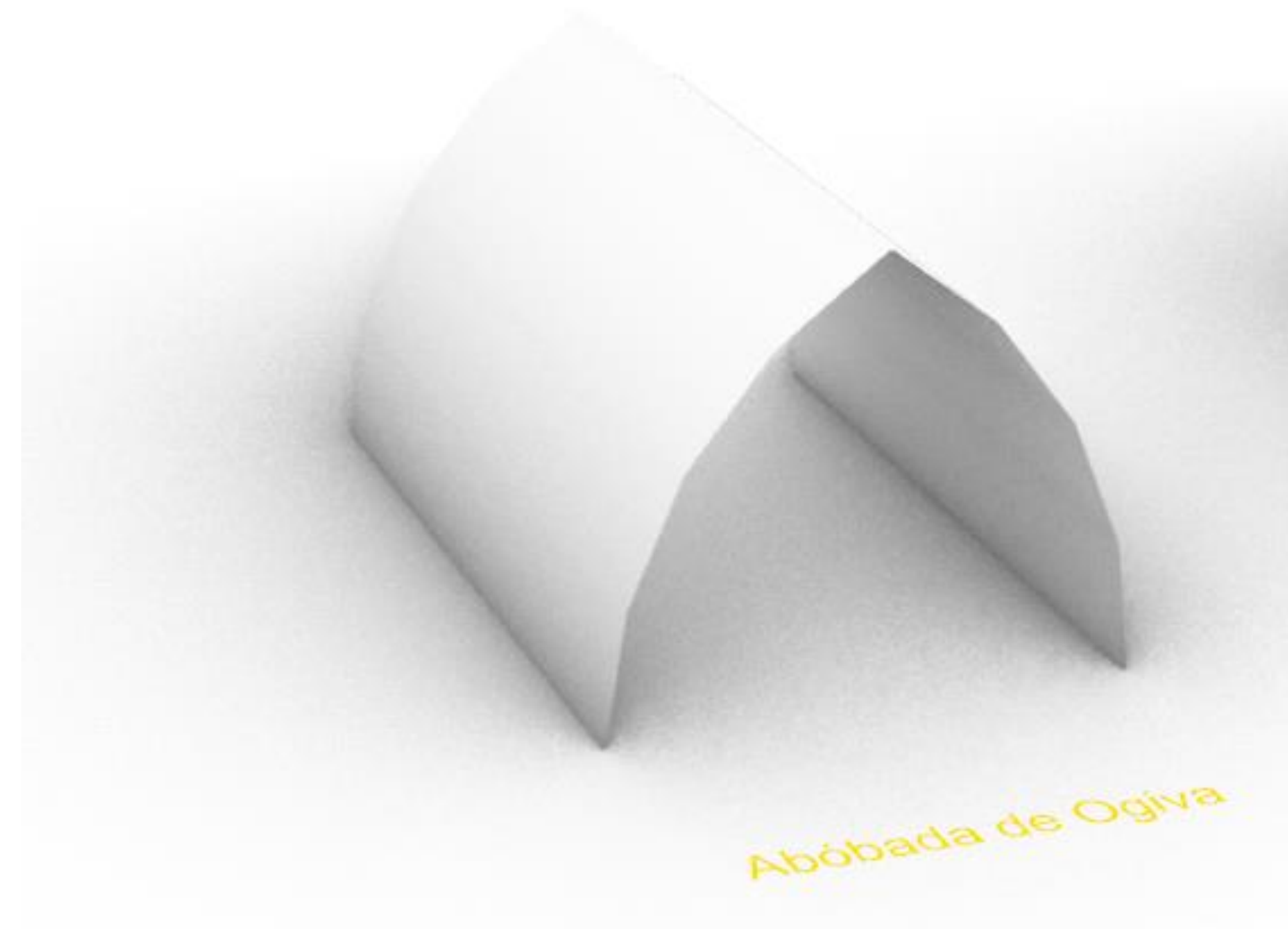
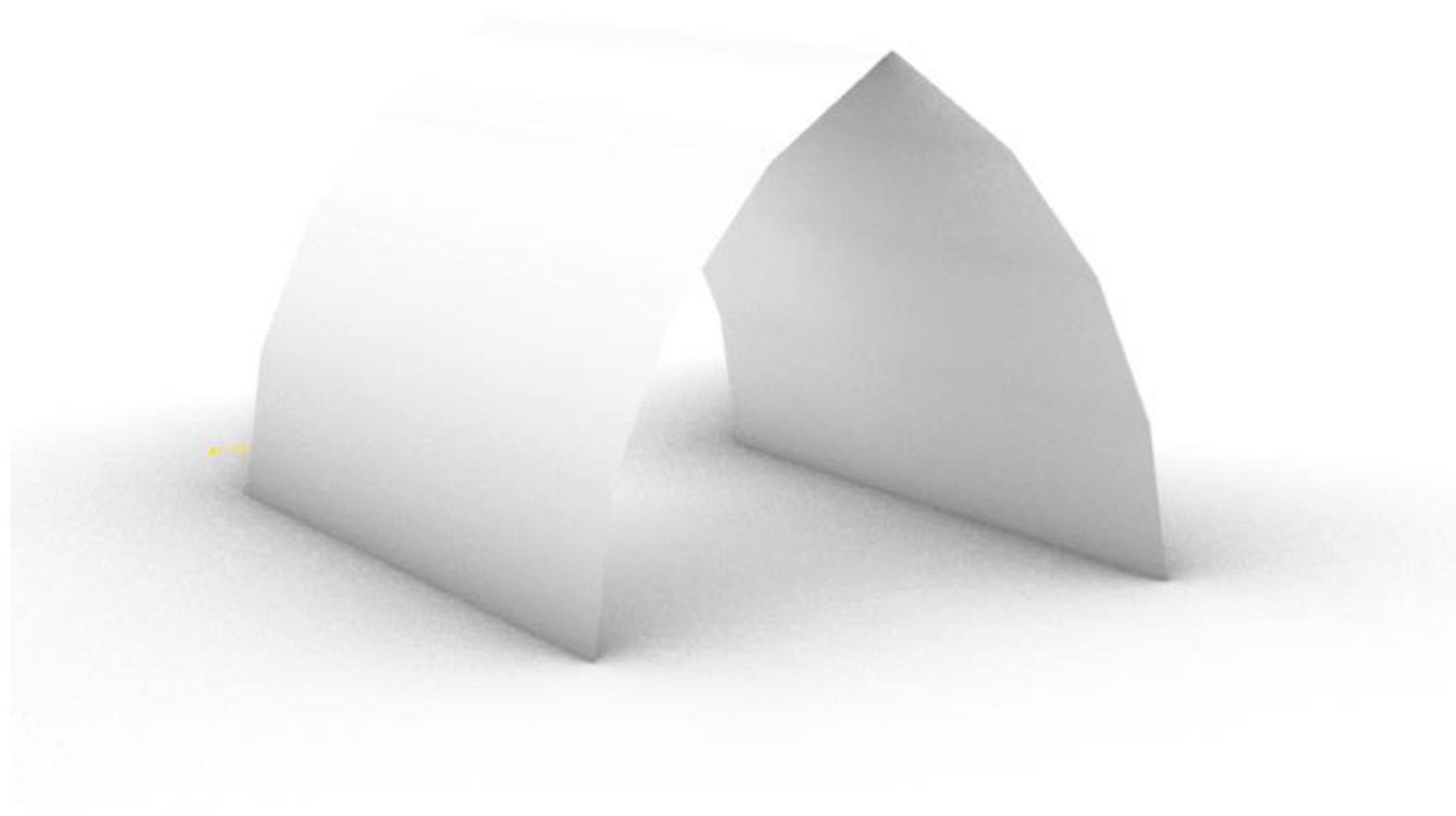

Exerc. 9.3 – Abóbada de Ogiva

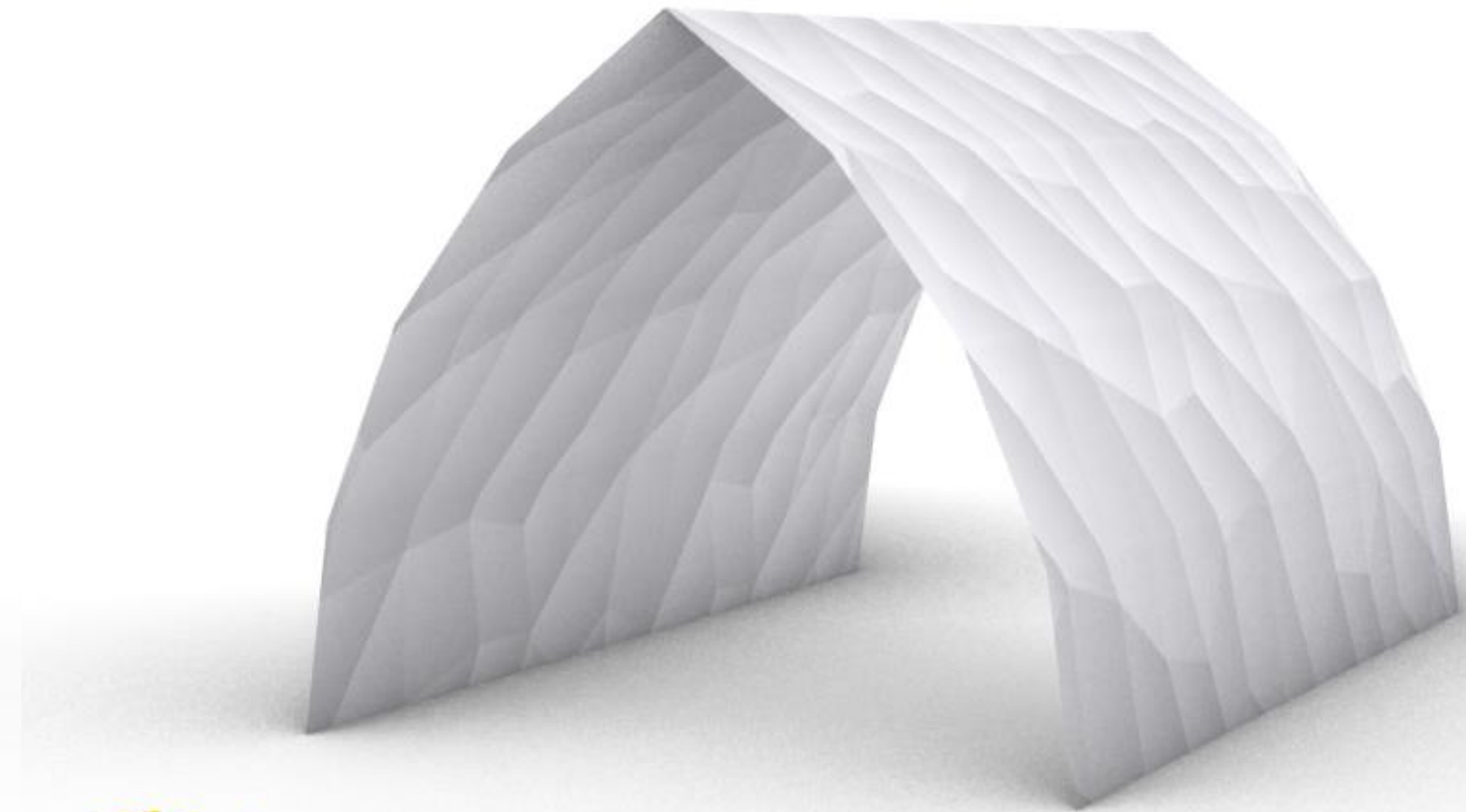
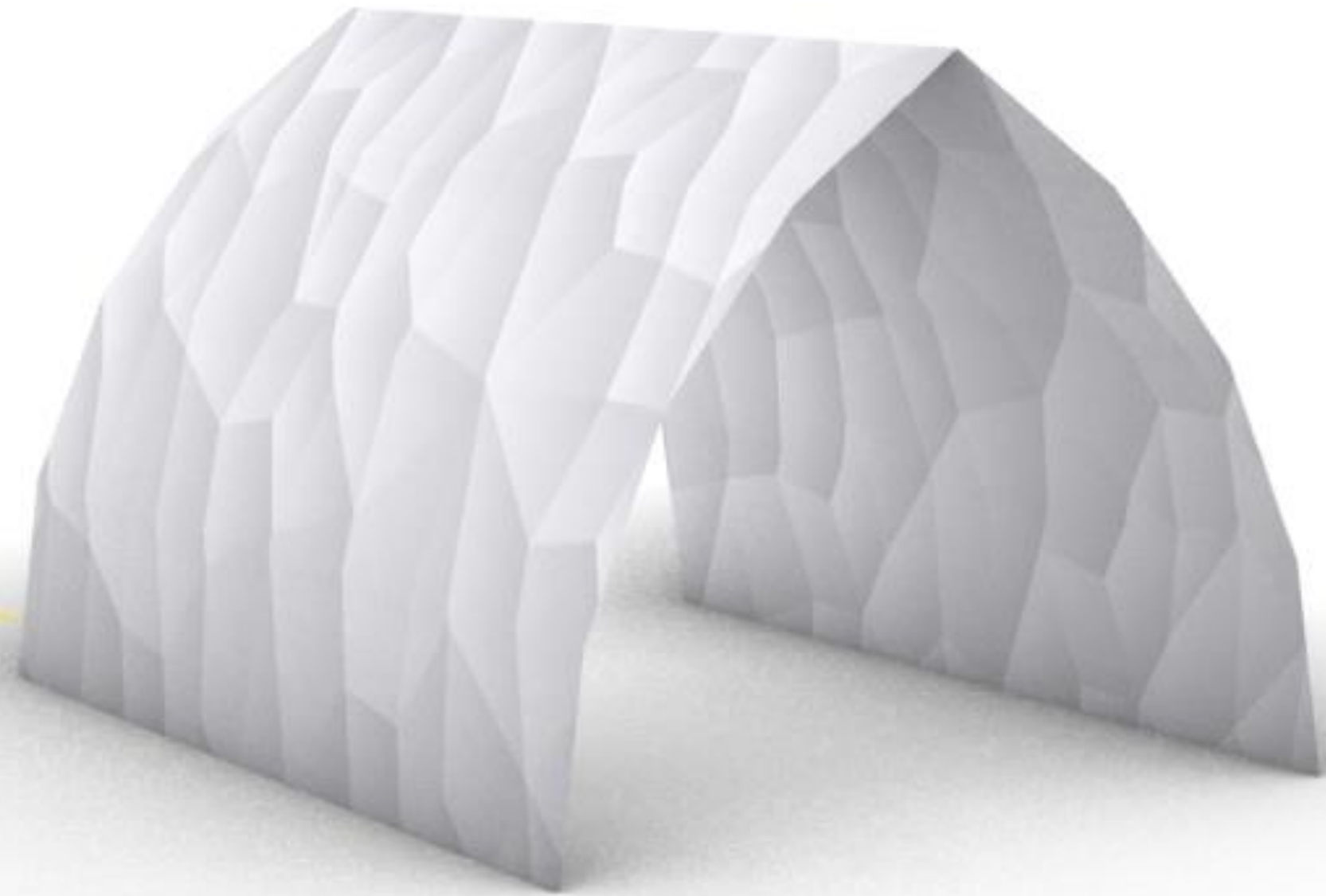

Abóbada de Ogiva

Exerc. 9.3 – Abóbada de Ogiva

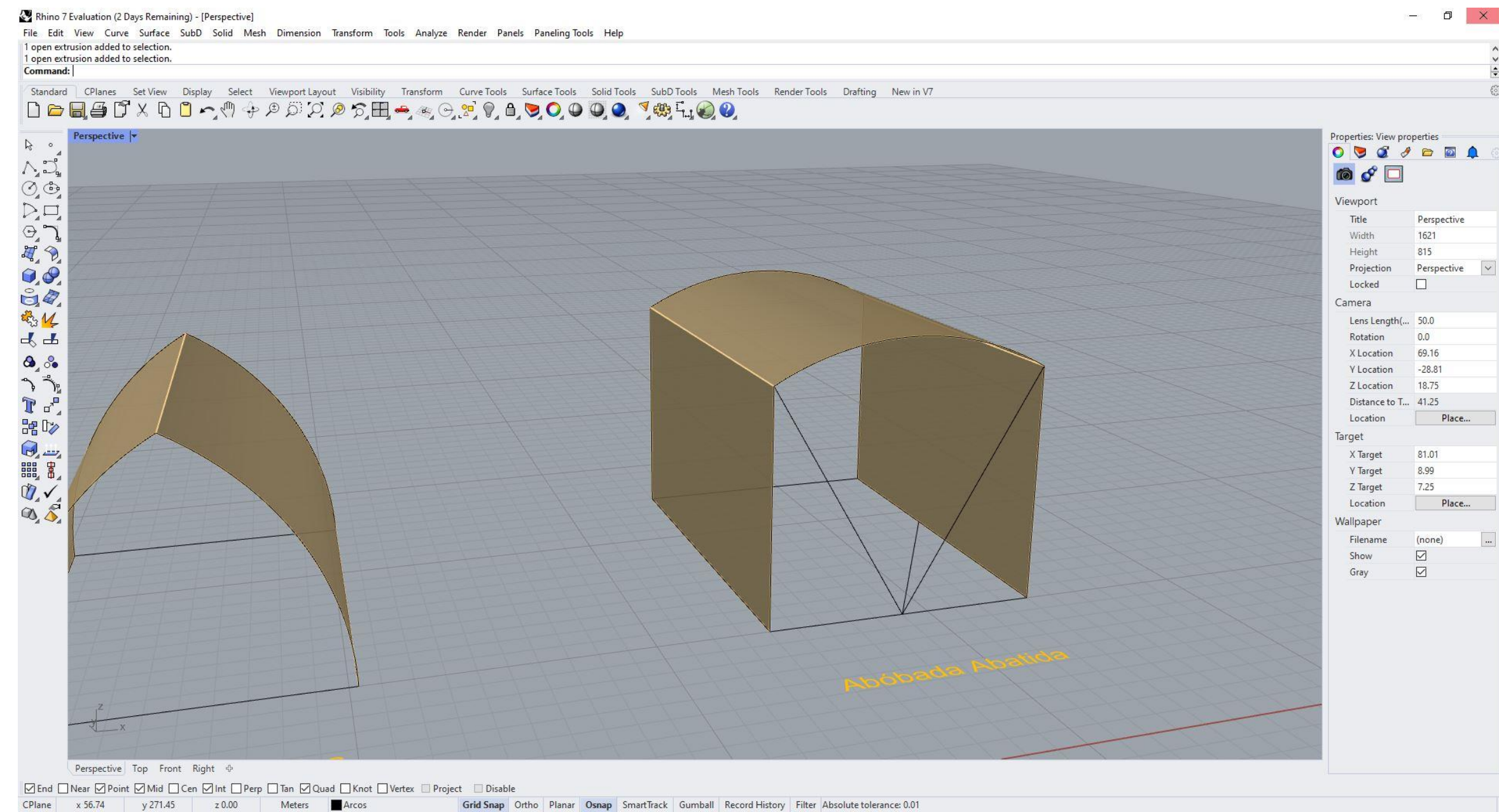
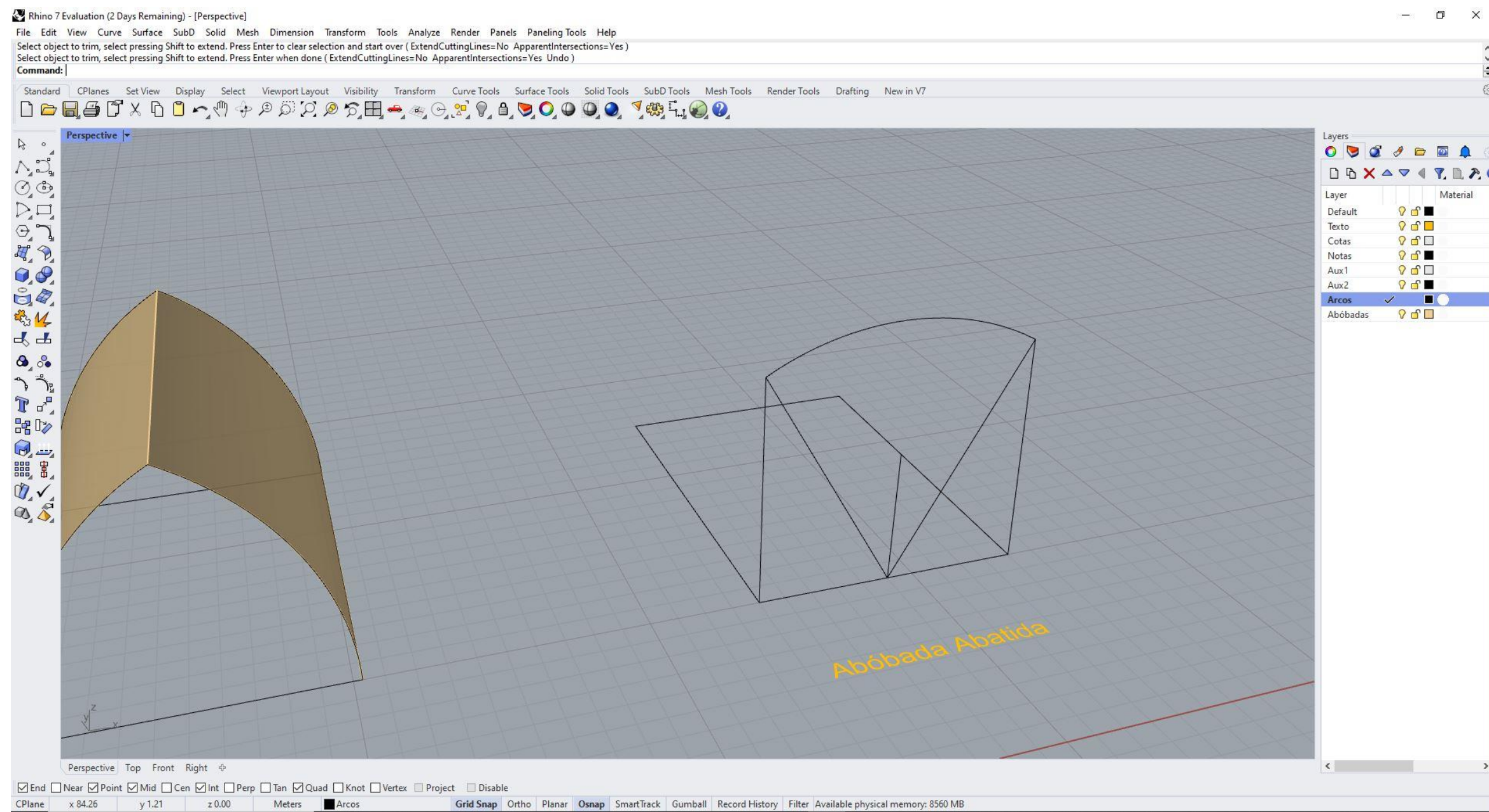

Exerc. 9.4 – Abóbada Abatida (Processo)

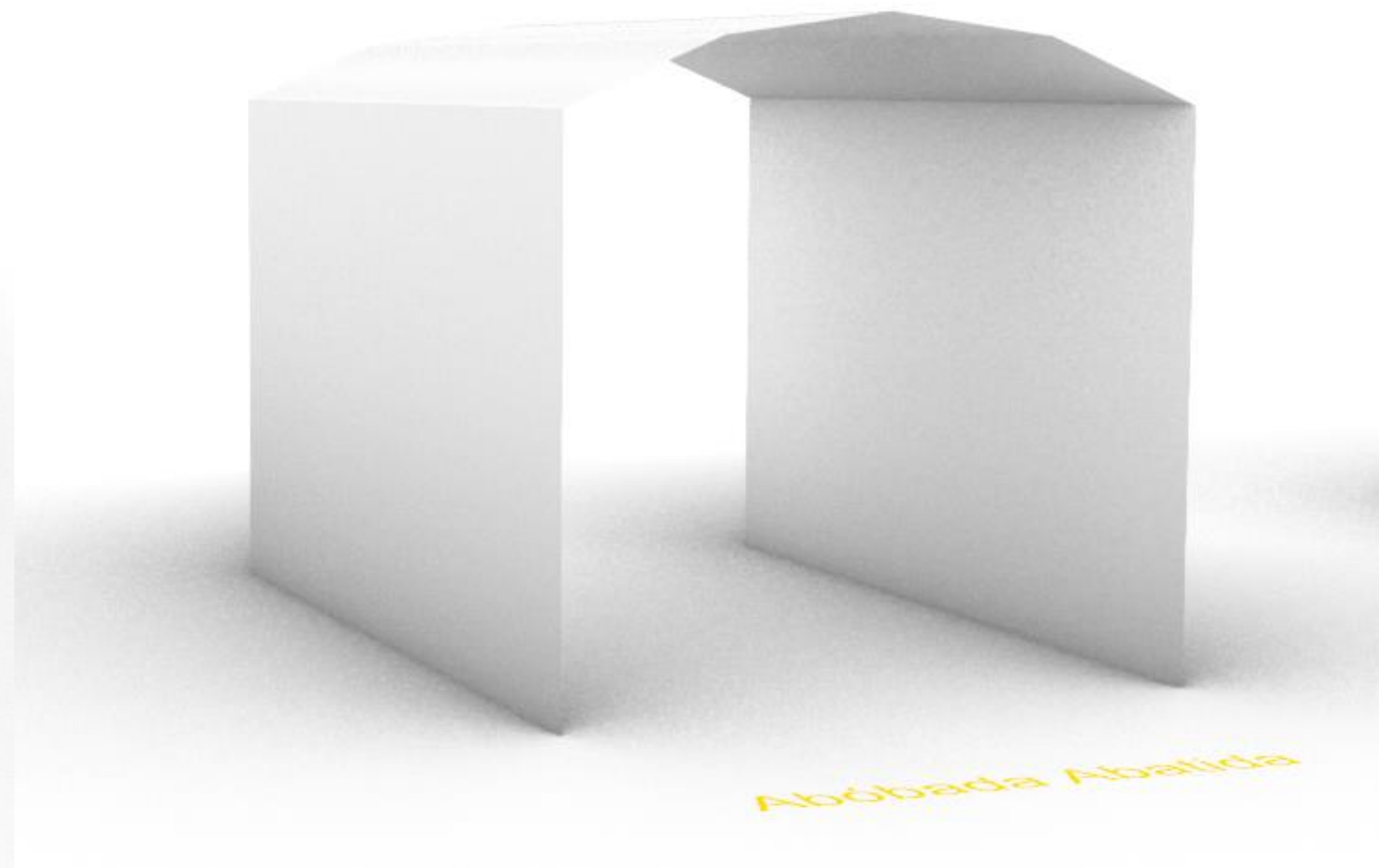
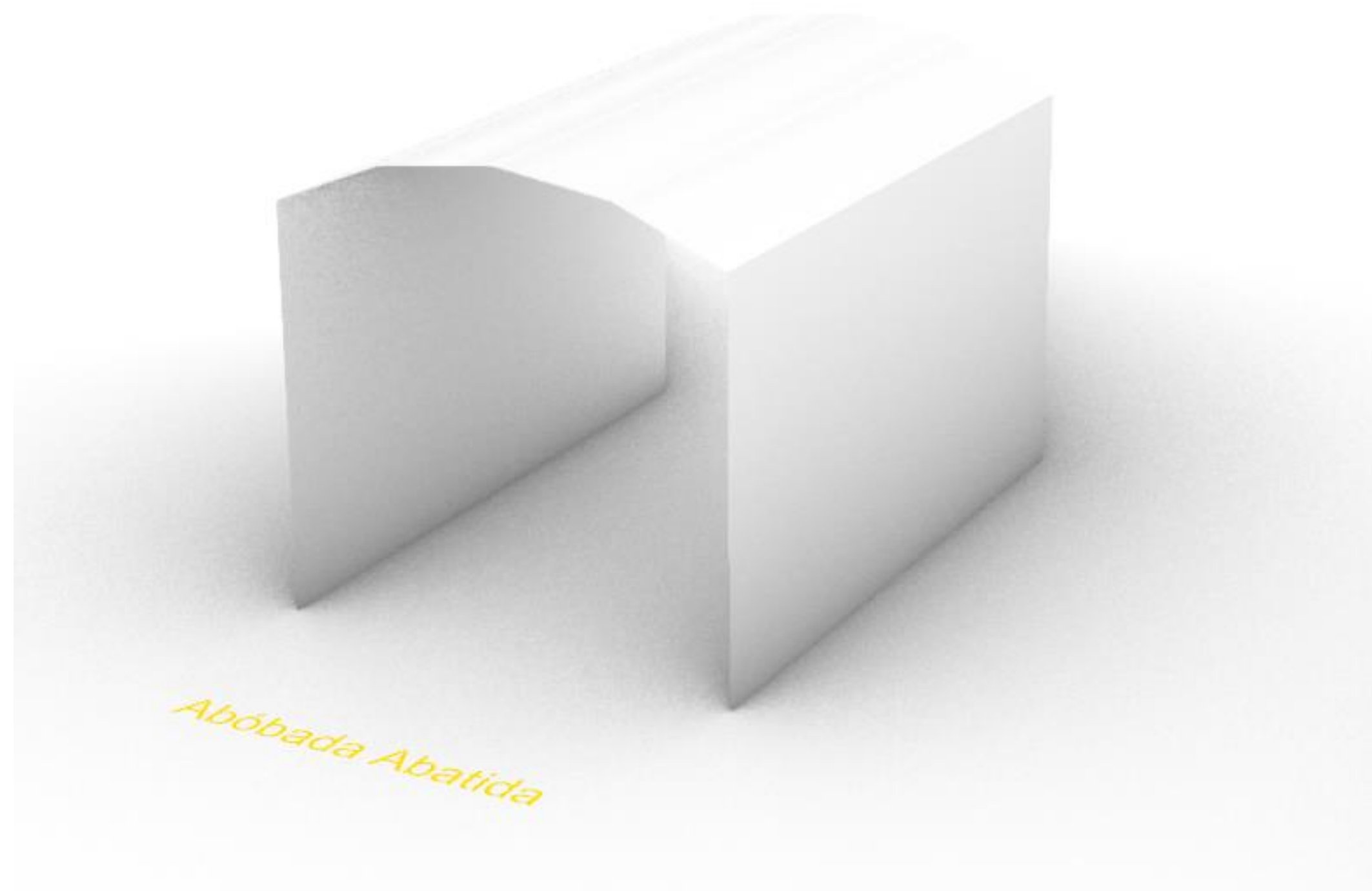

Exerc. 9.4 – Abóbada Abatida

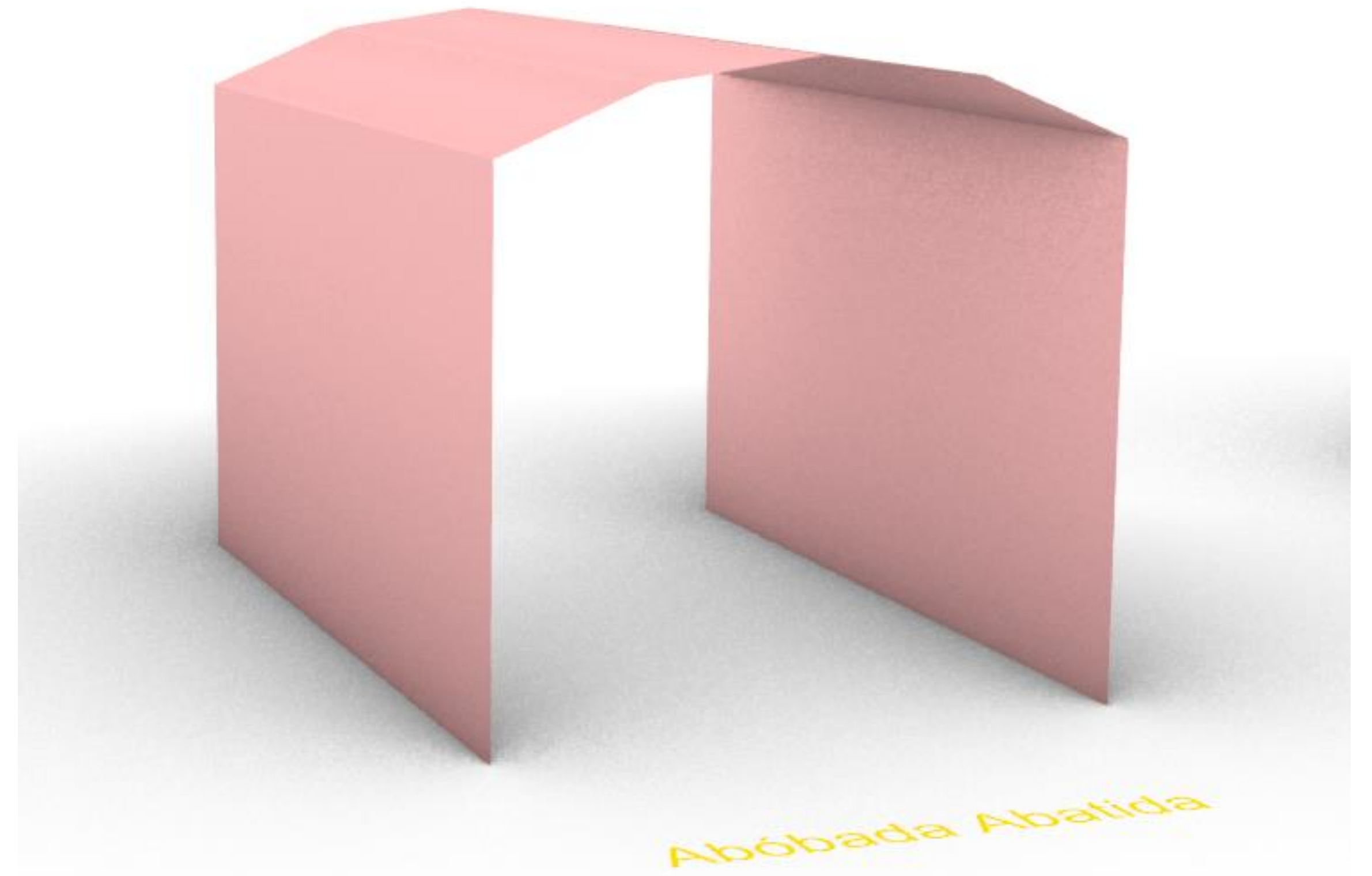
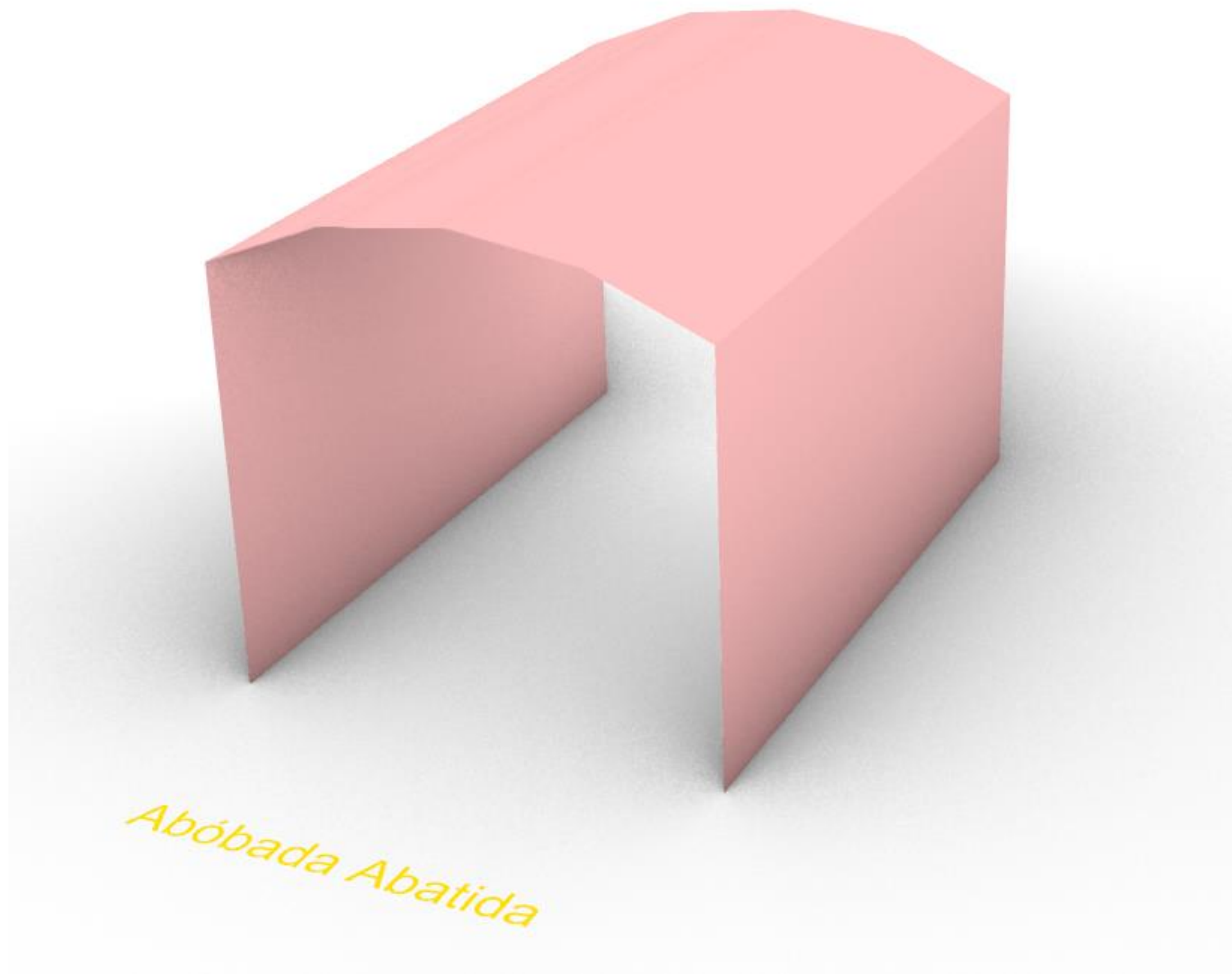

Exerc. 9.4 – Abóbada Abatida

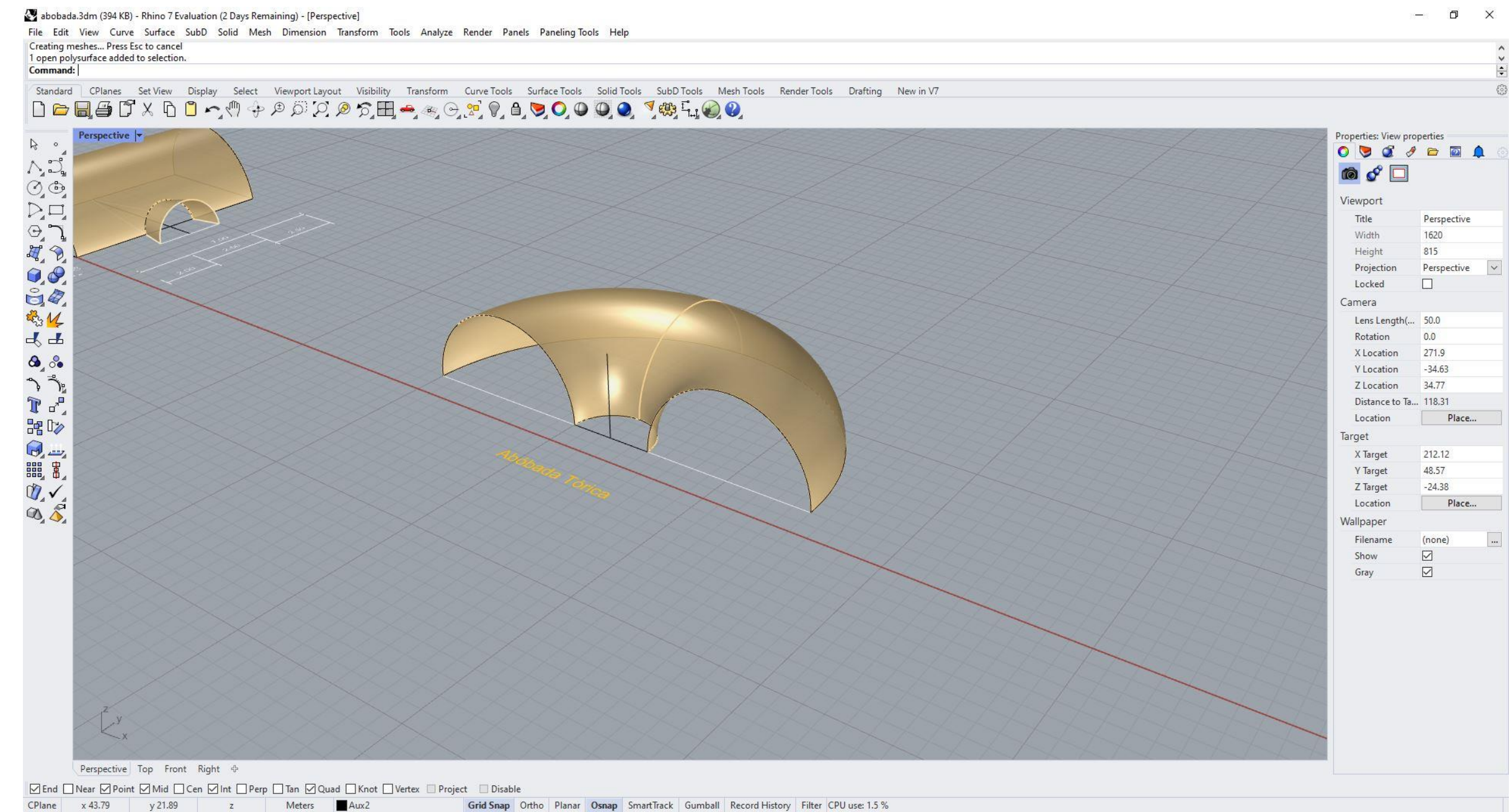
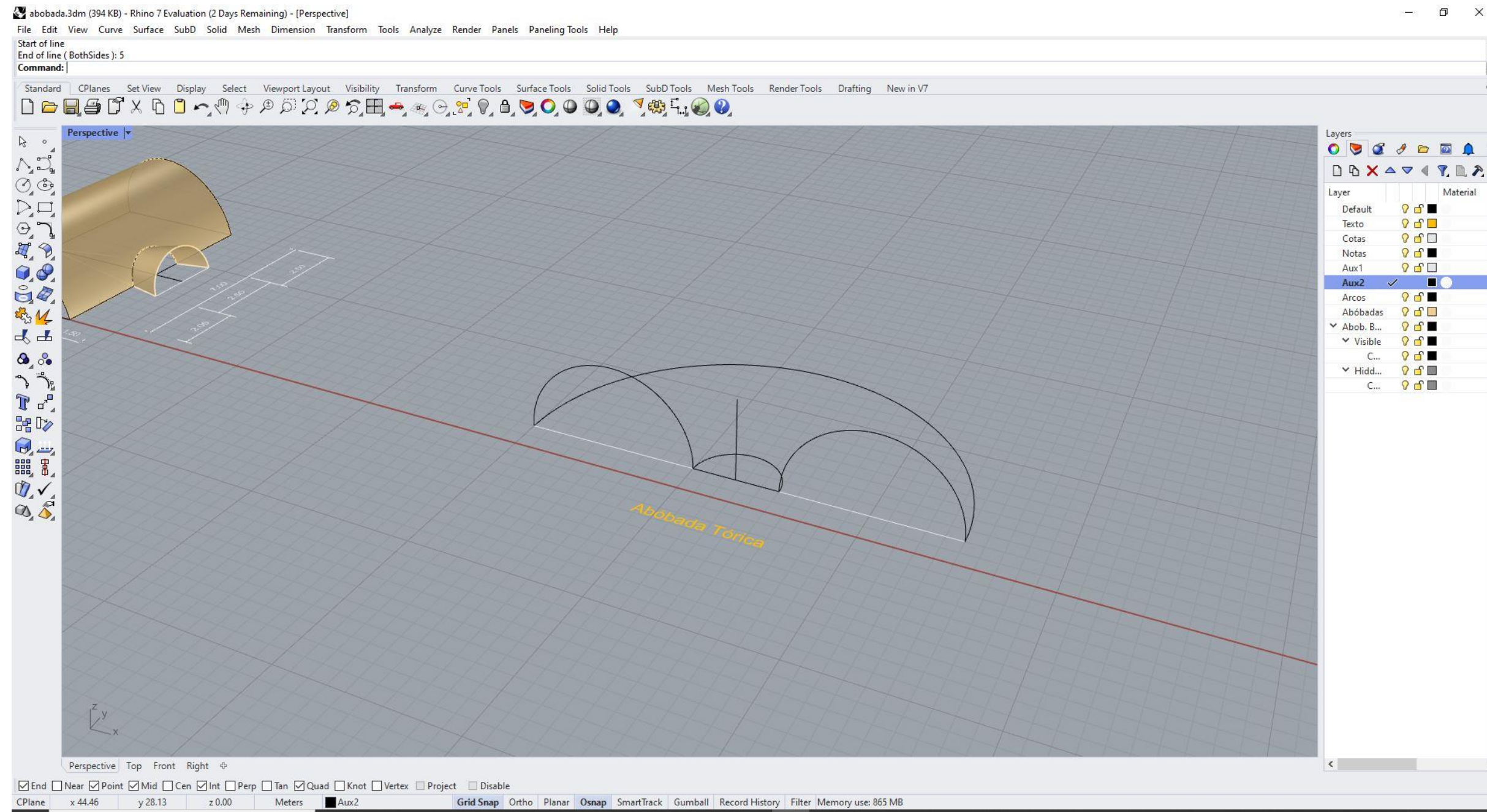

Exerc. 9.5 – Abóbada Tórica (Processo)

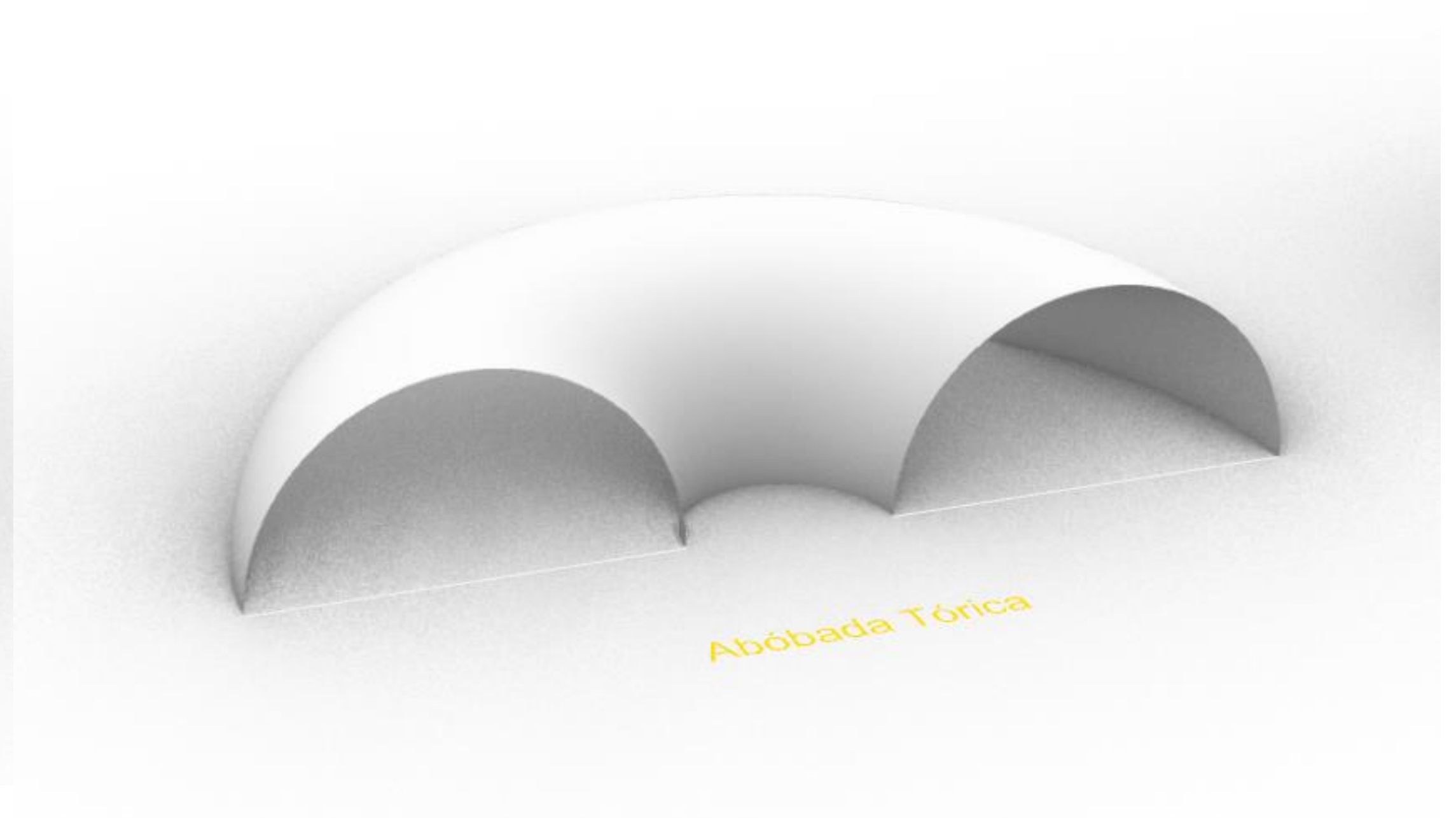
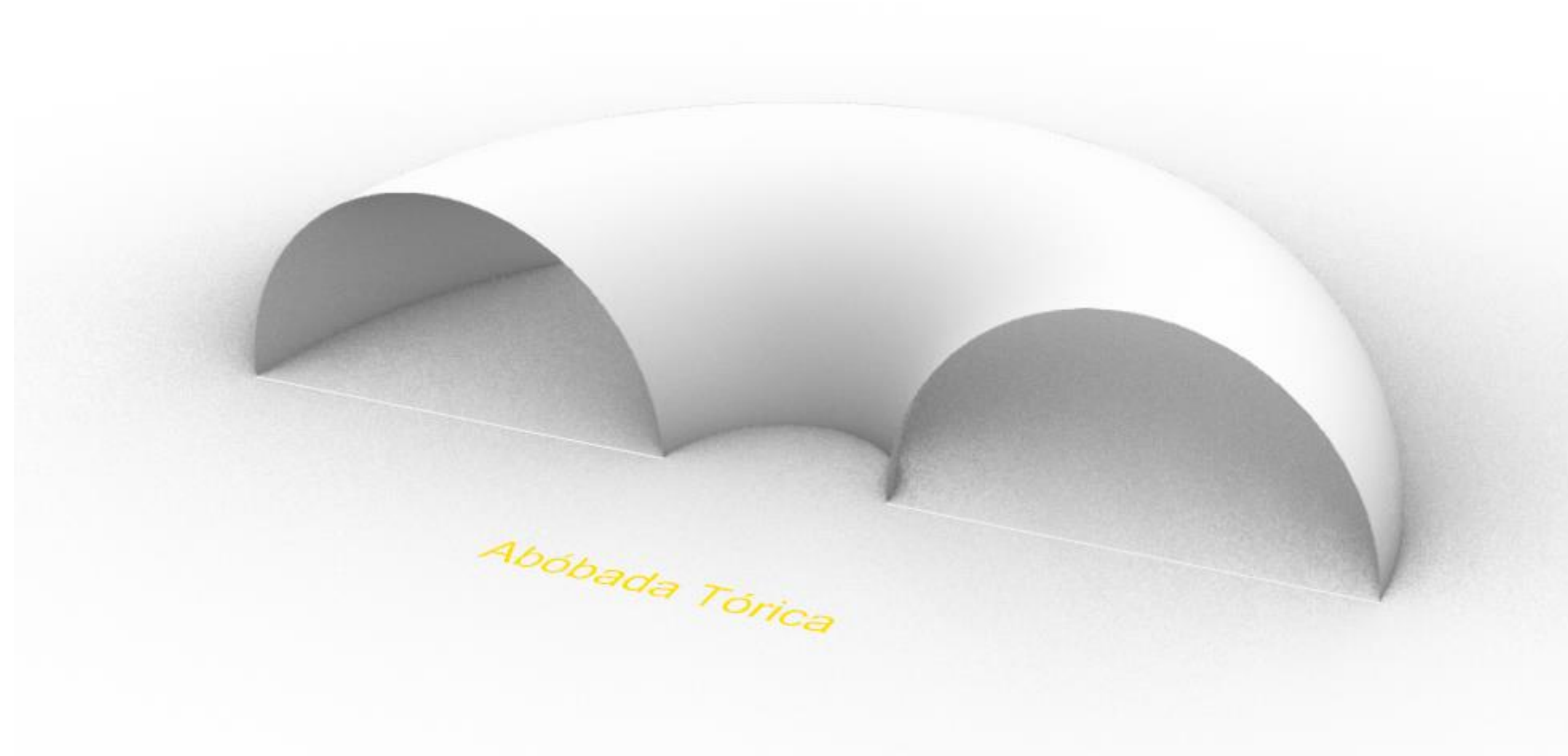

Exerc. 9.5 – Abóbada Tórica

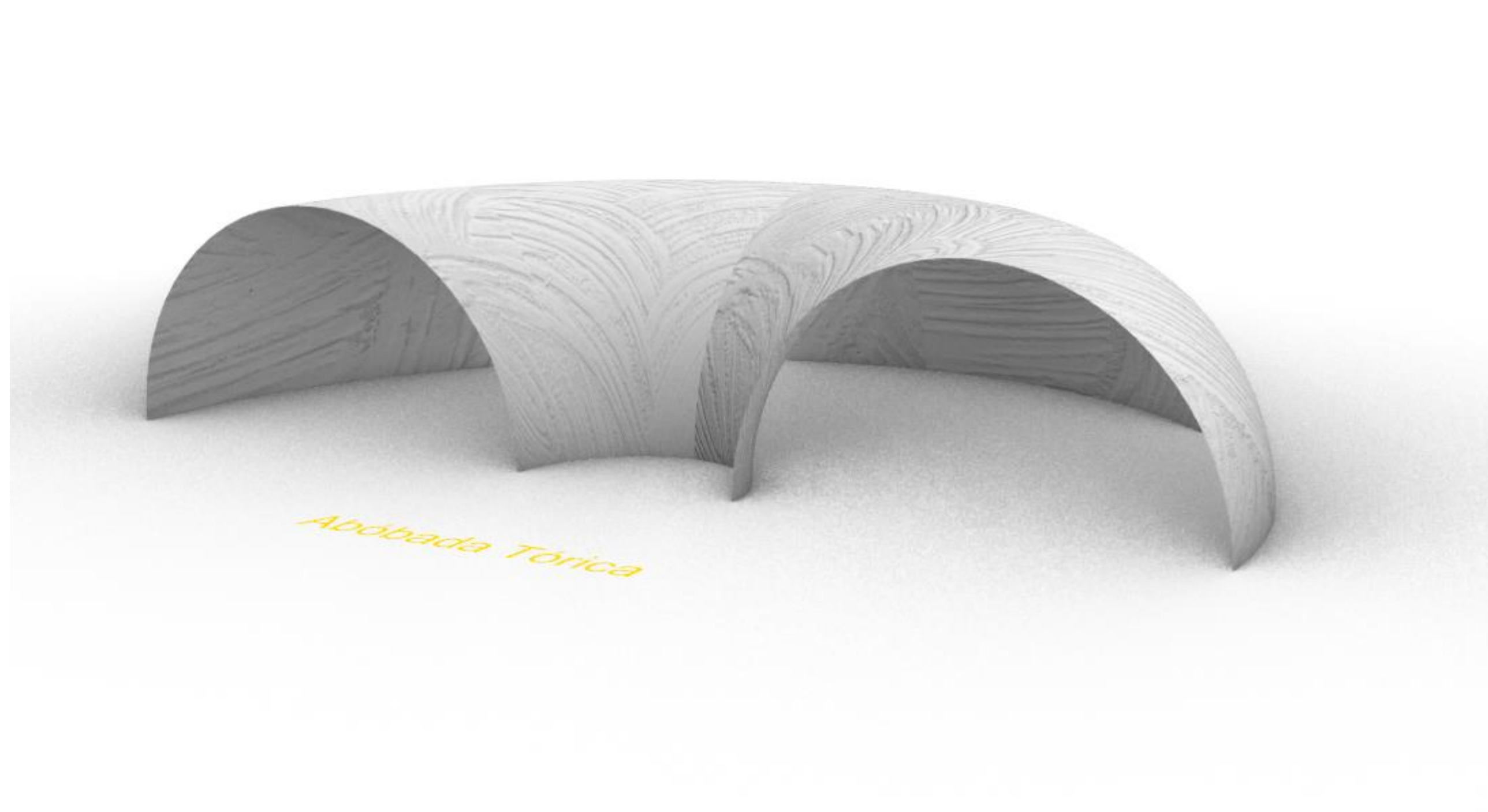

Exerc. 9.5 – Abóbada Tórica

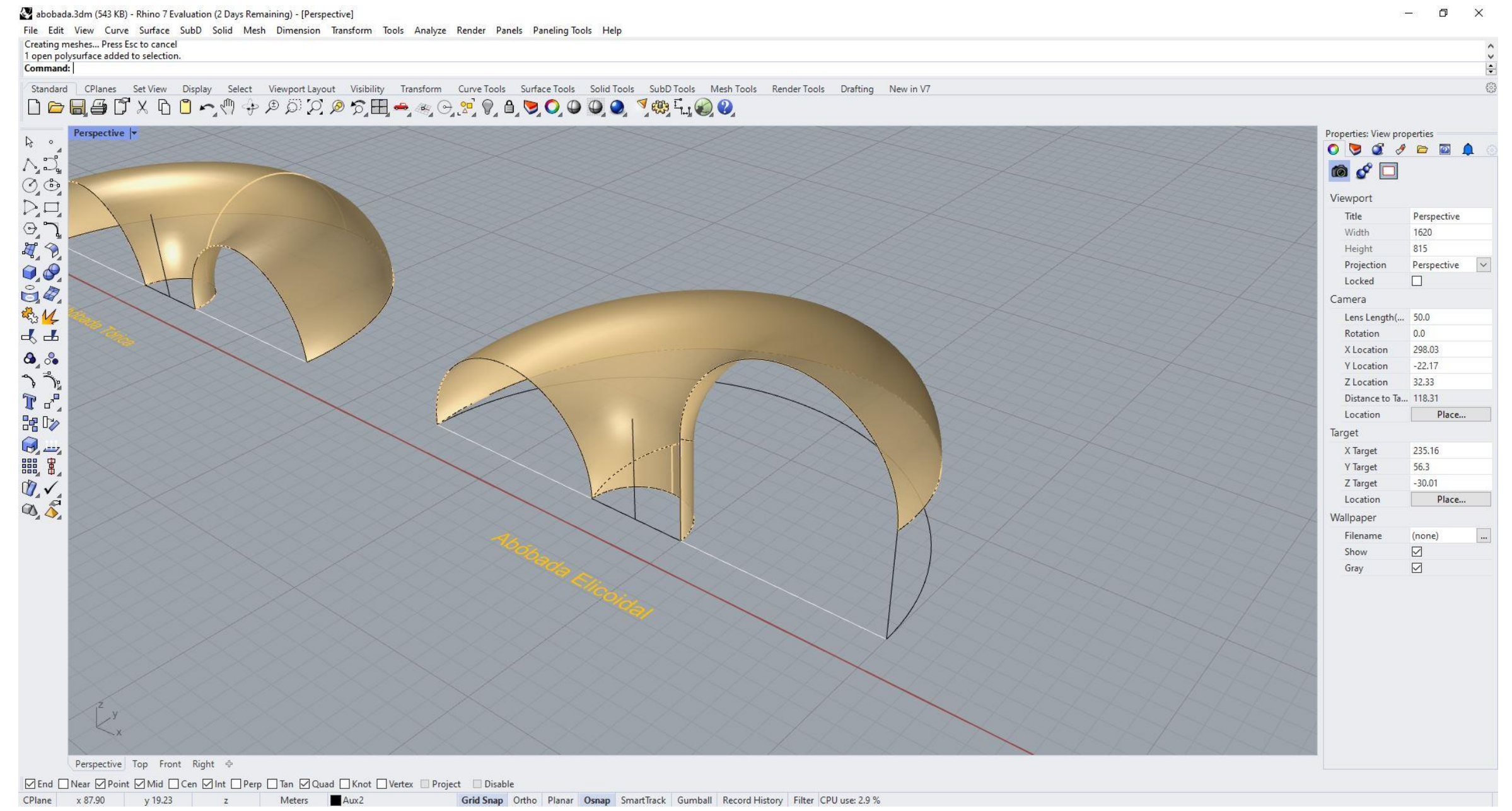
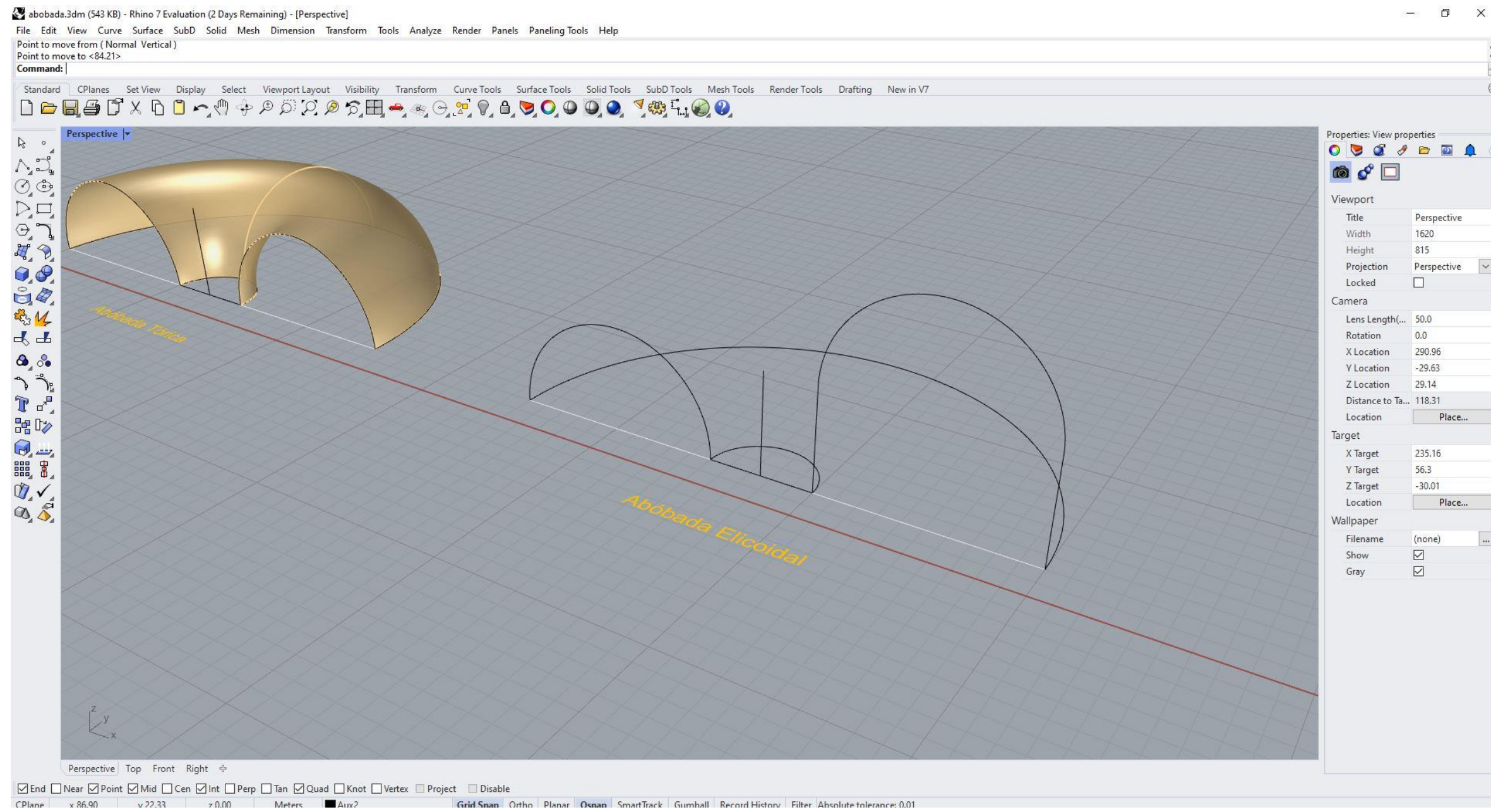

Exerc. 9.6 – Abóbada Helicoidal(Processo)

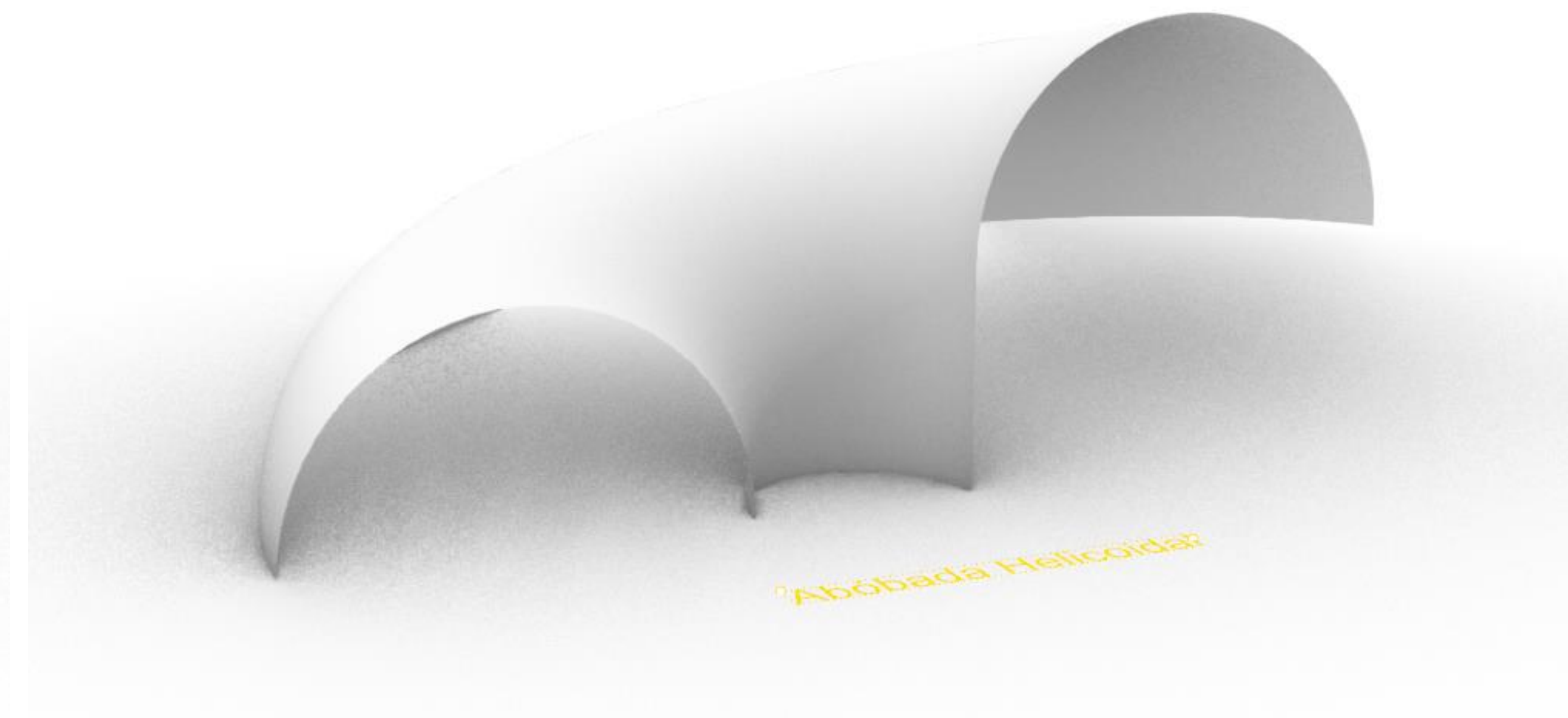
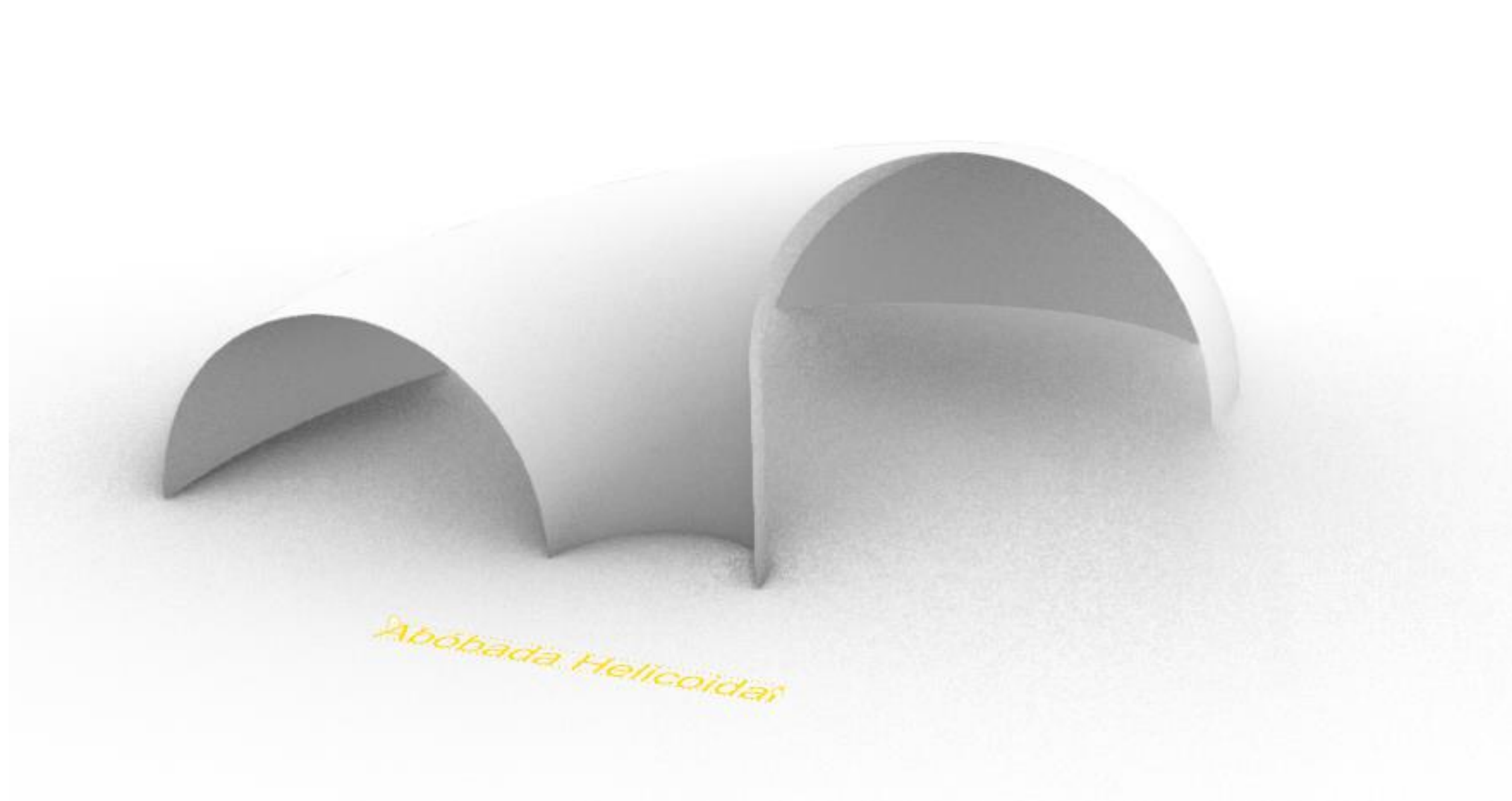

Exerc. 9.6 – Abóbada Helicoidal

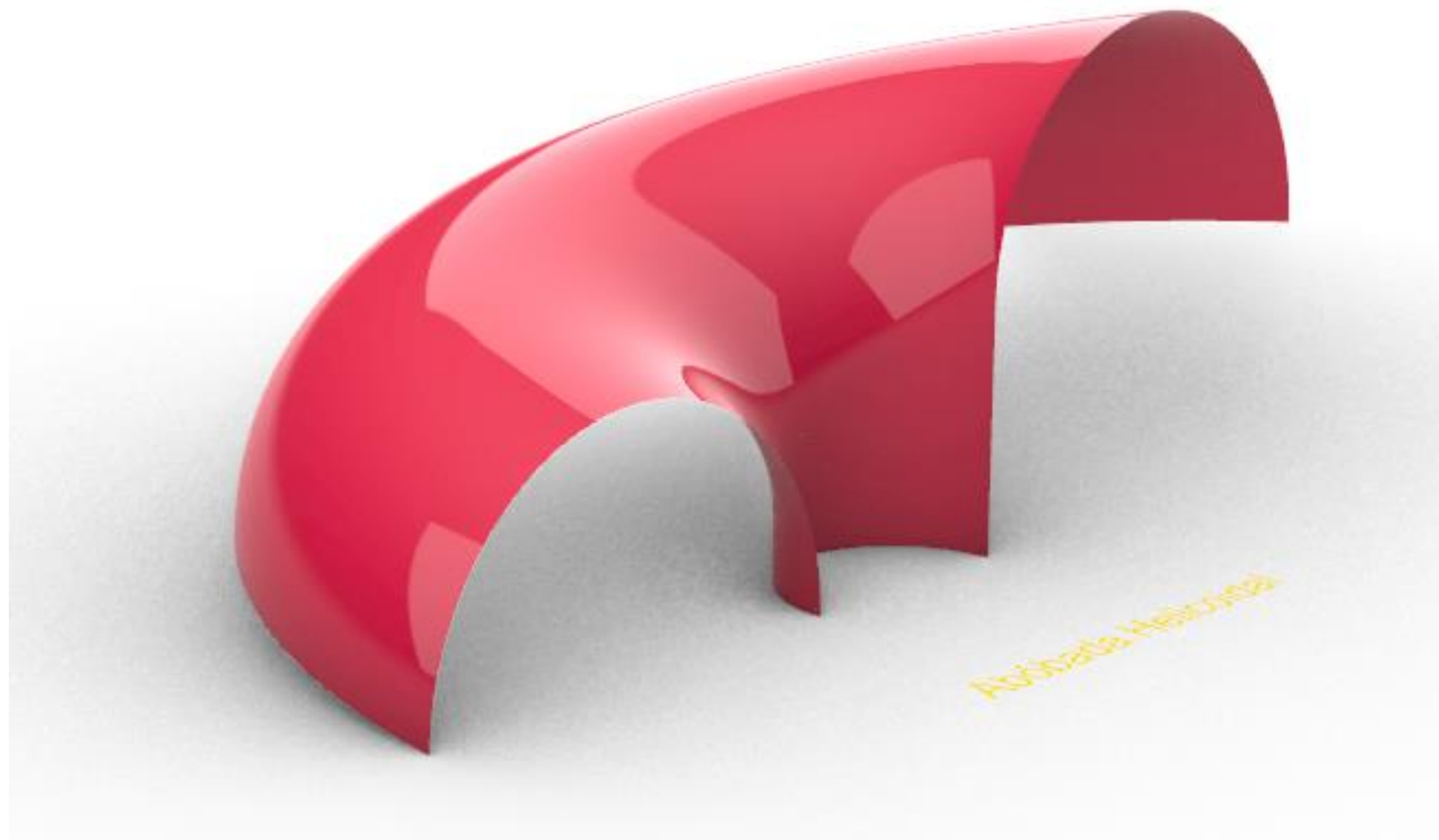

Exerc. 9.6 – Abóbada Helicoidal

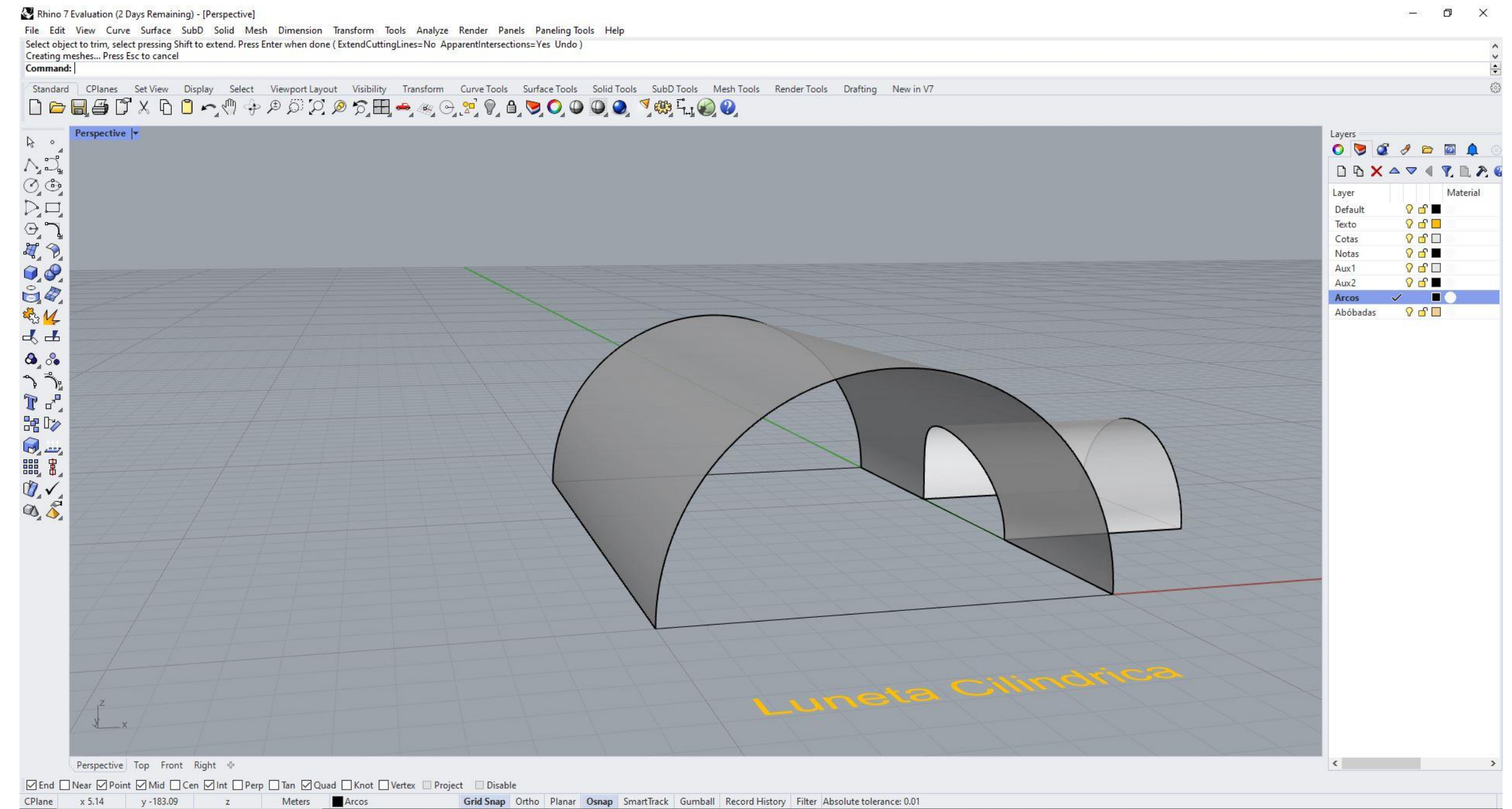
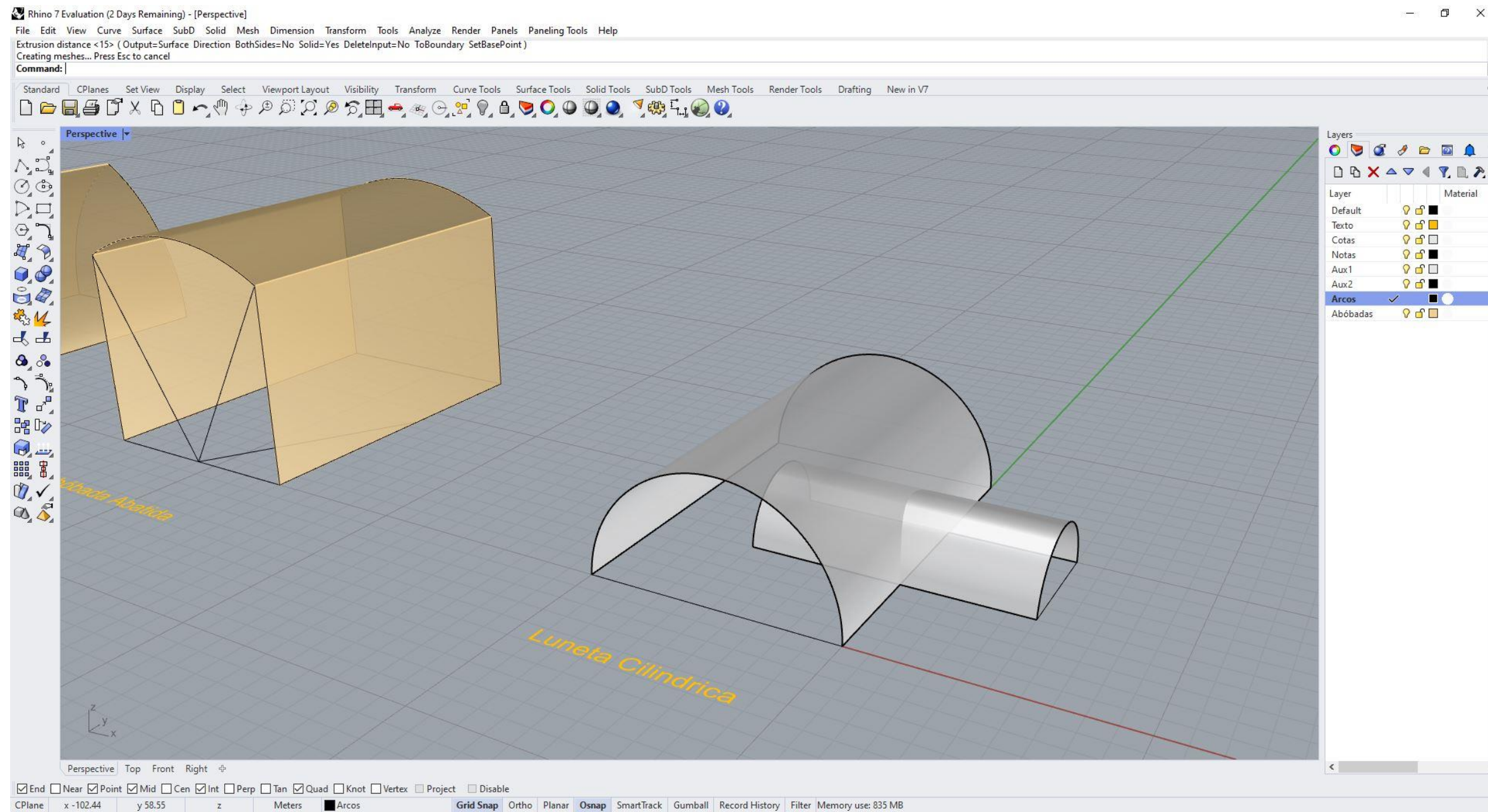

Exerc. 9.7 – Luneta Cilíndrica(Processo)

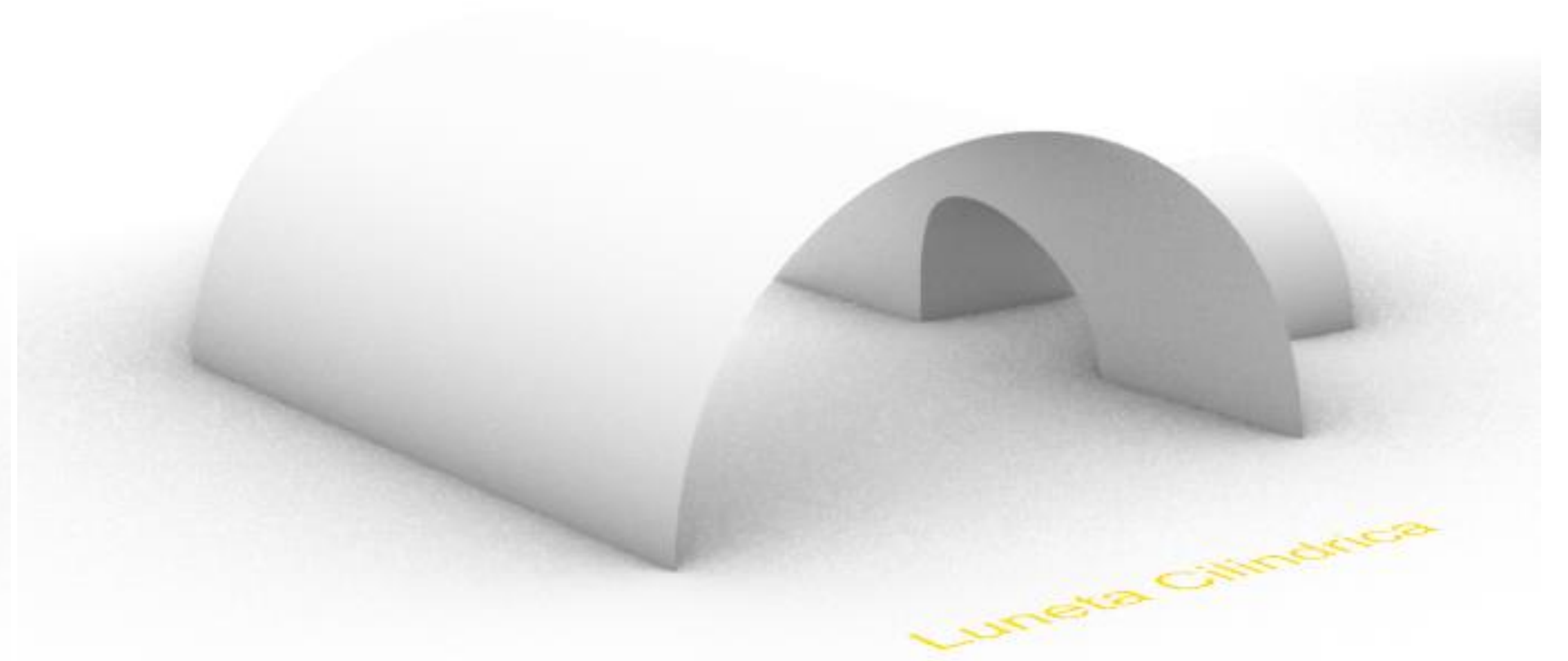
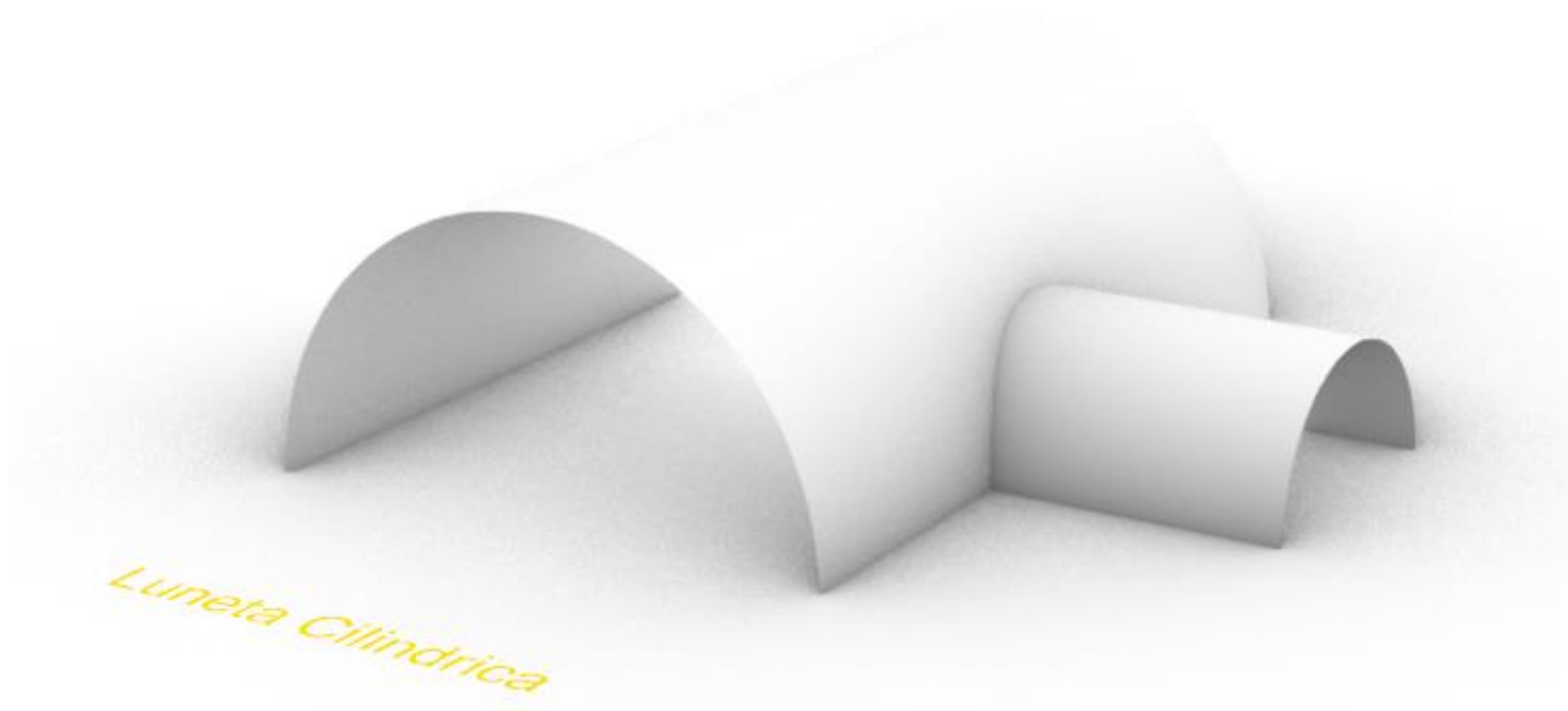

Exerc. 9.7 – Luneta Cilíndrica

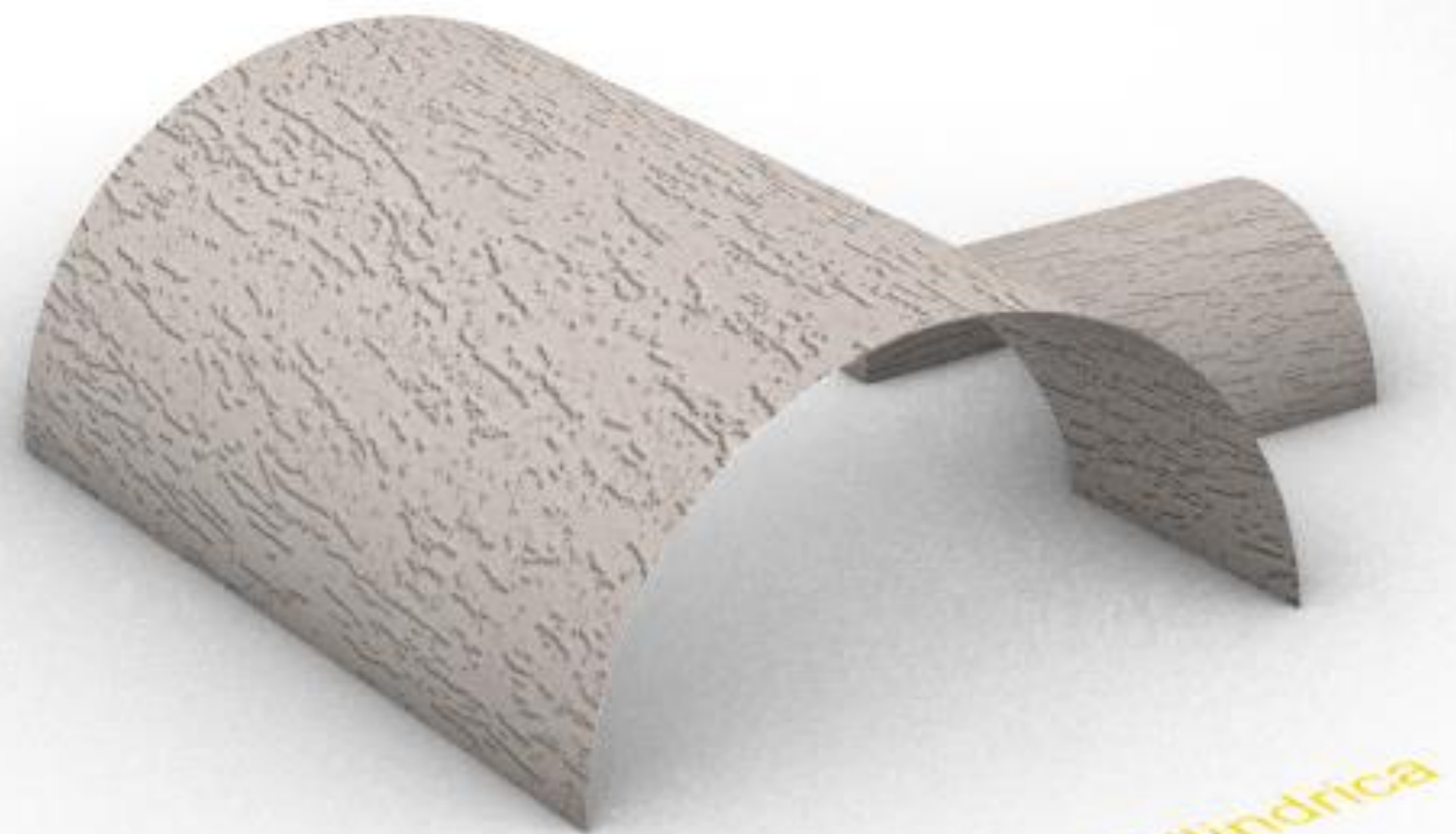

Luneta Cilíndrica



Luneta Cilíndrica

Exerc. 9.7 – Luneta Cilíndrica

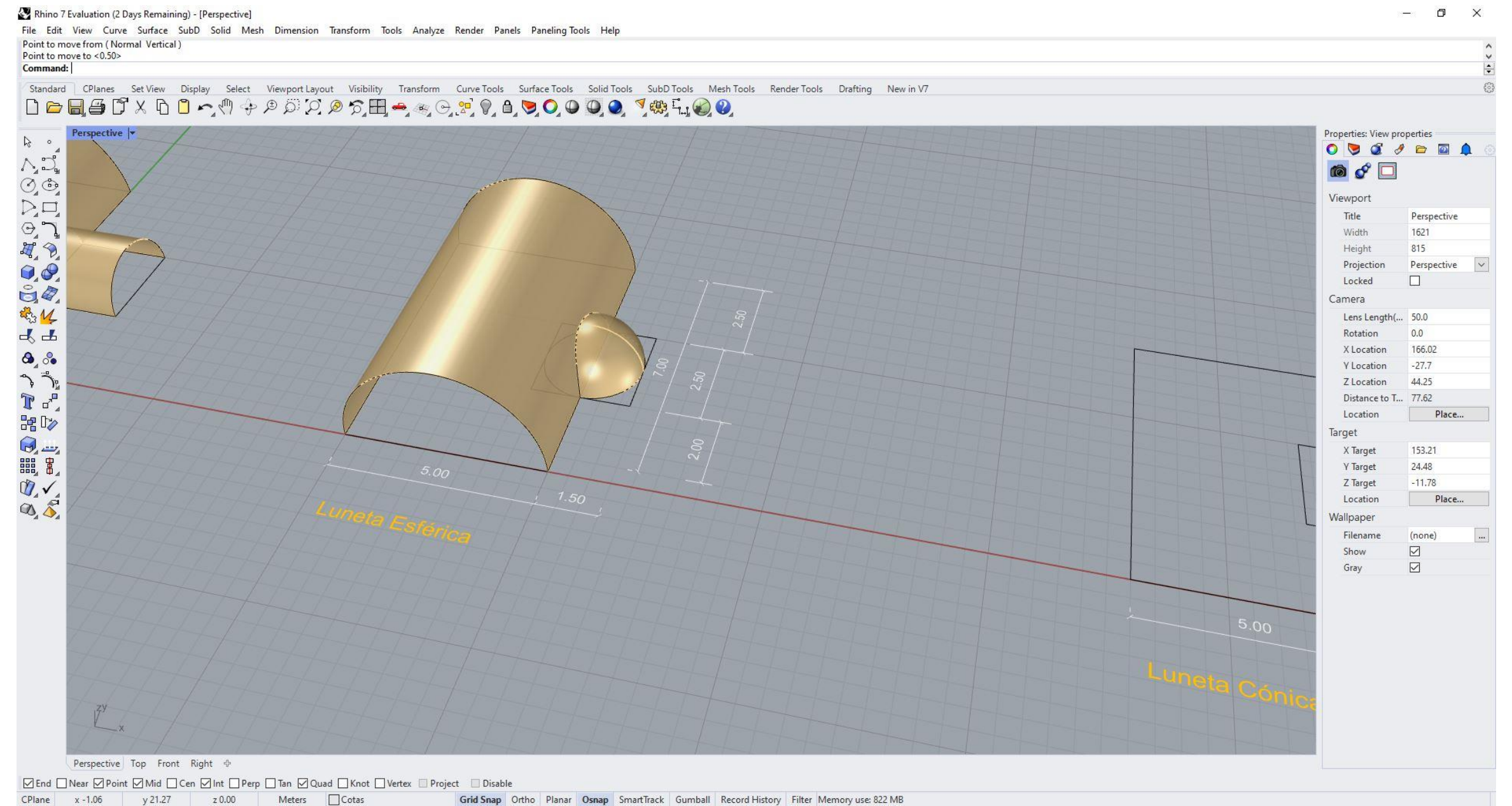
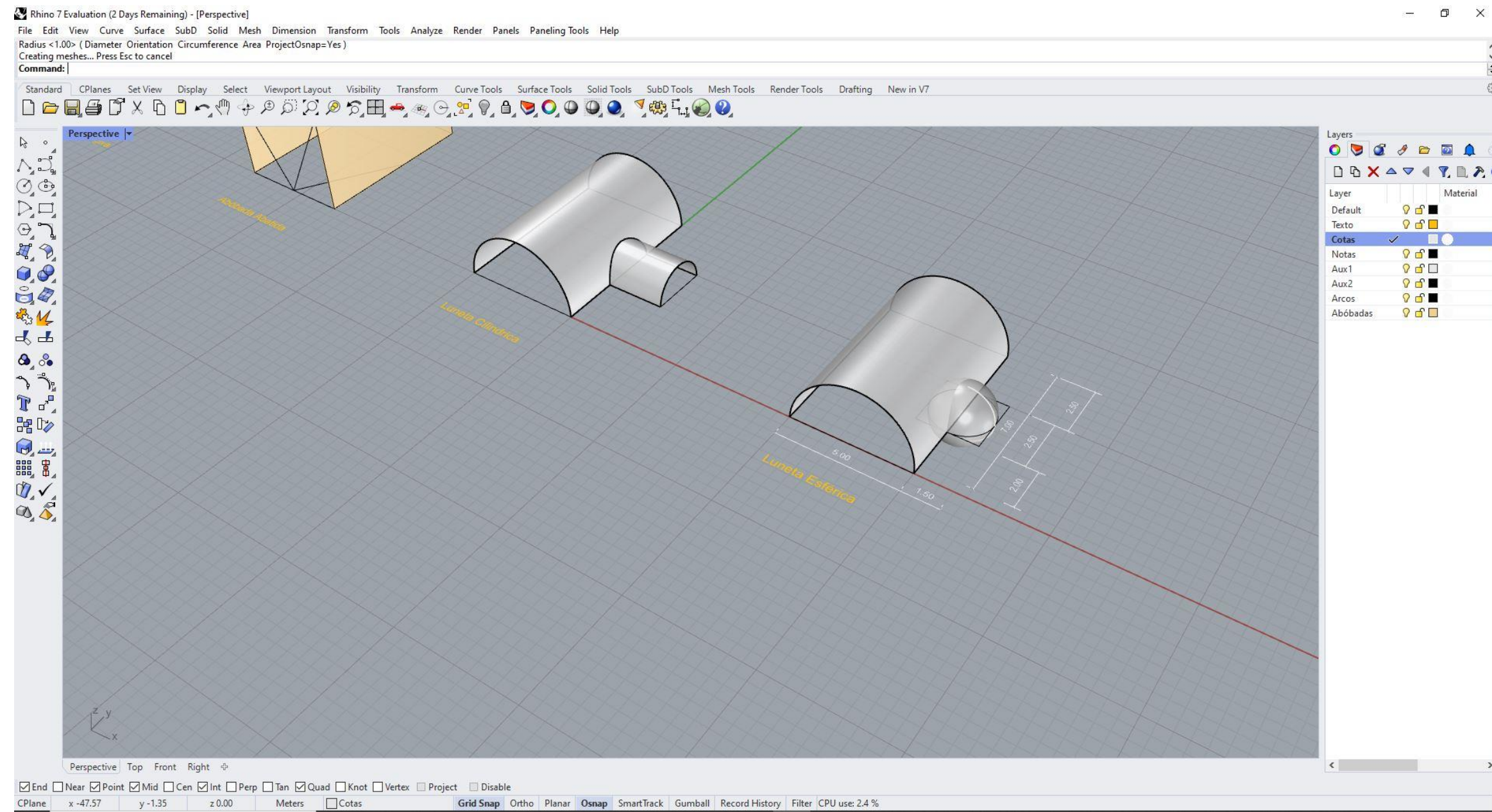

Exerc. 9.8 – Luneta Esférica (Processo)

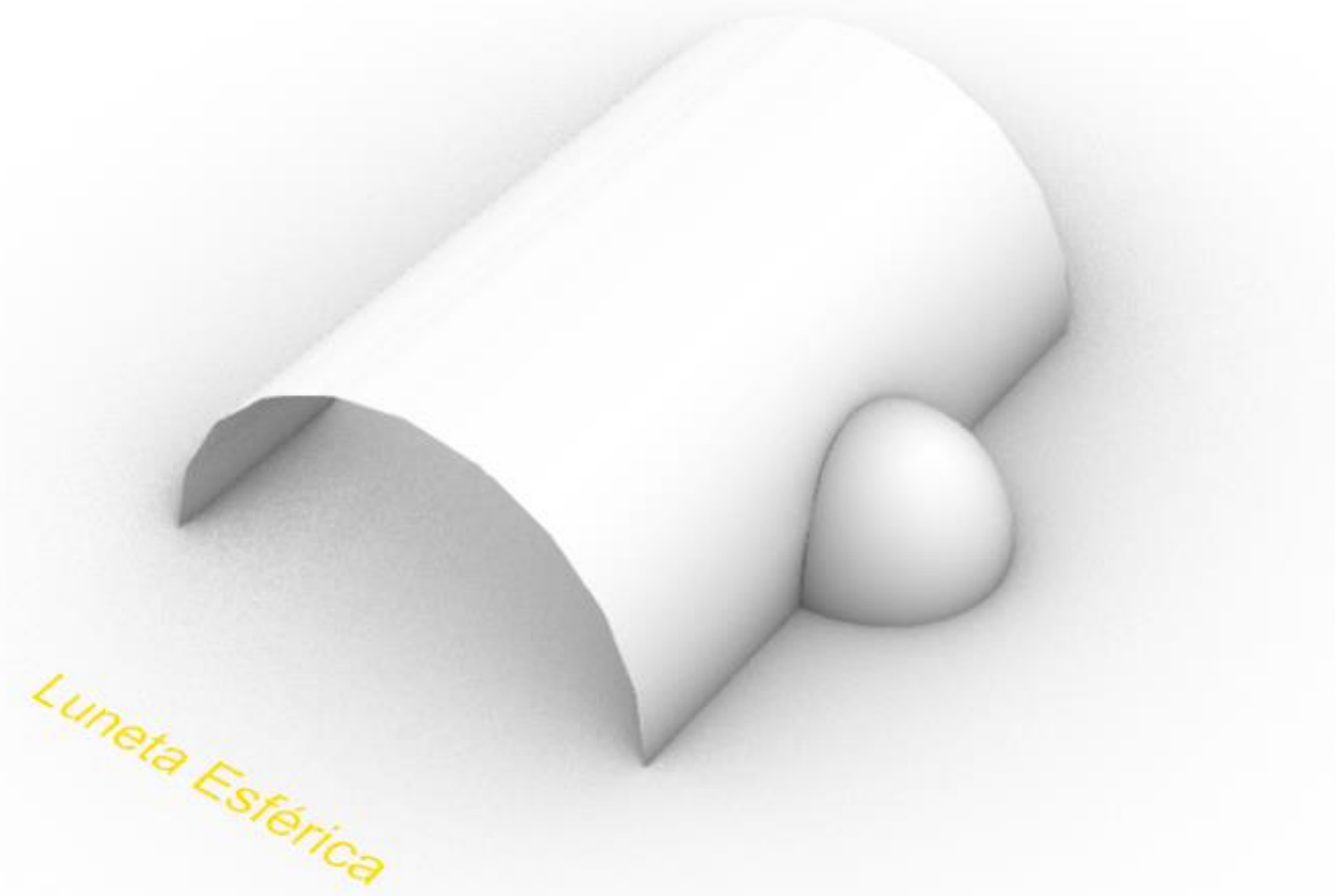
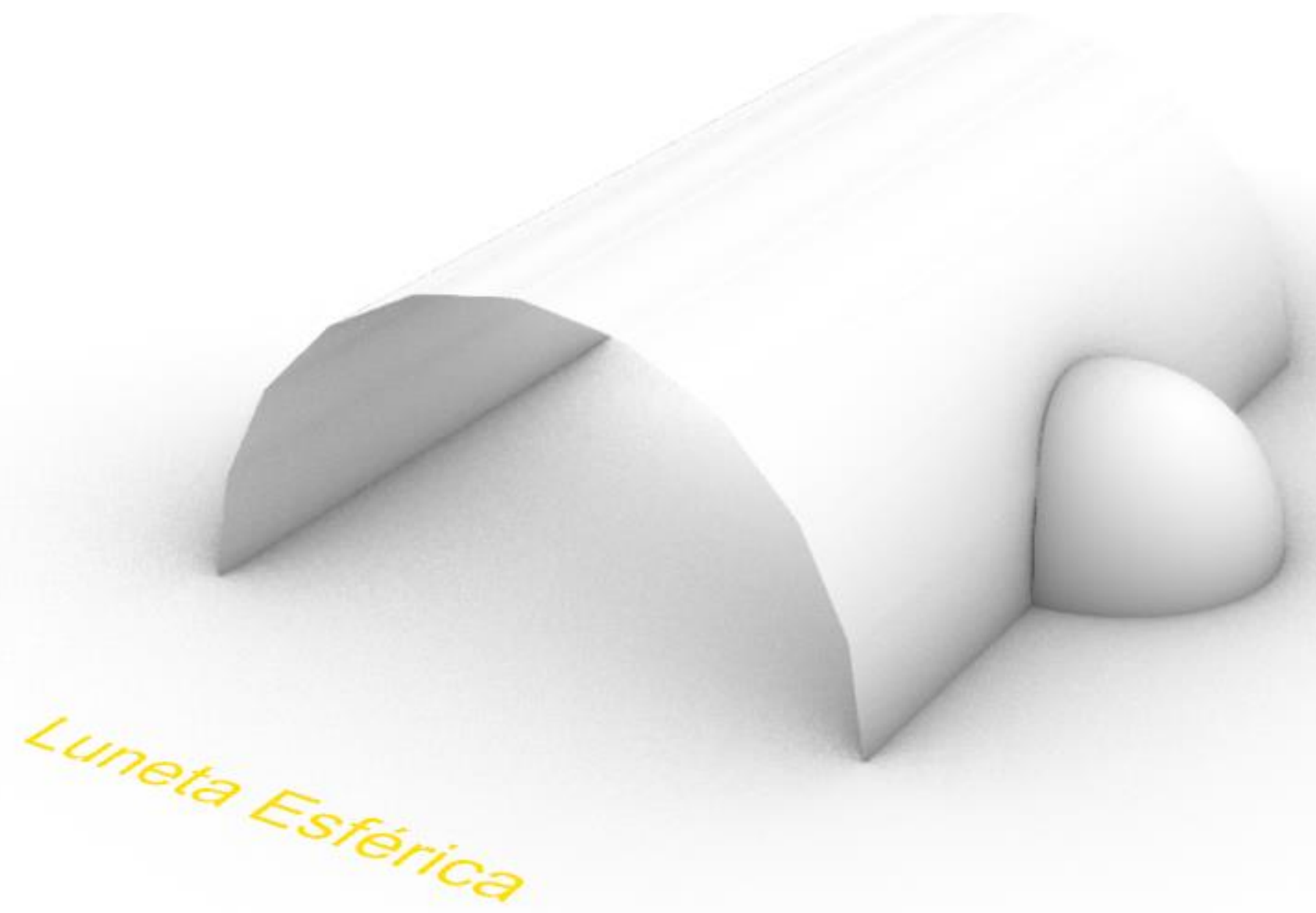

Exerc. 9.8 – Luneta Esférica

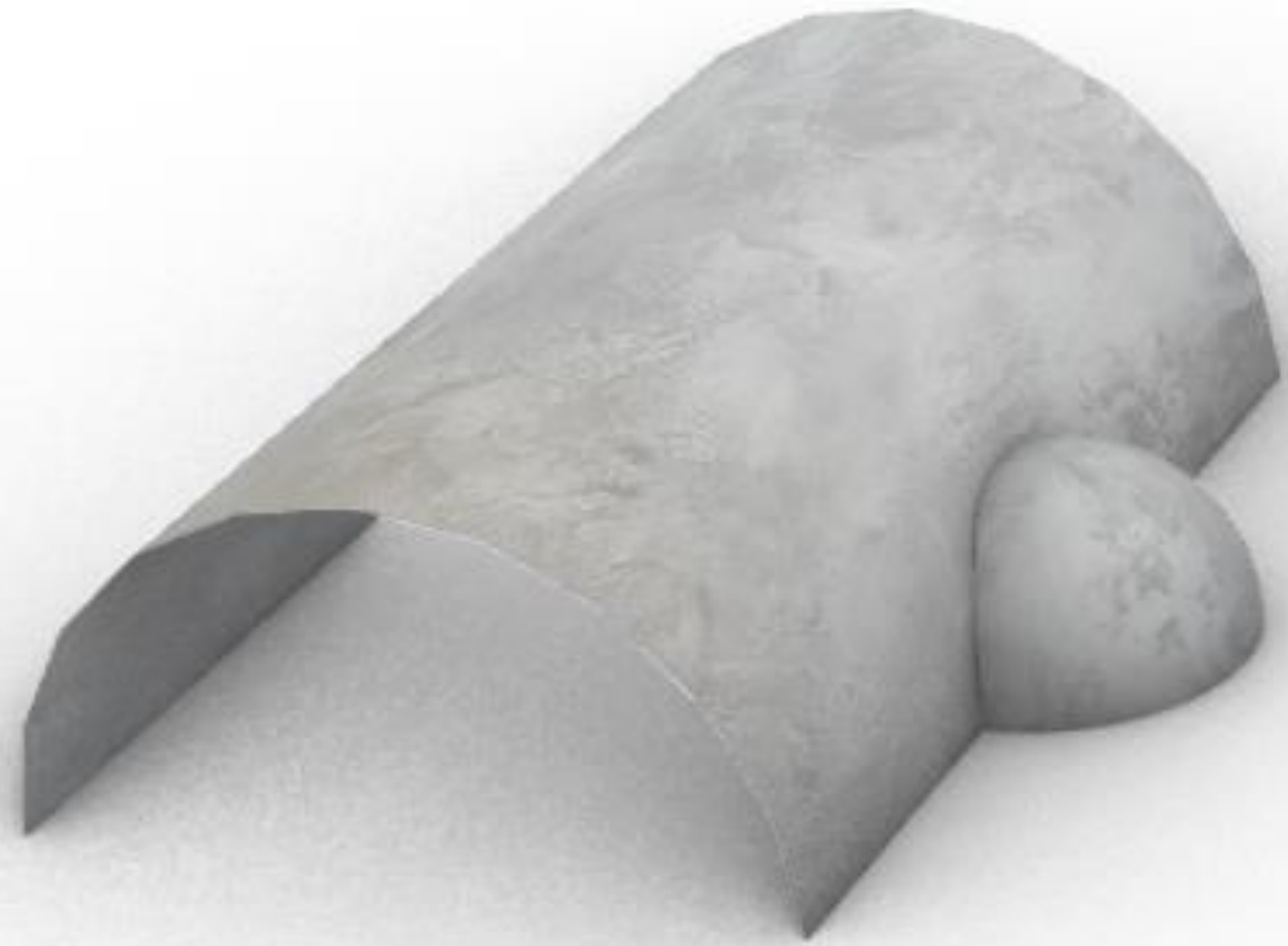

Luneta Esférica



Luneta Esférica

Exerc. 9.8 – Luneta Esférica

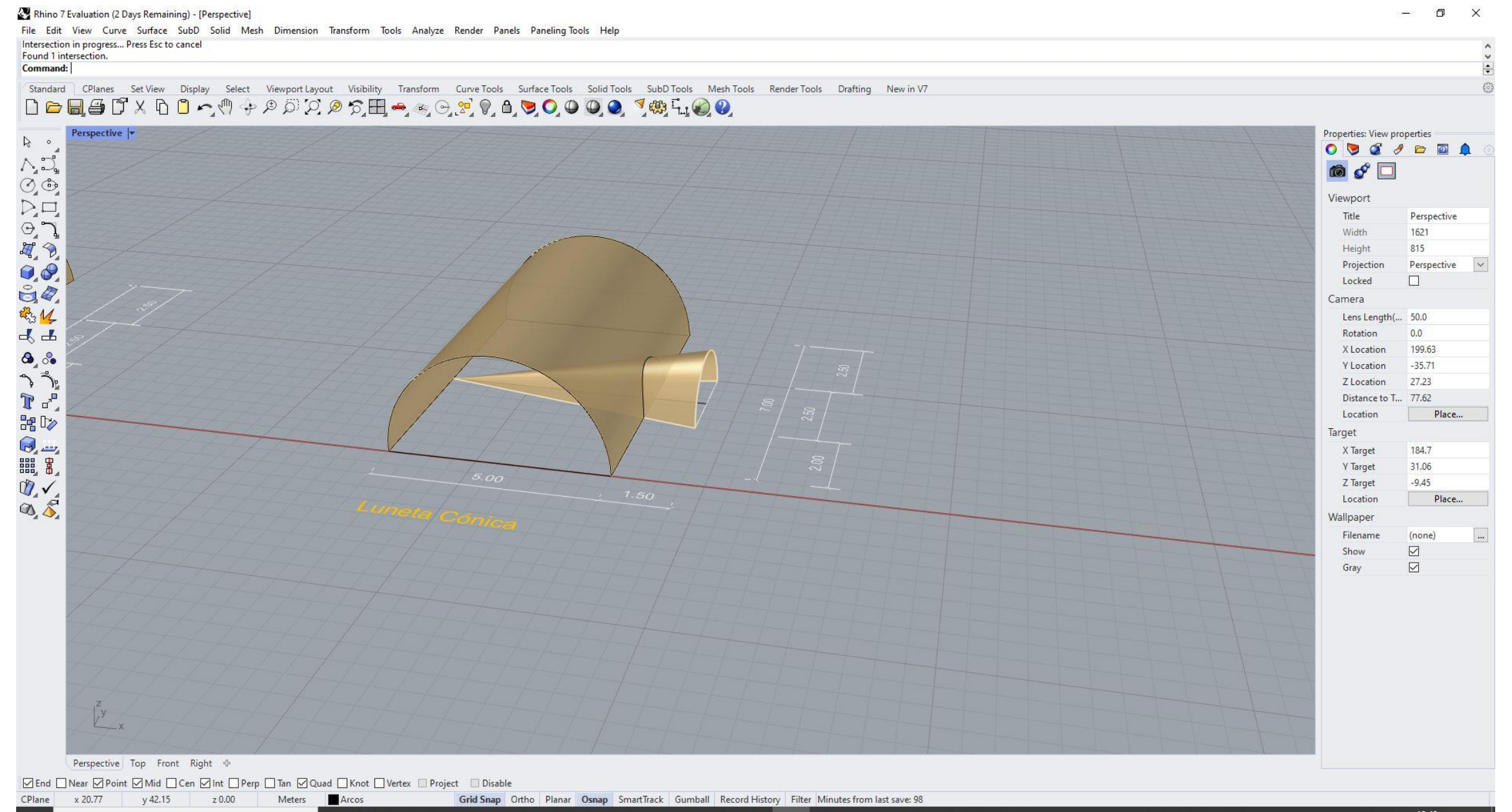
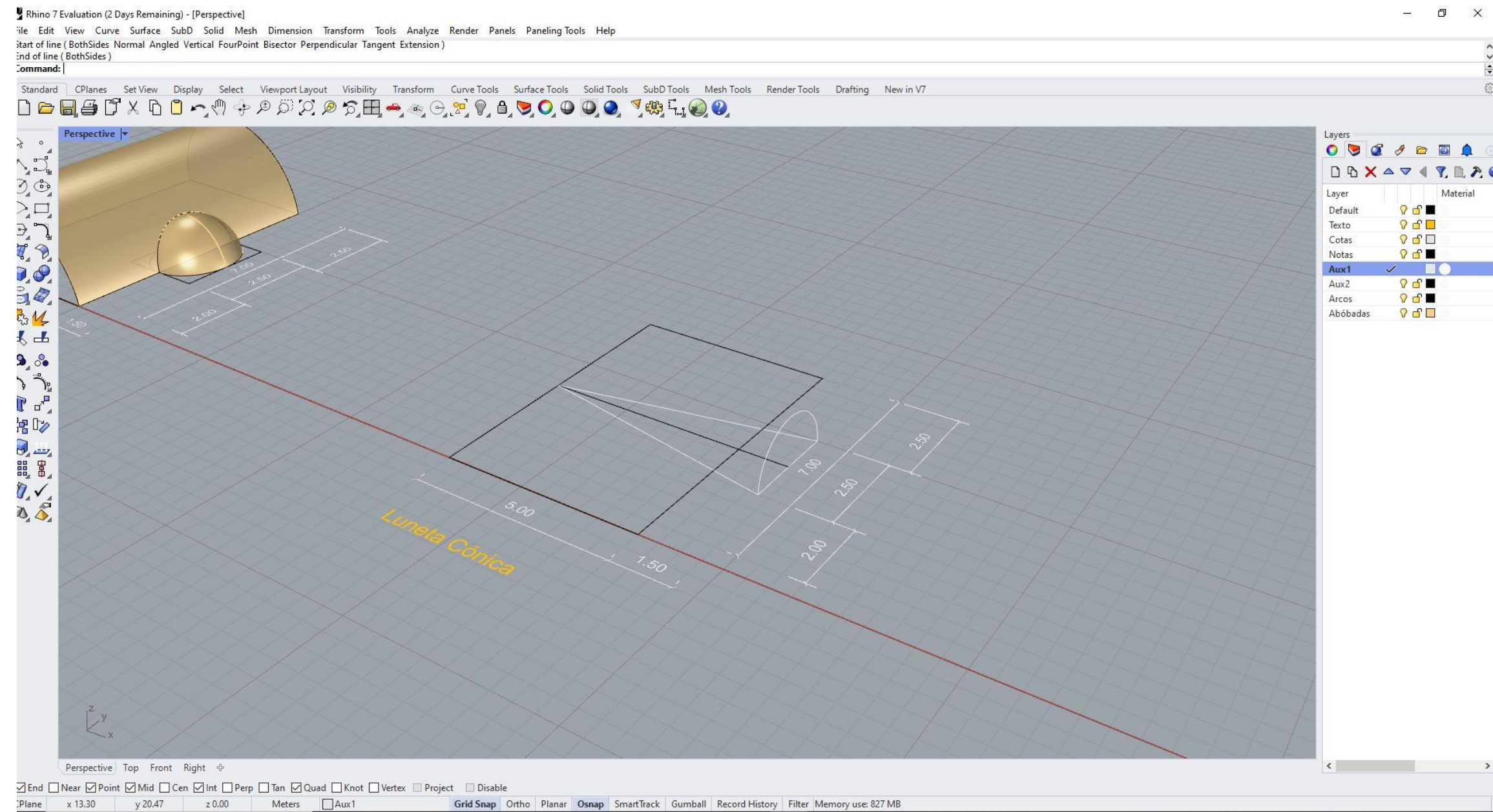

Exerc. 9.9 – Luneta Cónica (Processo)

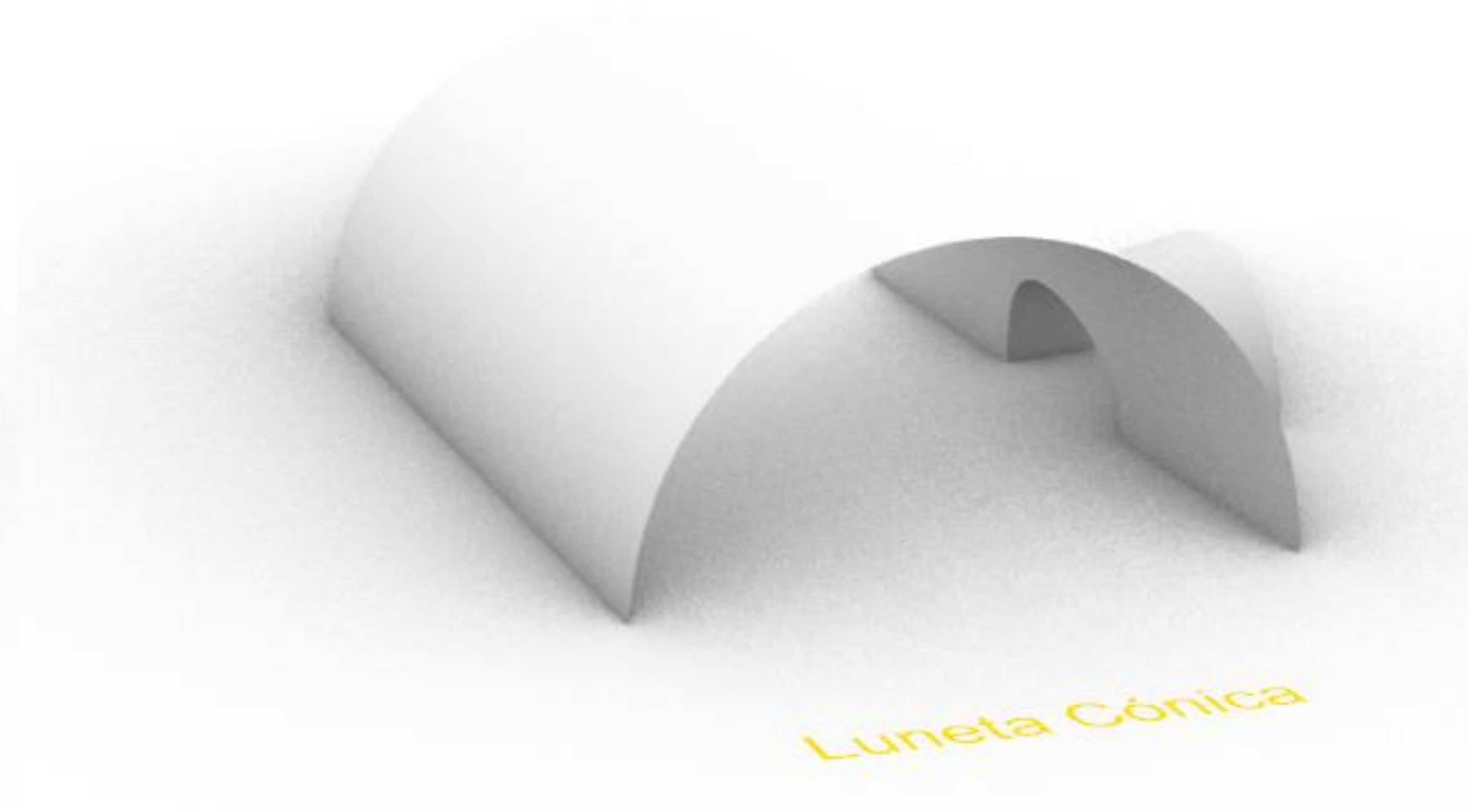
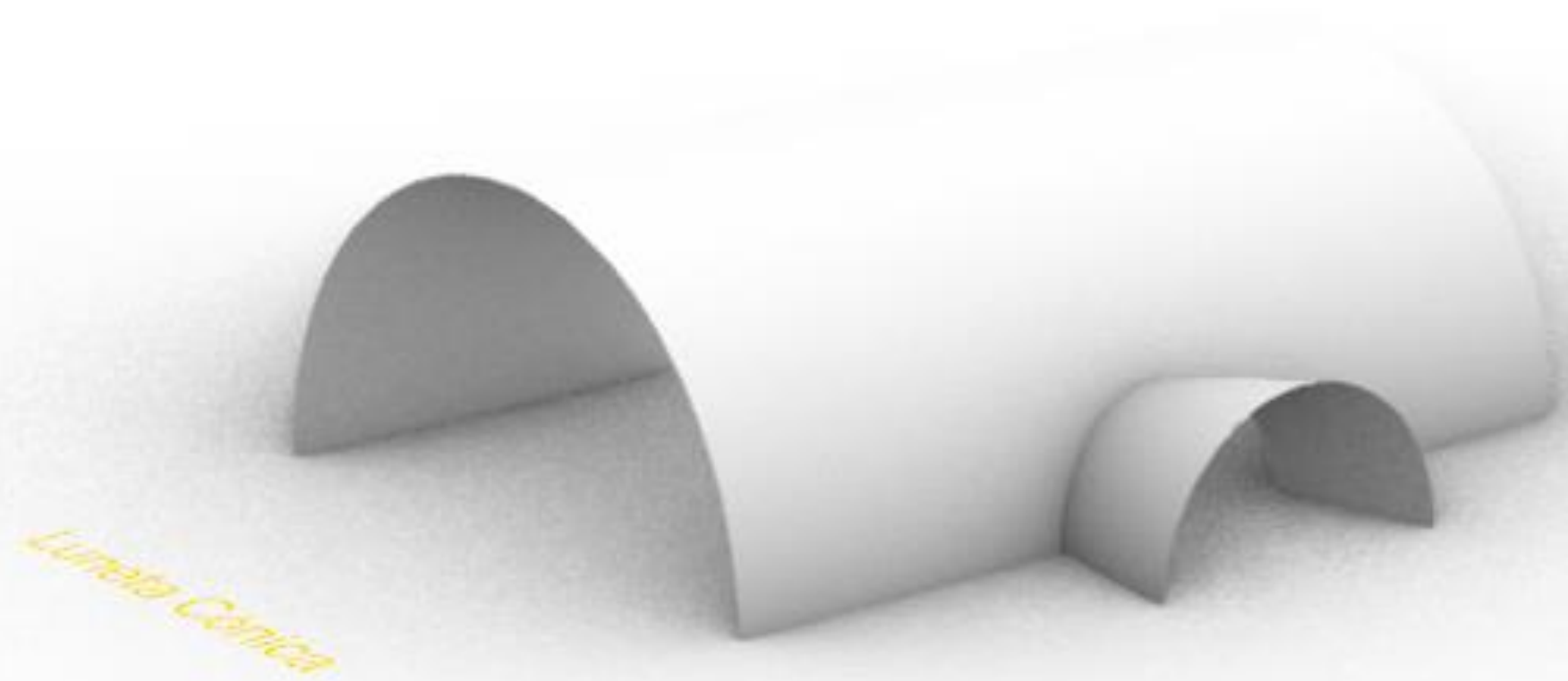

Exerc. 9.9 – Luneta Cónica



Luneta Cónica



Luneta Cónica

Exerc. 9.9 – Luneta Cónica