

ALÇADO LATERAL
1:100

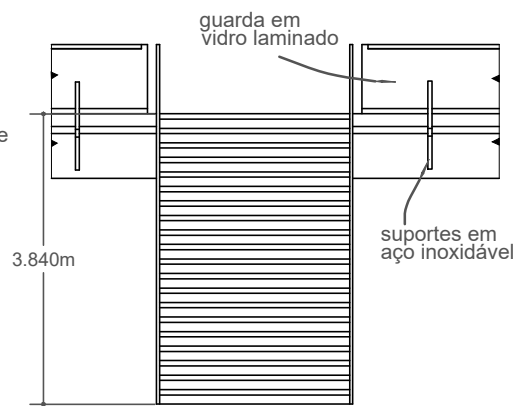

ALÇADO FRONTAL
1:100

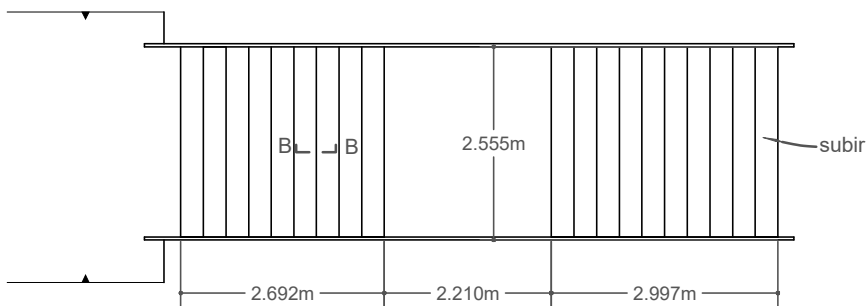

PLANTA
1:100

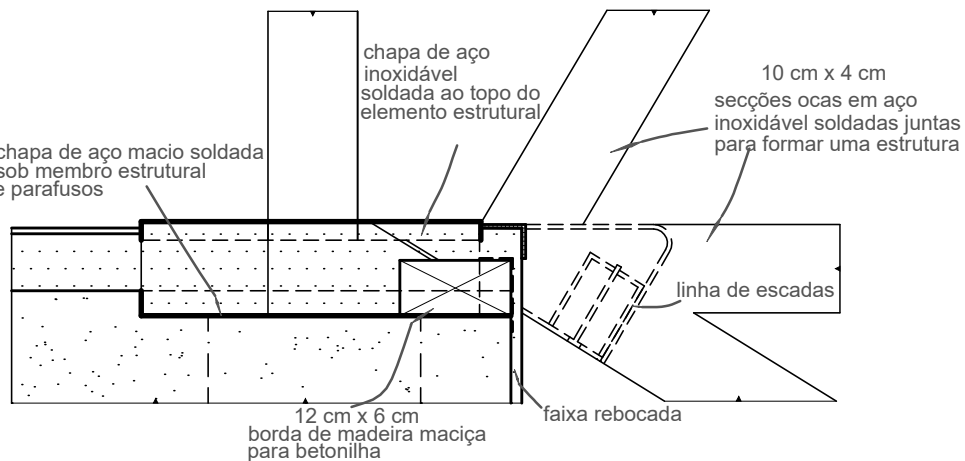
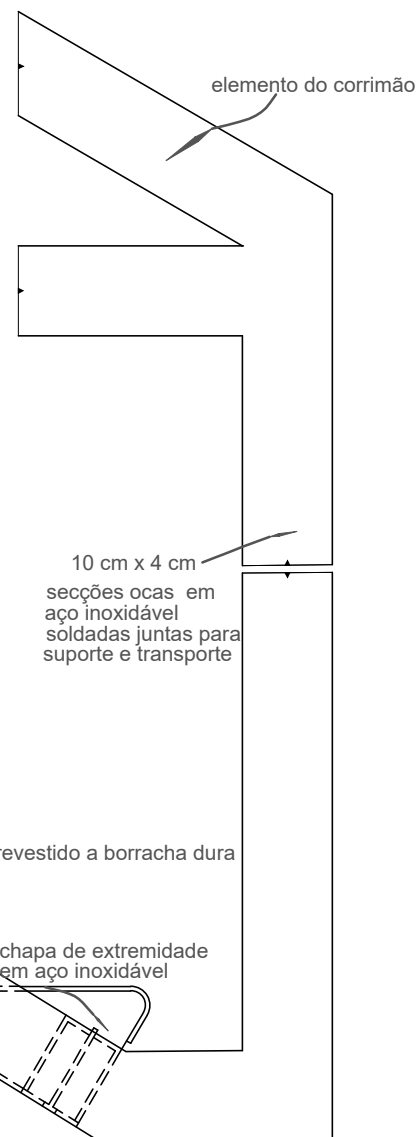

DETALHE A
1:8

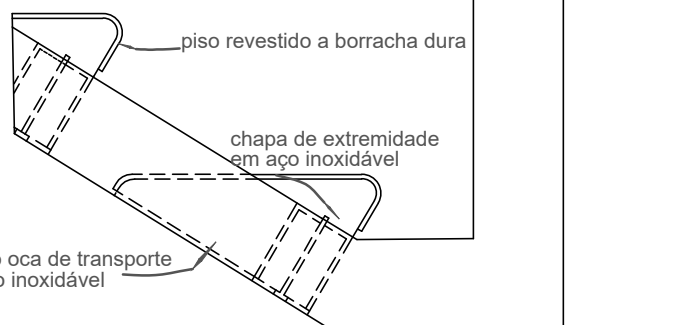

DETALHE C
1:8

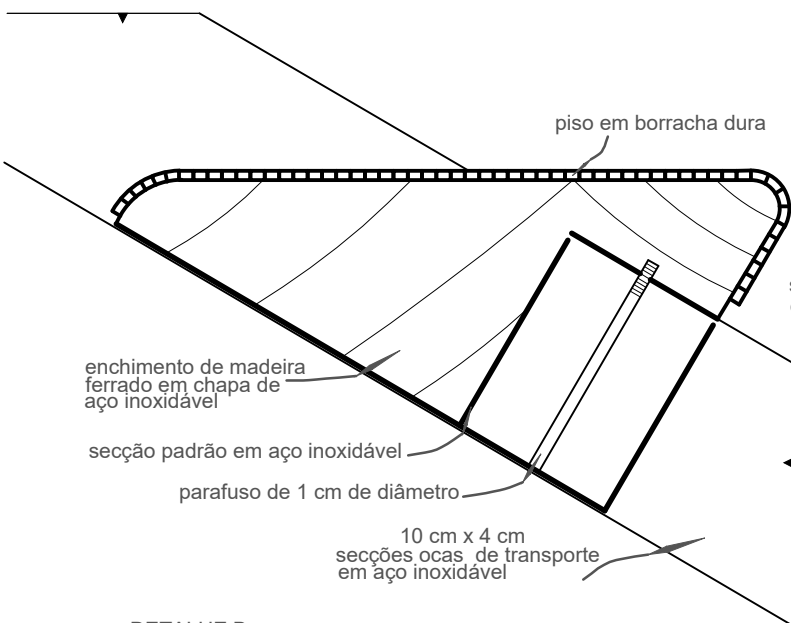
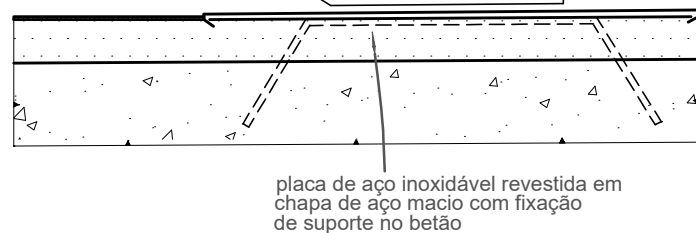

DETALHE B
1:4